

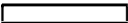

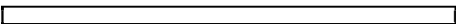

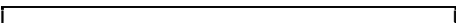

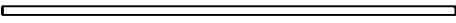



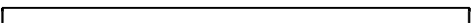

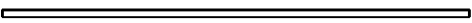
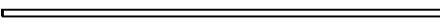

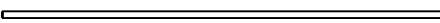
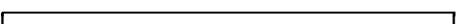



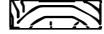
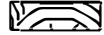
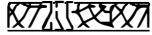
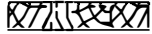

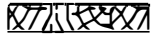



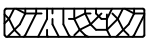
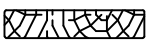
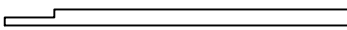

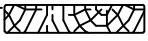
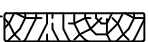





MODULARO™















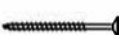

WOOD CABIN SET GENEVA

3 x 3 x 2.39 m



Pos	10.10.2019 Piece list - Stückliste - Liste des pièces - Elementi - Stuklijst - Tükitalabel Art. Nr. WC165562 2/20	Q	P (mm)	L (mm)
001		18	44x114	801
002		21	44x114	2912
003		2	44x114	2912
004		1	44x57	2912
005		18	44x114	1881
006		22	44x114	3000
007		2	44x114	3000
IAR1	Foundation - Fundament - Fondation - Fondamenta - Fundering - Immutatud alusraam 	4	45x70	3000
IAR3	Foundation - Fundament - Fondation - Fondamenta - Fundering - Immutatud alusraam 	8	45x70	2820
IAR2	Foundation - Fundament - Fondation - Fondamenta - Fundering - Immutatud alusraam 	3	45x70	100
RV1	Lath - Pfetten - Liteau - Piccola asse - Gordingen - Roov 	1	44x44	2796
A-PR1	Roof beam - Dachbalken - Panne de toit - Perlina del tetto - Gordingen / dakbalk - Pärilin 	4	44x140	2904
FB	Floor boards - Fussbodenbretter - Lame de plancher - Pavimento - Vloerhout - Põrandalaud 	33	90x18	2908
DB	Roof boards - Dachbretter - Voliges - Perlina per tetto - Dakhout - Katuselaud 	33	90x18	3000
	Floor fillet - Fussbodenleiste - Corniere de finition du plancher - Finitura per pavimento (battisco pa) - Vloerafwerklijst - Põrandaliist 		18x18	11.63
DPL2	Roofing felt fillet - Dachpappenleiste - Baguette de fixation du feutre bitumeux - Asse per fissaggio guaina bituminosa - Afdeklijst asfaltpapier - Katusepapiiist 	2	18x58	3138
DPL1	Roofing felt fillet - Dachpappenleiste - Baguette de fixation du feutre bitumeux - Asse per fissaggio guaina bituminosa - Afdeklijst asfaltpapier - Katusepapiiist 	1	18x58	3196
RS1	Railing strip - Begrenzungsleiste - Rembarde - Sbarra - Afscheidingslijst - Piirdelaud 	1	18x70	1975
RS2	Railing strip - Begrenzungsleiste - Rembarde - Sbarra - Afscheidingslijst - Piirdelaud 	1	18x70	1982
RS3	Railing strip - Begrenzungsleiste - Rembarde - Sbarra - Afscheidingslijst - Piirdelaud 	1	18x70	1993
RS4	Railing strip - Begrenzungsleiste - Rembarde - Sbarra - Afscheidingslijst - Piirdelaud 	1	18x70	2000
RS5	Railing strip - Begrenzungsleiste - Rembarde - Sbarra - Afscheidingslijst - Piirdelaud 	1	18x90	1065
RS6	Railing strip - Begrenzungsleiste - Rembarde - Sbarra - Afscheidingslijst - Piirdelaud 	1	18x90	1075

Pos	10.10.2019 Piece list - Stückliste - Liste des pièces - Elementi - Stuklijst - Tükítabel Art. Nr. WC165562 3/20	Q	P (mm)	L (mm)
RS7	Railing strip - Begrenzungsleiste - Rembarde - Sbarra - Afscheidingslijst - Piirdelaud 	1	18x90	2116
RS8	Railing strip - Begrenzungsleiste - Rembarde - Sbarra - Afscheidingslijst - Piirdelaud 	1	18x90	2126
P	Post - Pfosten - Poteau - Piede registrabile - Stijl - Post 	1	88x44	2330
P1	Post - Pfosten - Poteau - Piede registrabile - Stijl - Post 	1	44x44	2260
P2	Post - Pfosten - Poteau - Piede registrabile - Stijl - Post 	3	70x70	2330
TB2	Fascia board - Traufbrett - Bandeau de toit - Finitura lati tetto - Gevellijst - Räästalaud 	2	18x120	3160
TB1	Fascia board - Traufbrett - Bandeau de toit - Finitura lati tetto - Gevellijst - Räästalaud 	2	18x120	3196
DRV-1	Roof edge reinforcement - Dachrandverstärkung - Corniere de renfort de bord de toit - Rinforzo x tetto - Dakrand versterking - Räästatugevdus 	2	80x44	3000
DRV-2	Roof edge reinforcement - Dachrandverstärkung - Corniere de renfort de bord de toit - Rinforzo x tetto - Dakrand versterking - Räästatugevdus 	2	80x44	3160
FF2	Fixing fillet - Fixierungsleiste - Profil de fixation - Massello di fissaggio - Bevestiging lijstwerk - Tenderliist 	1	15x45	2026
FF	Fixing fillet - Fixierungsleiste - Profil de fixation - Massello di fissaggio - Bevestiging lijstwerk - Tenderliist 	2	18x44	2030
FF3	Fixing fillet - Fixierungsleiste - Profil de fixation - Massello di fissaggio - Bevestiging lijstwerk - Tenderliist 	1	38x46	1980
FF4	Fixing fillet - Fixierungsleiste - Profil de fixation - Massello di fissaggio - Bevestiging lijstwerk - Tenderliist 	2	38x46	2026
HS32	Screw for door jamb - Schraube für türrahmen - Vis de fixation partie haute avec montants du cadre de porte - Viti x fissaggio montanti porte - Schroef voor deurkozijn - Kruvi ukse lengile 	2	4.5x25	
HS14	Screw for wall details - Schraube für wand details - Vis pour mur details - Viti per elementi della porta - Schroef voor wand details - Kruvi seinte montaažiks 	310	4.5x80	
HS12	Screw for doorstep - Schrauben für swelle - Vis pour fixation barre de seuil - Vite per soglia della porta - Schroef voor deurdorpel - Kruvi lävepakule 	3	4x40	
HS12	Screw for covering moulding - Schrauben für deckungsprofil - Vis de fixation profils horizontaux haut intérieur et extérieur d'encadrement de porte - Vite per cornice di copertura - Schroef voor afdekprofiel - Kruvi piirdelauale 	30	4x40	
HS12	Screw for fascia boards - Schrauben für traufbretter - Vis pour fixation bandeau de toit - Viti x striscia del tetto - Schroef voor gevellijst - Kruvi räästalauale 	32	4x40	
HS12	Screw for beam holder - Schrauben für balkenhalter - Vis de fixation support "u" galvanisé - Vite per trave di sostegno - Schroef voor bevestiging balkhouder (gordingschoen) - Kruvi talakingale 	96	4x40	
HS12	Screw for metal corner - Holzschraube für metallwinkel - Vis de fixation des cornieres en métal - Viti per fissare suadretta di metallo di giunzione - Schroef voor metalen hoek - Kruvi nurgikule 	20	4x40	
HS12	Screw for fixing fillet of door and window - Schrauben für fixierungsleiste - Vis pour profil vertical de fixation pour ouvertures des fenetres et portes - Viti per massello di fissaggio - Schroeven voor bevestiging van deur en raam lijsten - Kruvi tenderliistudele 	36	4x40	
HS12	Screw for door jamb - Schraube für türrahmen - Vis de fixation partie haute avec montants du cadre de porte - Viti x fissaggio montanti porte - Schroef voor deurkozijn - Kruvi ukse lengile 	9	4x40	
HS33	Screw for door jamb - Schraube für türrahmen - Vis de fixation partie haute avec montants du cadre de porte - Viti x fissaggio montanti porte - Schroef voor deurkozijn - Kruvi ukse lengile 	8	5x40	

Pos	10.10.2019 Piece list - Stückliste - Liste des pièces - Elementi - Stuklijst - Tükitalabel Art. Nr. WC165562 4/20	Q	P (mm)	L (mm)
HS16	Screw for foundation - Schrauben zur befestigung fundament - Vis de fixations des poutrelles de fondations - Viti x fundamenta - Schroef voor fundering - Kruvi alusraamile 	16	5x90	
HS16	Screw for post - Schrauben für pfosten - Vis de fixation des poteaux - Viti per inviare - Schroef voor stijlen - Kruvi postile 	9	5x90	
HS16	Screw for roof edge reinforcement - Schrauben für dachrandverstärkung - Vis pour fixation corniere renfort de bord de toit - Viti x rinforzo bordo tetto - Schroef voor dakrand versterking - Kruvi räästatugevdusele 	28	5x90	
HS16	Screw for wall details - Schraube für wand details - Vis pour mur details - Viti per elementi della porta - Schroef voor wand details - Kruvi seinadetailidele 	4	5x90	
HS16	Screw for foundation - Schrauben zur befestigung fundament - Vis de fixations des poutrelles de fondations - Viti x fundamenta - Schroef voor fundering - Kruvi alusraamile 	11	5x90	
HS16	Screw for door jamb - Schraube für türrahmen - Vis de fixation partie haute avec montants du cadre de porte - Viti x fissaggio montanti porte - Schroef voor deurkozijn - Kruvi ukse lengile 	8	5x90	
HS22	Screw for 1. wall beam - Schraube für 1. bohlenreihe - Vis de fixations 1ere rangée de madriers avec poutrelles de fondations - Vite fissaggio alle fondamenta - Schroef voor 1 wandbalk - Kruvi poollauale 	11	6x150	
HS23	Screw for wall details - Schraube für wand details - Vis pour mur details - Viti per elementi della porta - Schroef voor wand details - Kruvi seinadetailidele 	78	6x180	
HS21	Screw for beam - Schrauben zur befestigung dachsparren - Vis pour solive - Viti per perline - Schroef voor balk (gording) - Kruvi talale 	10	6x80	
NF2	Zn nail for floor fillet - Zn nagel für fussbodenleiste - Pointe pour corniere de finition du plancher - Chiodi x fissaggio pavimento - Spijker(nagel) voor vloer afdekljst - Nael põrandaliistule 	25	1.4x40	
SH44	Hammer block - Schlagholz - Calle de frappe - Blocco di legno da usare come cuscinetto quando si usa il martello - Slagklos - Löögiklots 	1		
NF4	Zn nail for roof - Zn nagel für dachbretter - Pointe pour fixation voliges de toit - Chiodi x perline tetto - Spijker(nagel) voor dakhout - Nael katuselauale 	408	2x50	
NF4	Zn nail for floor - Zn nagel für fussbodenbretter - Clous pour plancher - Chiodi x perline pavimento - Spijker(nagel) voor vloer - Nael põrandalauale 	204	2x50	
MW	Metal corner - Metallwinkel - Corniere en métal - Angolo di metallo - Metalen hoek - Nurgik 	2	120x80x40	
NF5	Zn nail for roofing felt fillet - Zn nagel für dachpappenleiste - Pointe pour baguette de fixation feutre bitumeux - Chiodi x carta bituminosa x tetto - Spijker(nagel) voor asfaltpapier afdekljst - Papiliistunael 	24	2x40	
BM	Beam holder - Balkenhalter - Support en u galvanisé - Supporto della trave Balkendrager (gording schoen) - Talaking 	8	45x137	
	<p>To prevent splits in the wood, we recommend pre-drilling screw holes.</p> <p>Um der Rissbildung im Holz vorzubeugen, empfehlen wir, die Schraubenlöcher vorzubohren.</p> <p>Afin d'éviter le risque de fissuration du bois nous recommandons de percer auparavant les trous des vis.</p> <p>Per impedire avvitando le viti autofilettanti dell'insorgere di crepe nel legno, si consiglia di pre forare il legno con un trapano.</p> <p>Om scheuren van het hout te voorkomen, adviseren we om schroefgaten voor te boren.</p> <p>Ennetamaks puidu lõhenemist, soovitame kruviaugud ette puurida.</p> 			

Groundplan - Grundplan - Plan de masse -
Planimetria - Plattegrond - Põhiplaan

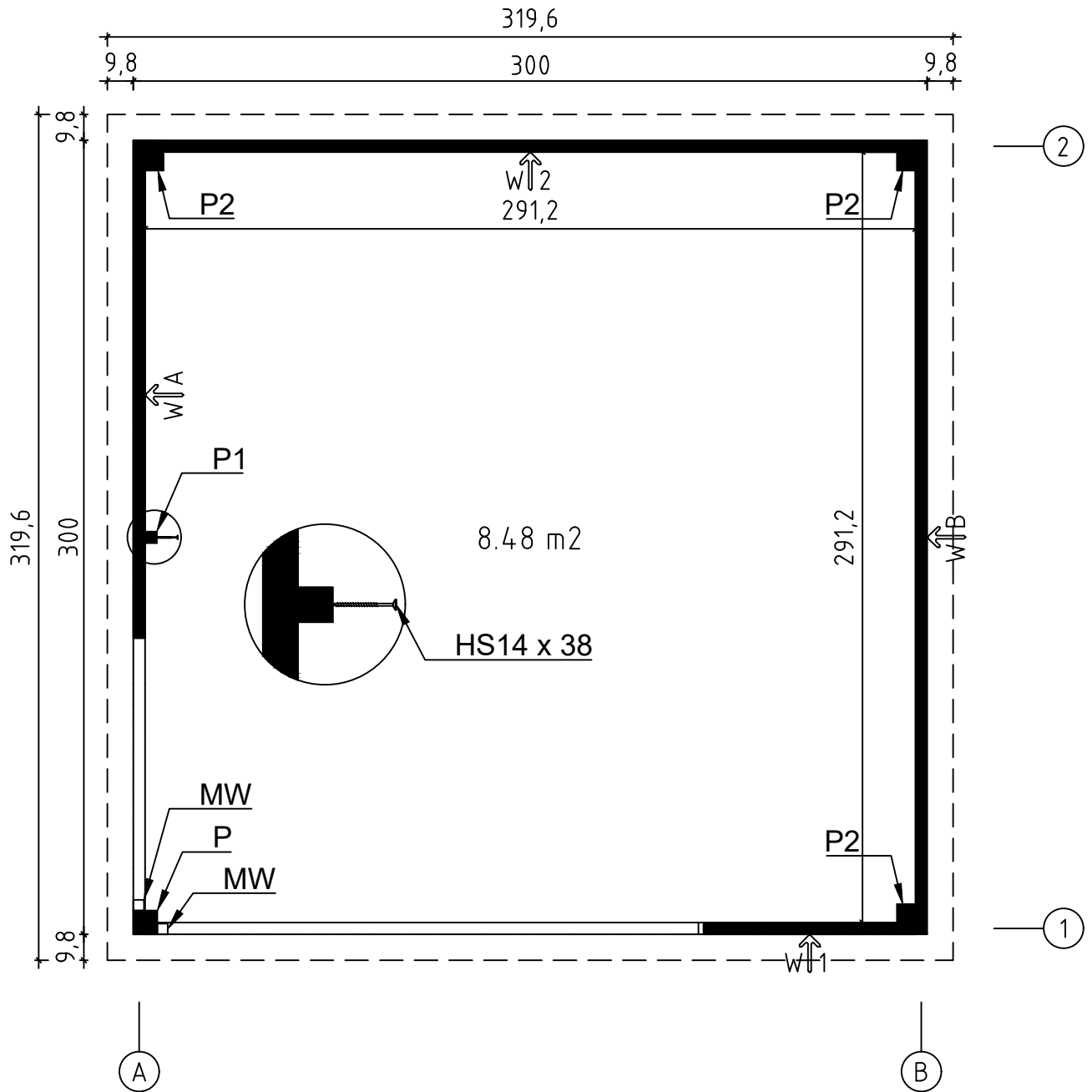

Foundation - Fundament - Fondation -
Fondamenta - Fundering - Immutatud alusraam

Floor boards - Fussbodenbretter - Plan pose plancher -
Pavimento - Vloerhout - Põrandalaudis

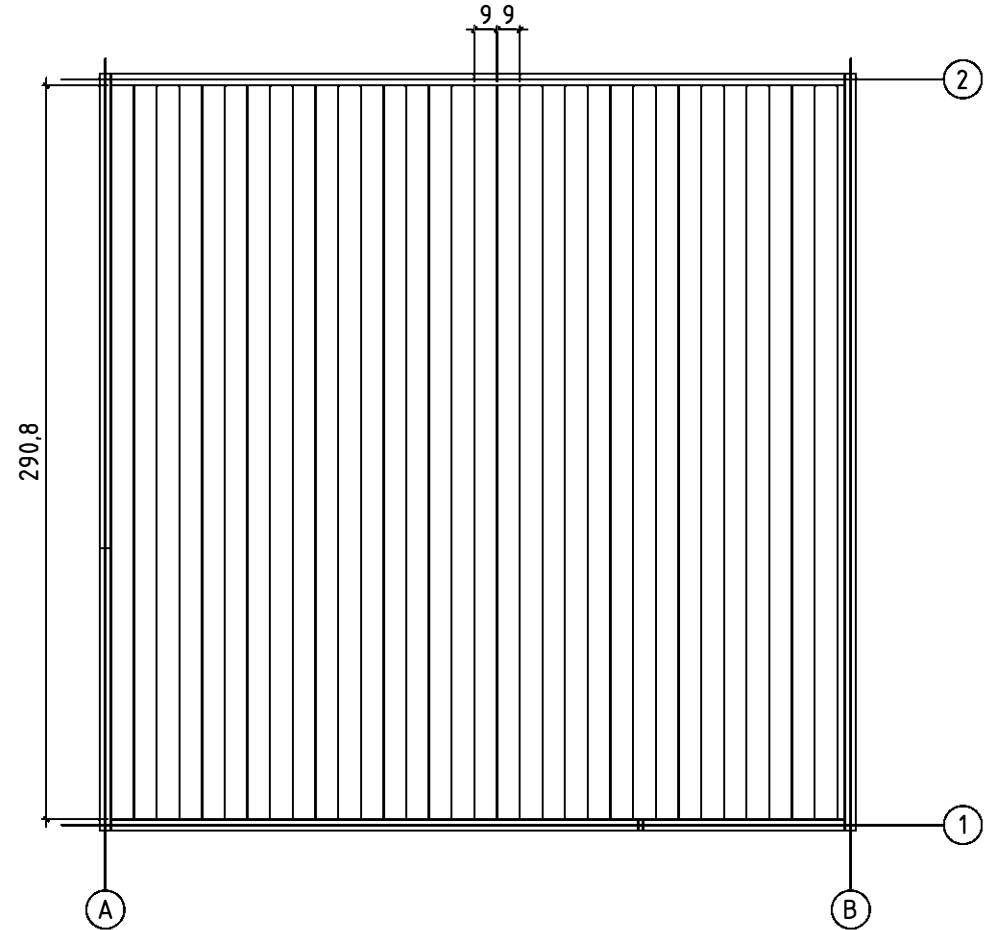
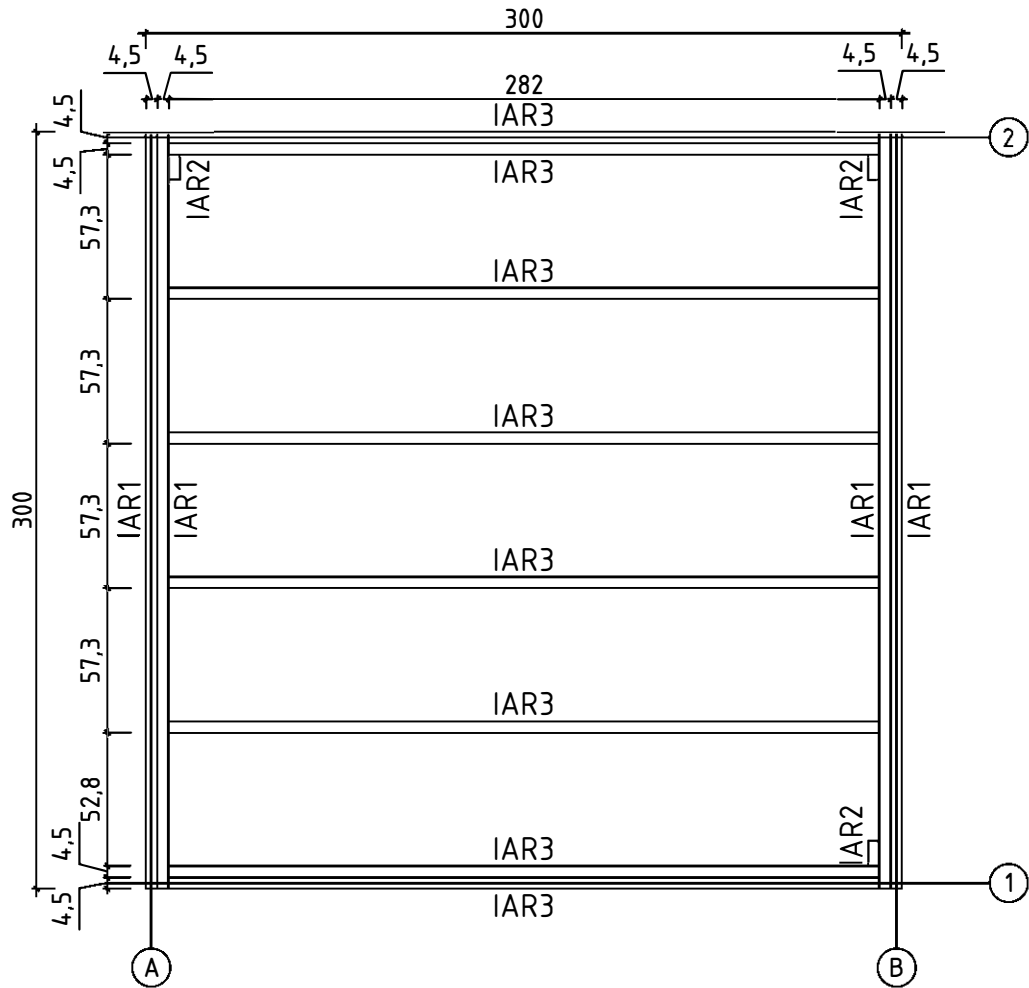

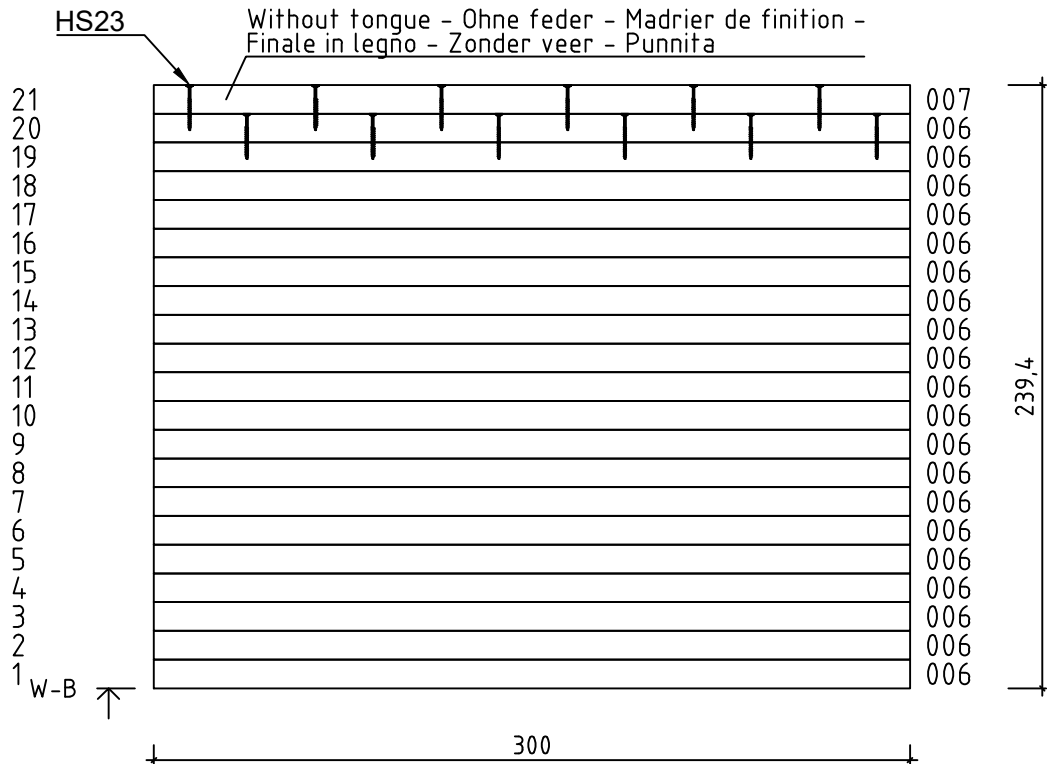
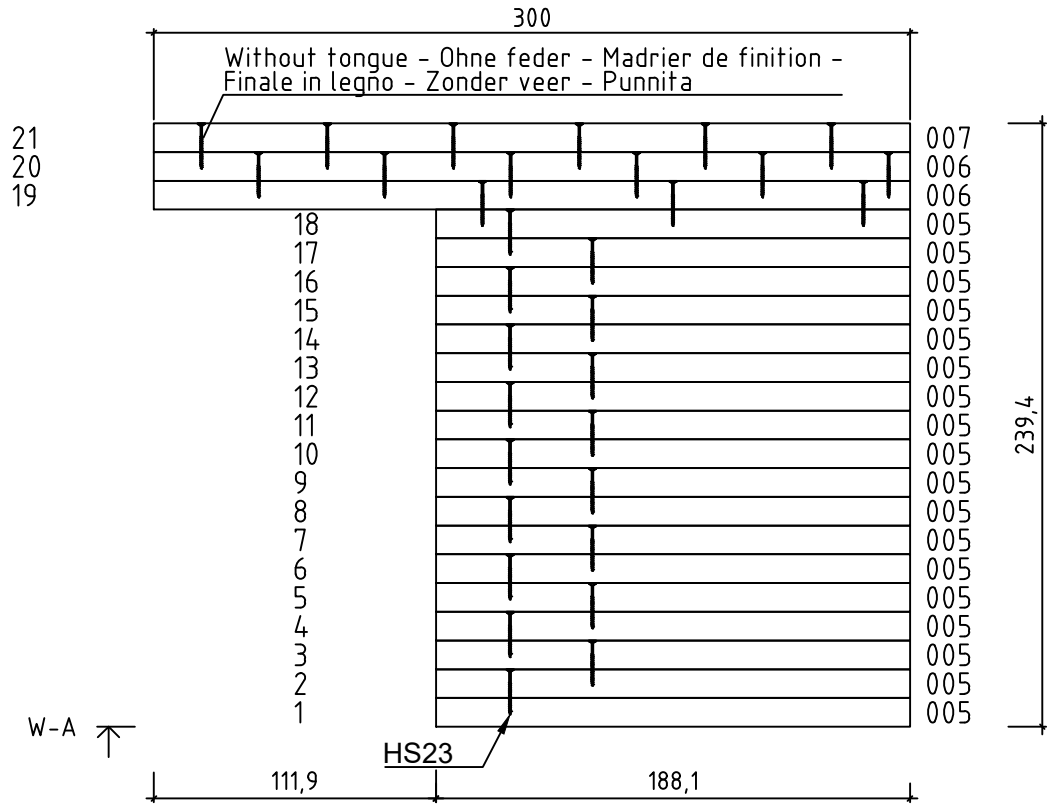

Art.Nr. WC165562

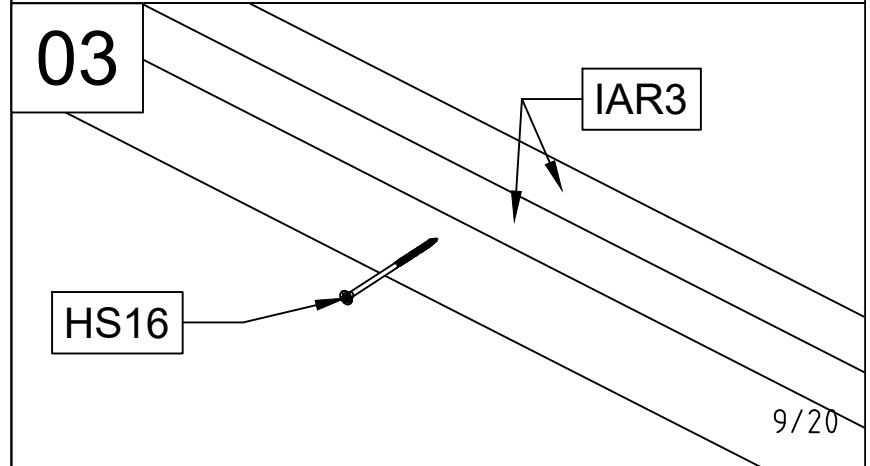
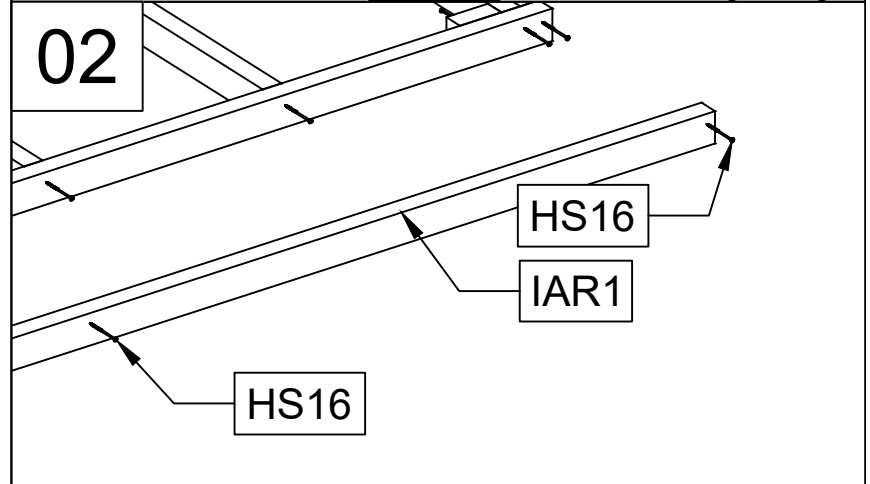
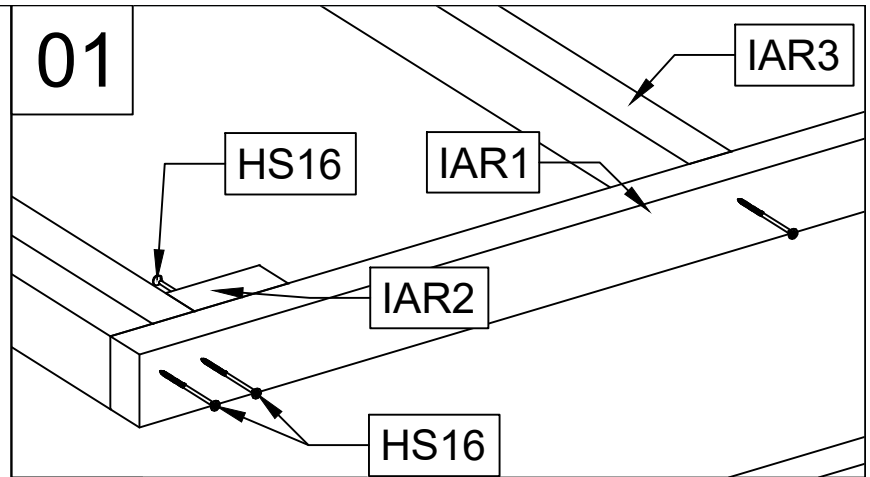
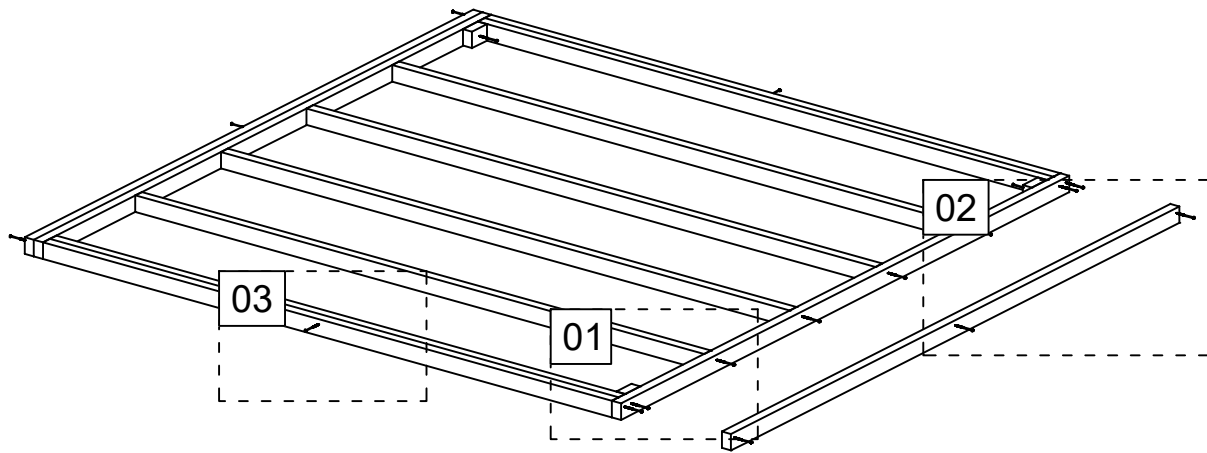

Art.Nr. WC165562

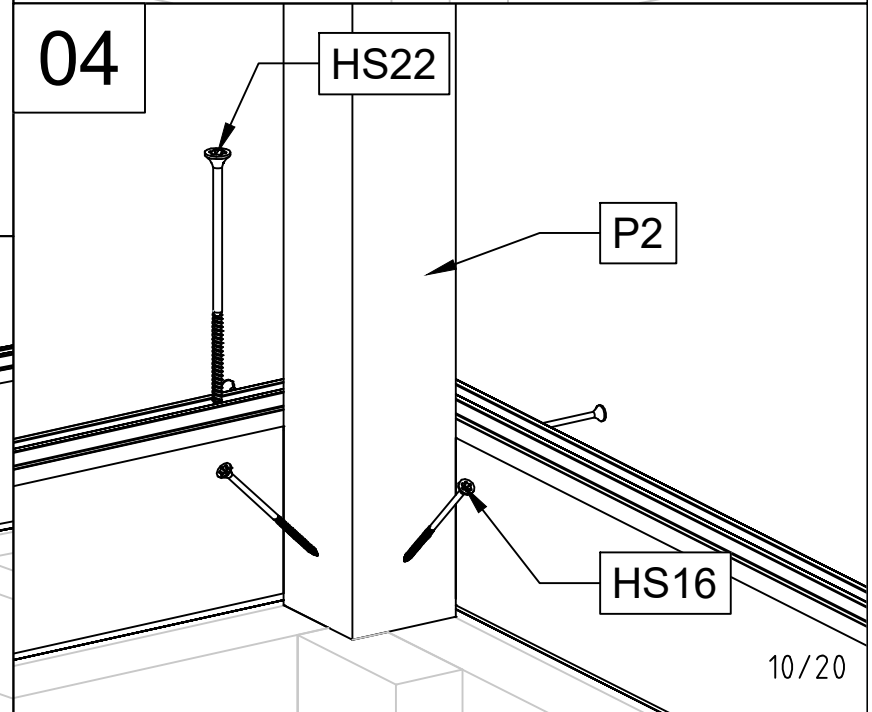
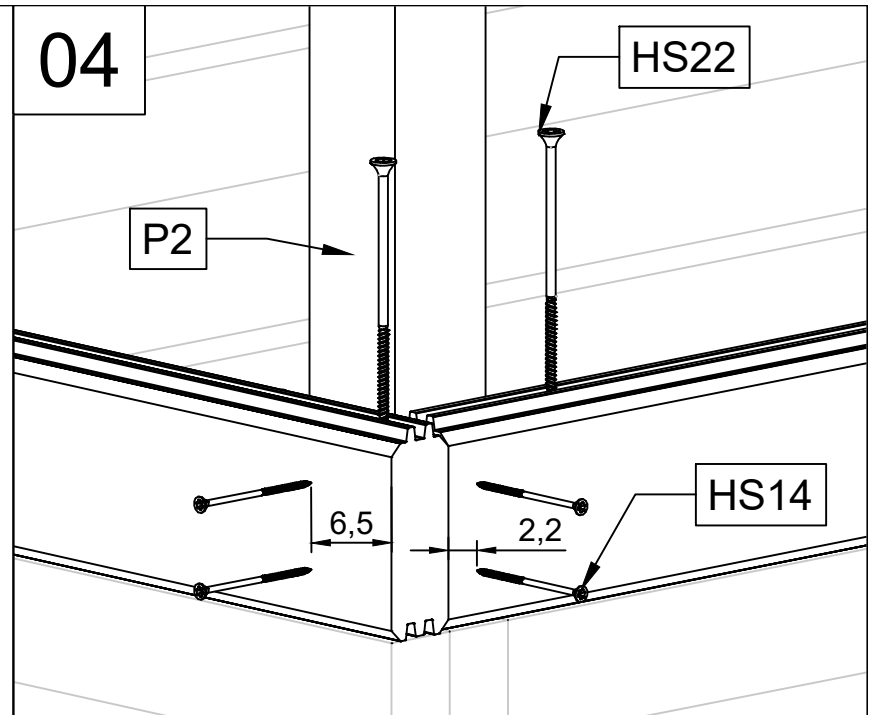
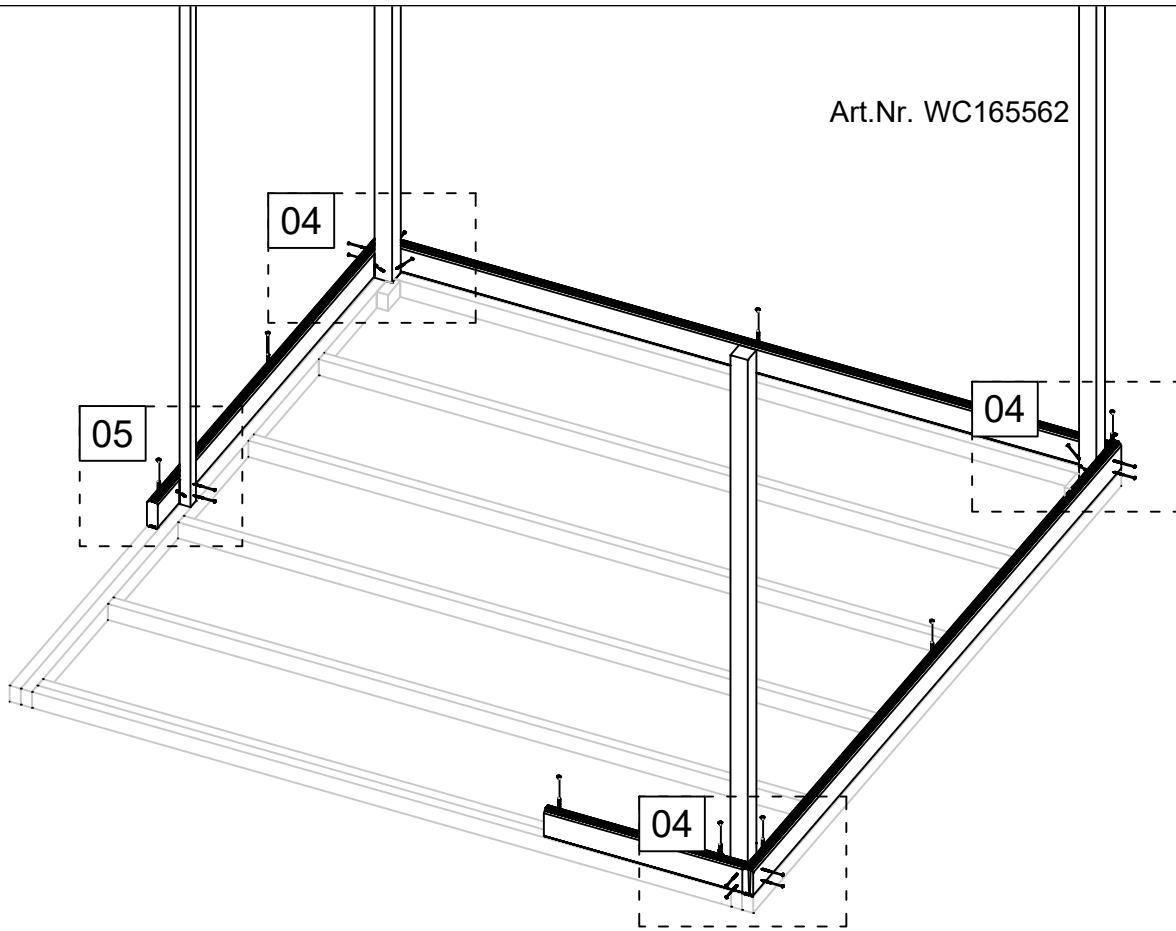

05

HS22

P1

HS14

HS16

10.10.2019

10/20

Art.Nr. WC165562

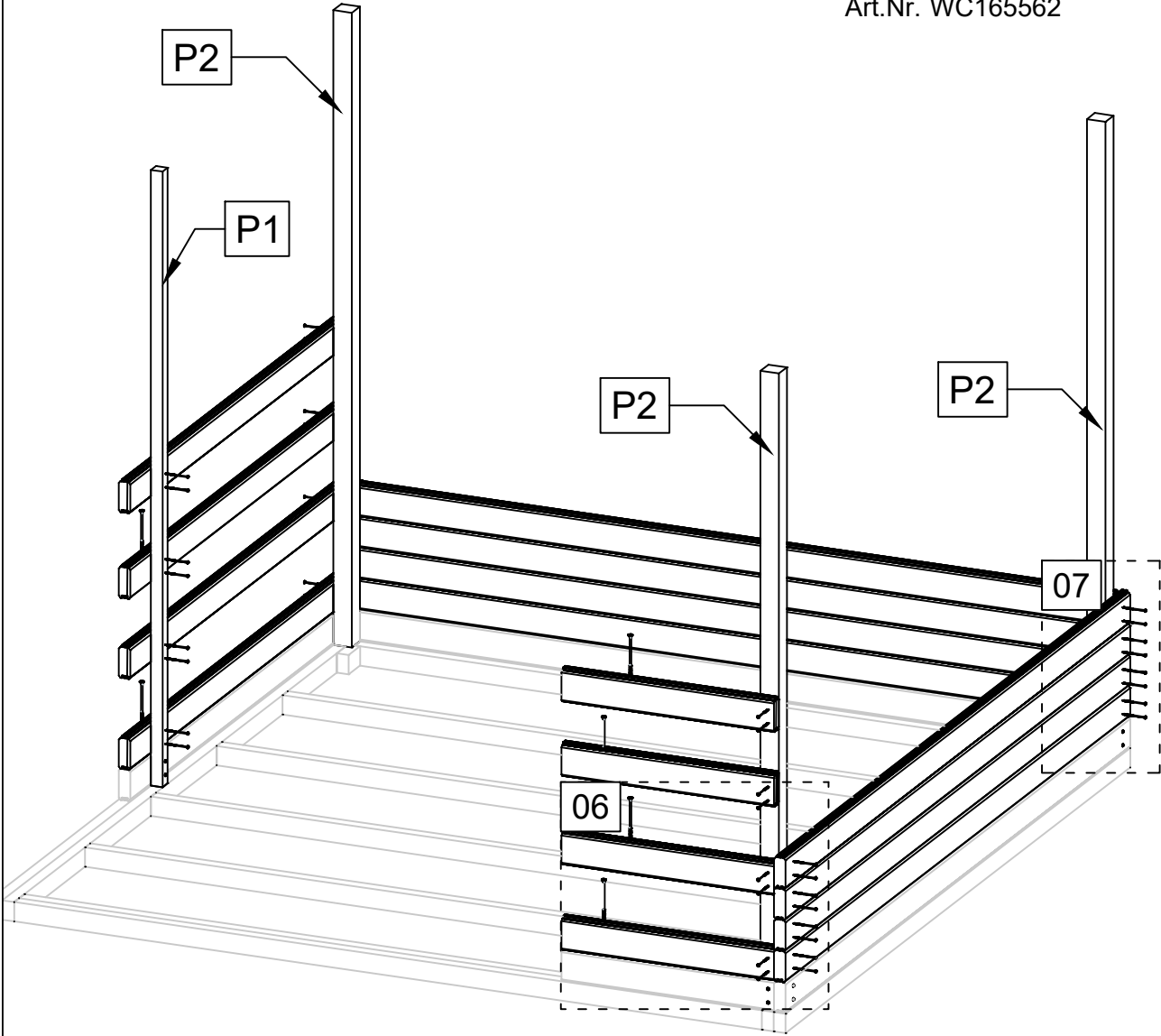

06

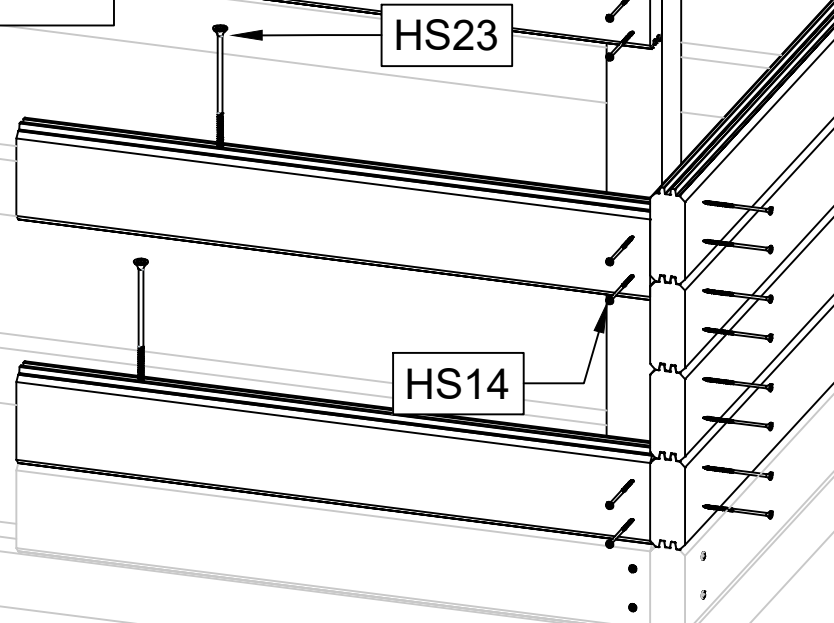

07

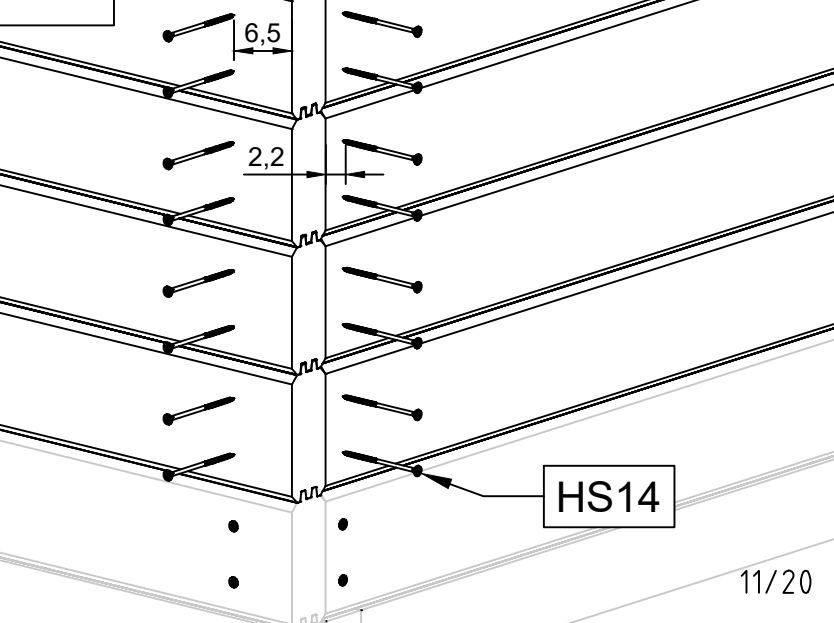

Art.Nr. WC165562

08

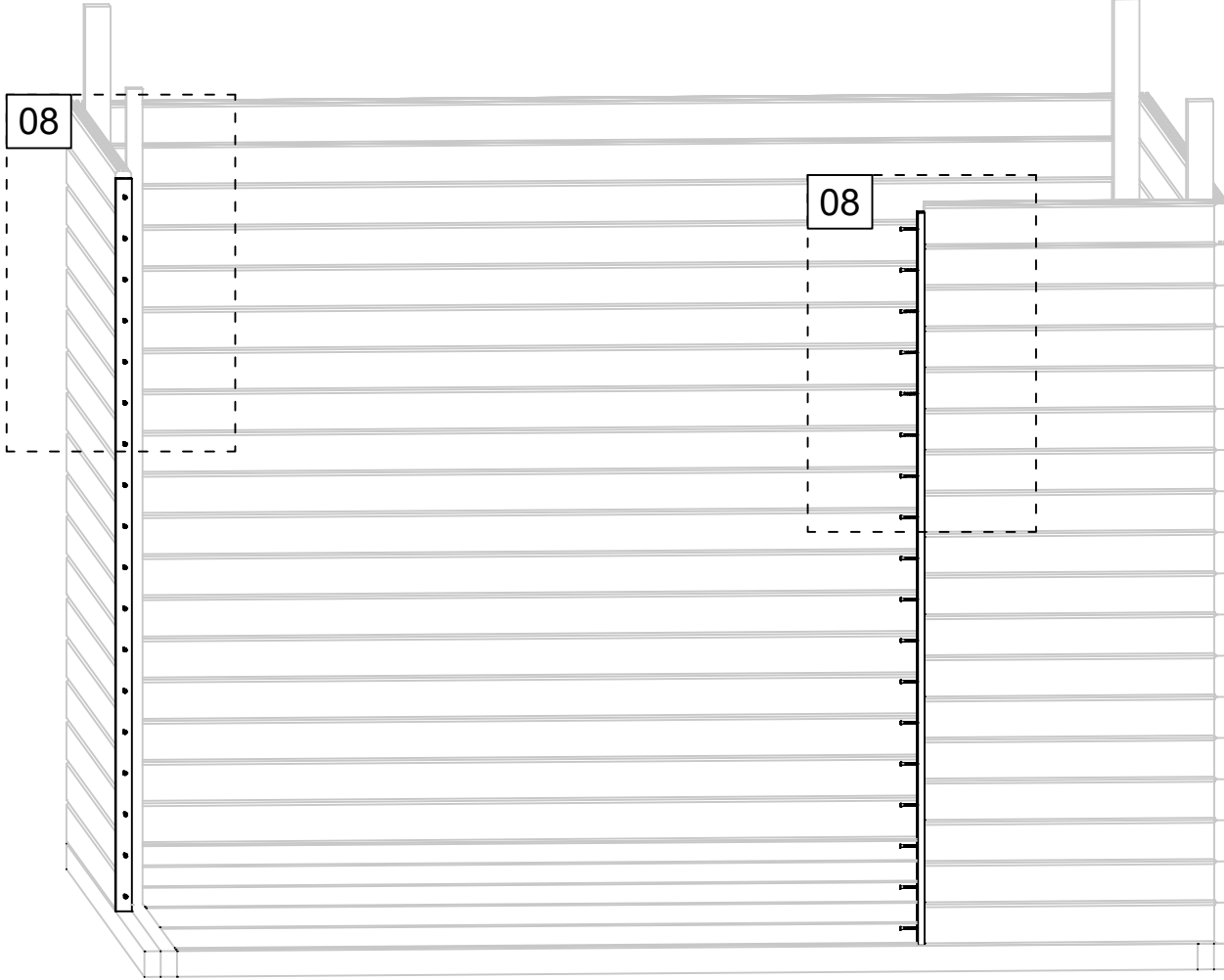

HS12

FF



Art.Nr. WC165562

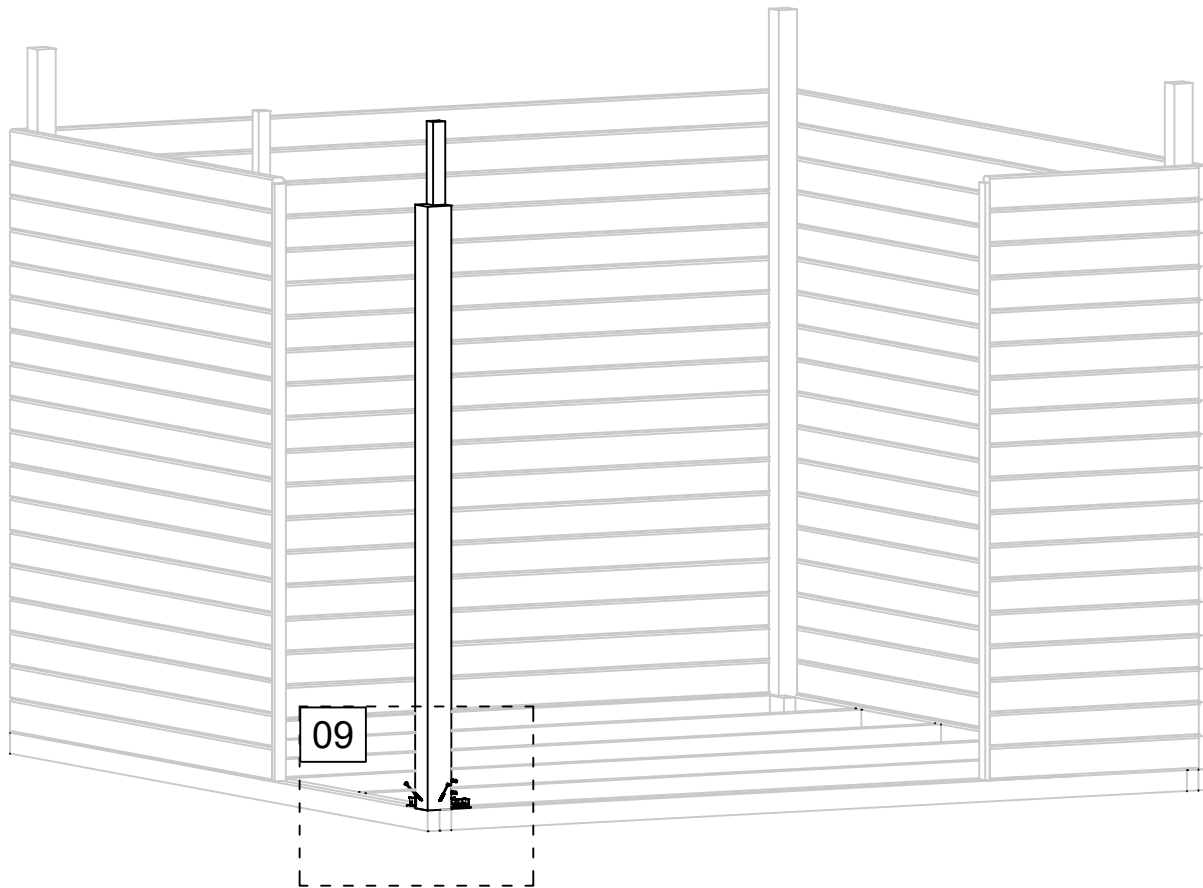

10.10.2019

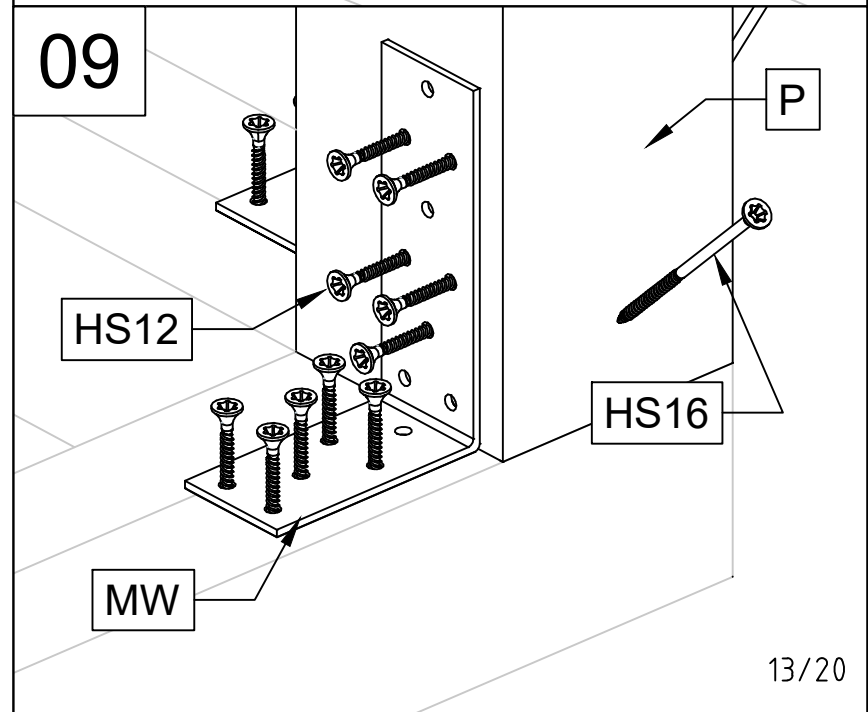
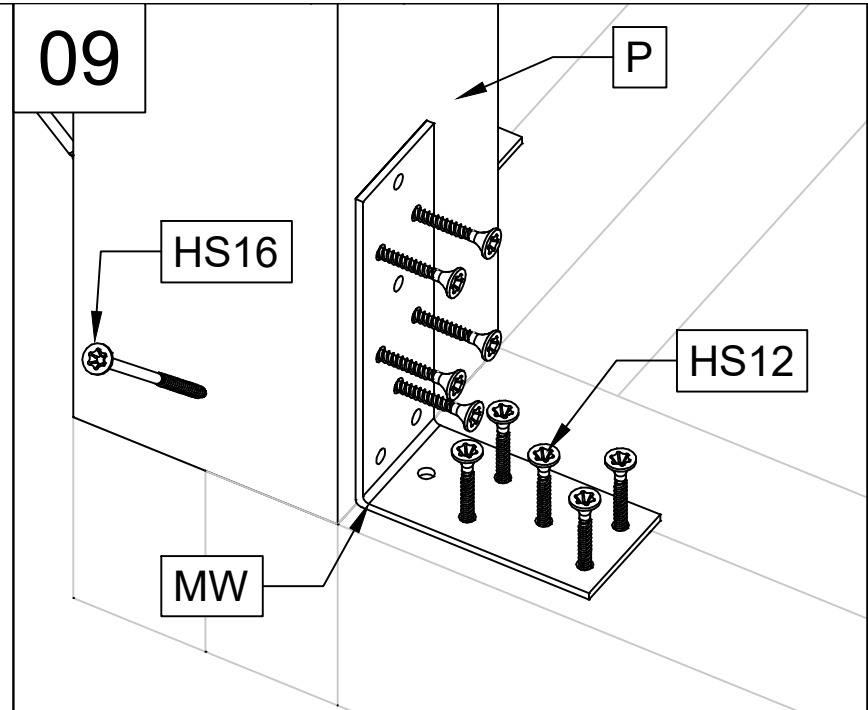

13/20

Art.Nr. WC165562

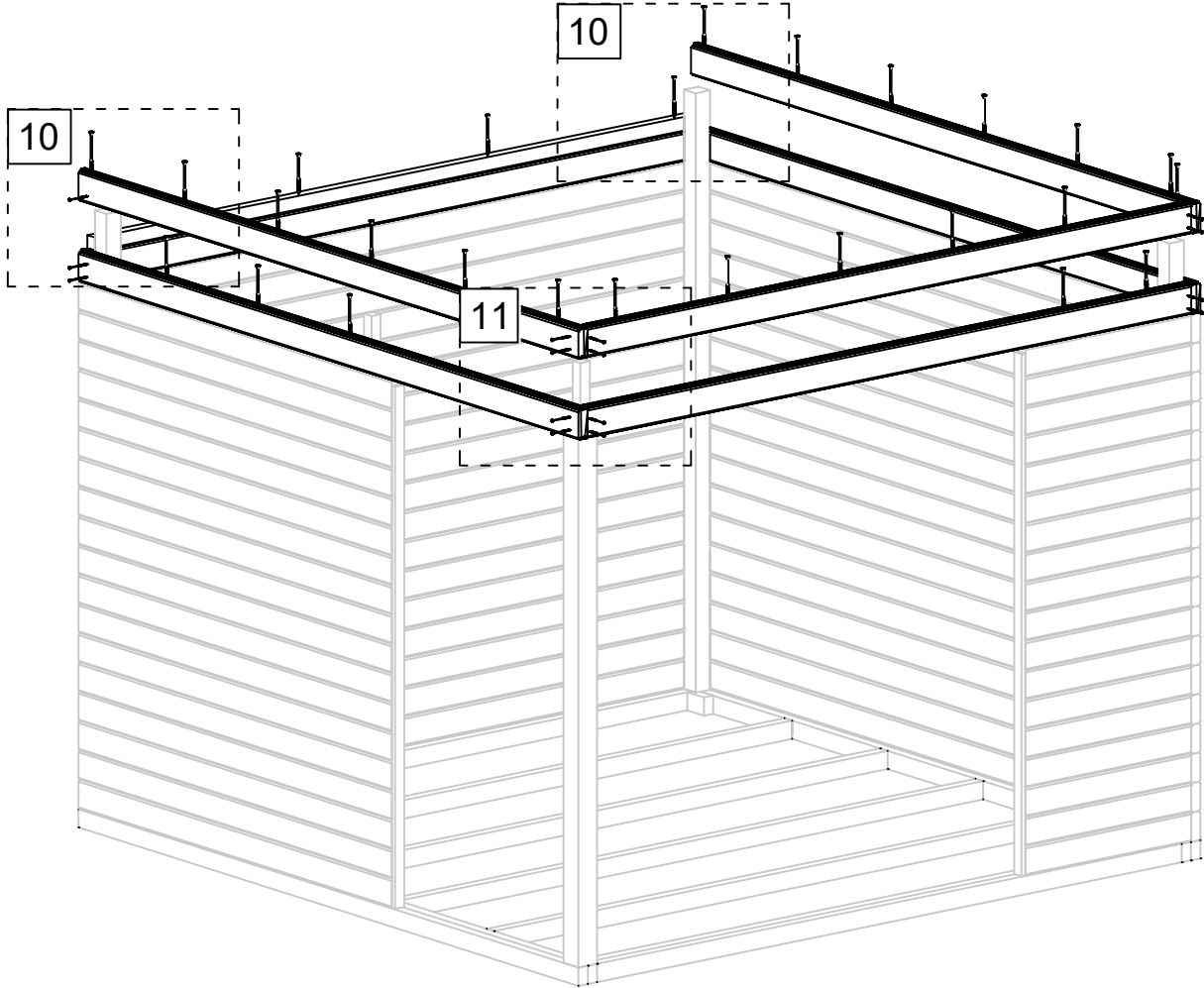

10

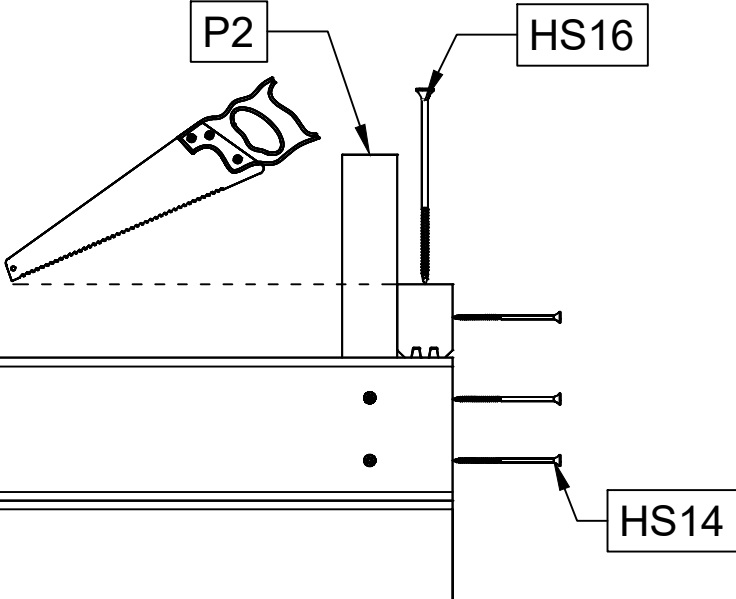

11

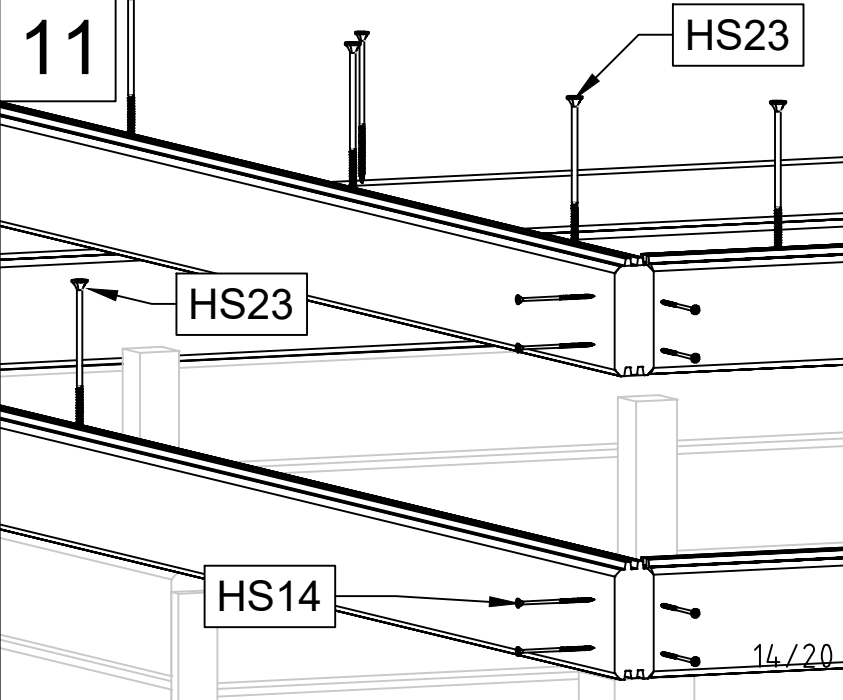

Art.Nr. WC165562

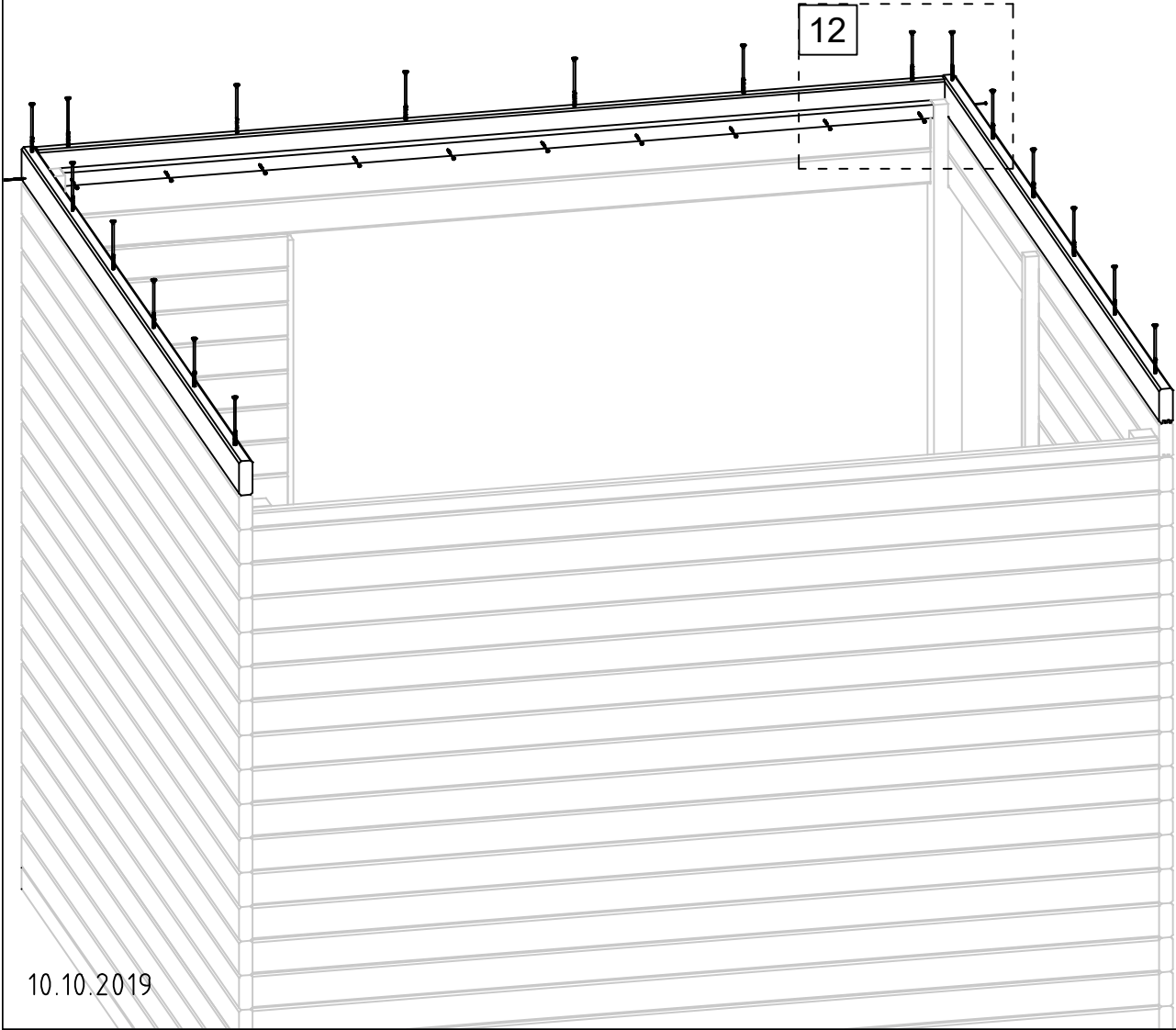

12

HS23

007

003

HS14

12

RV1

HS21

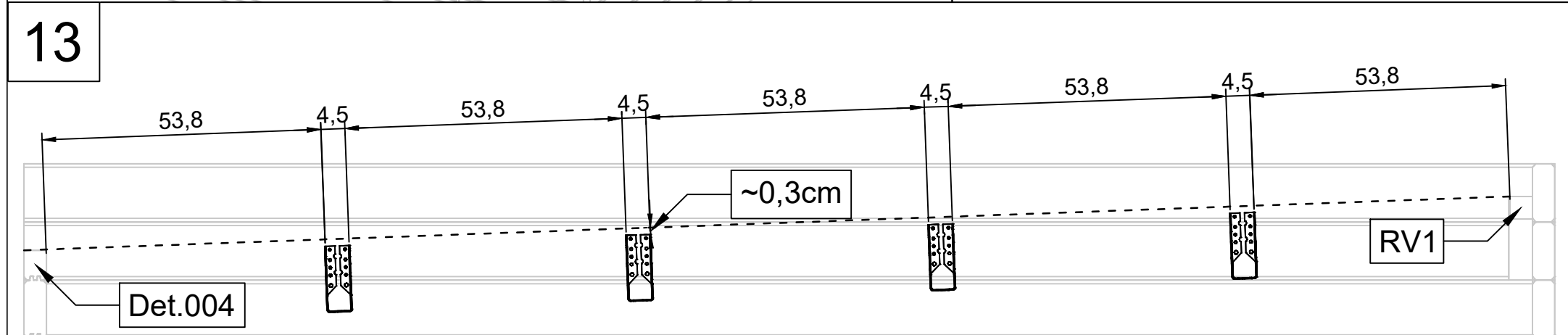
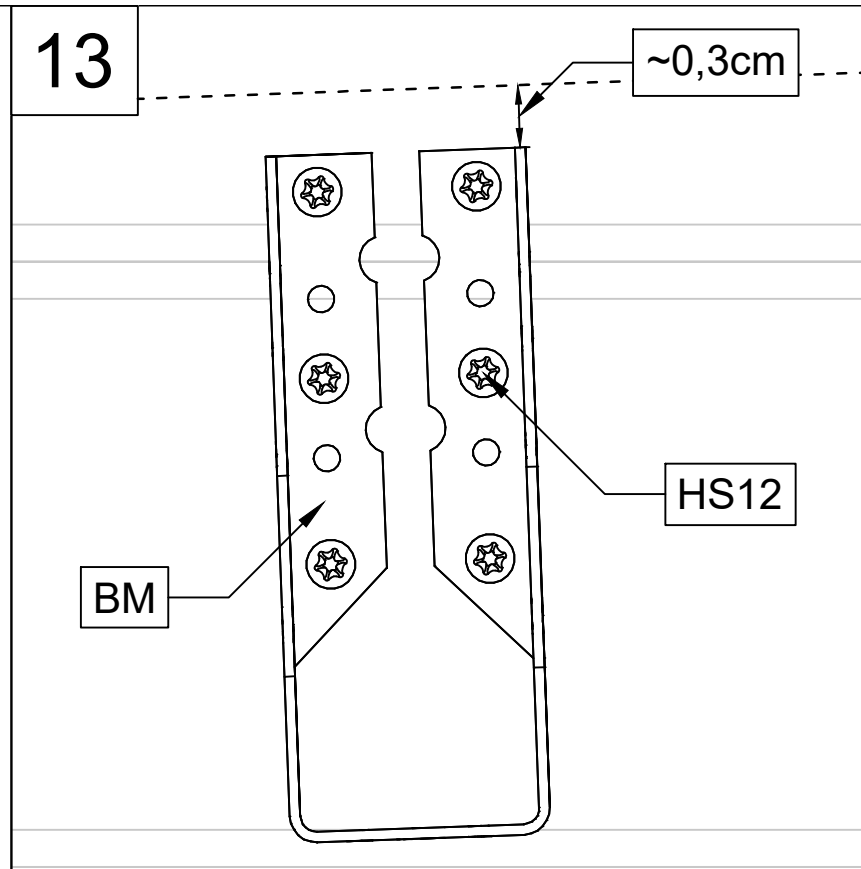
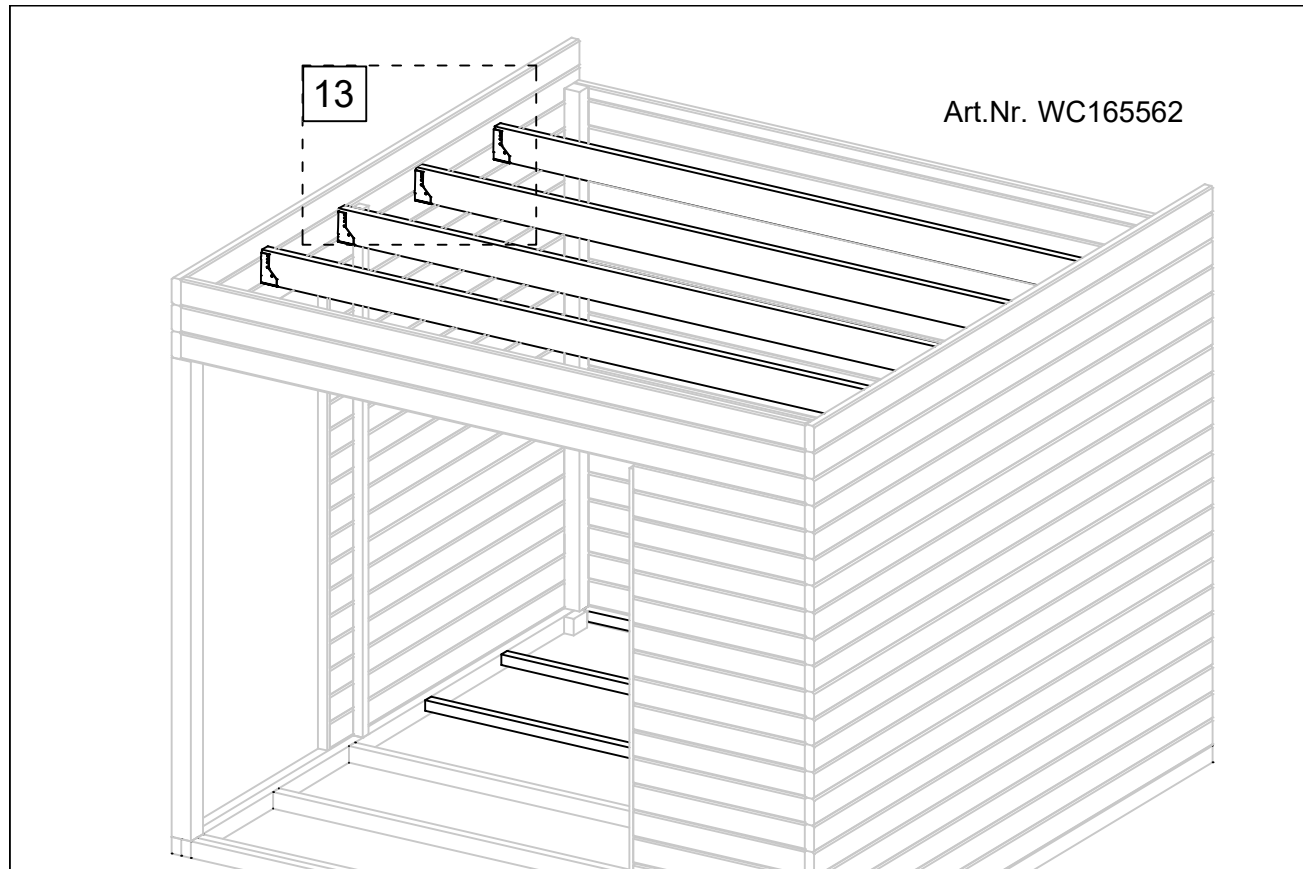

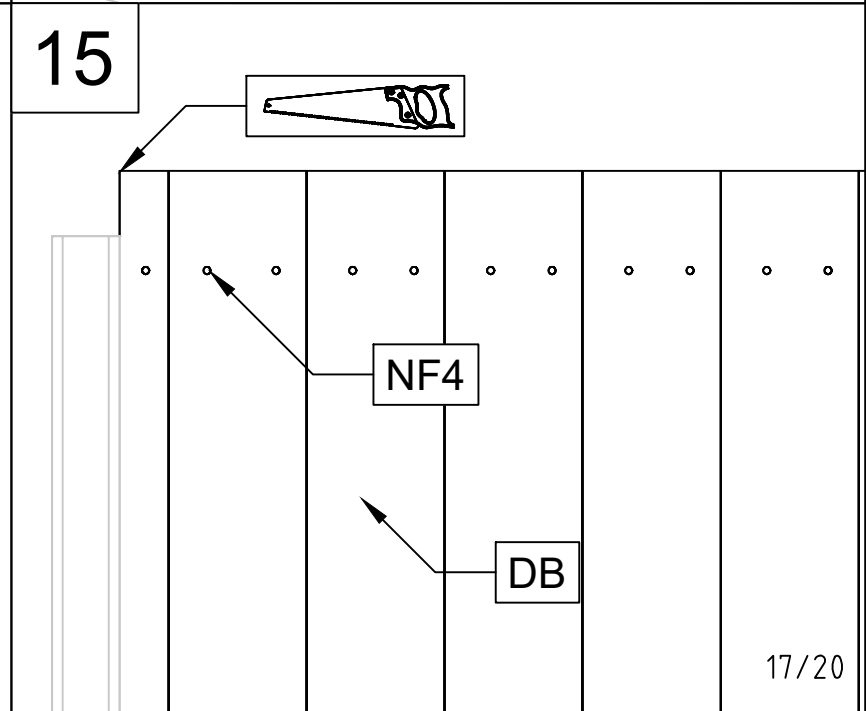
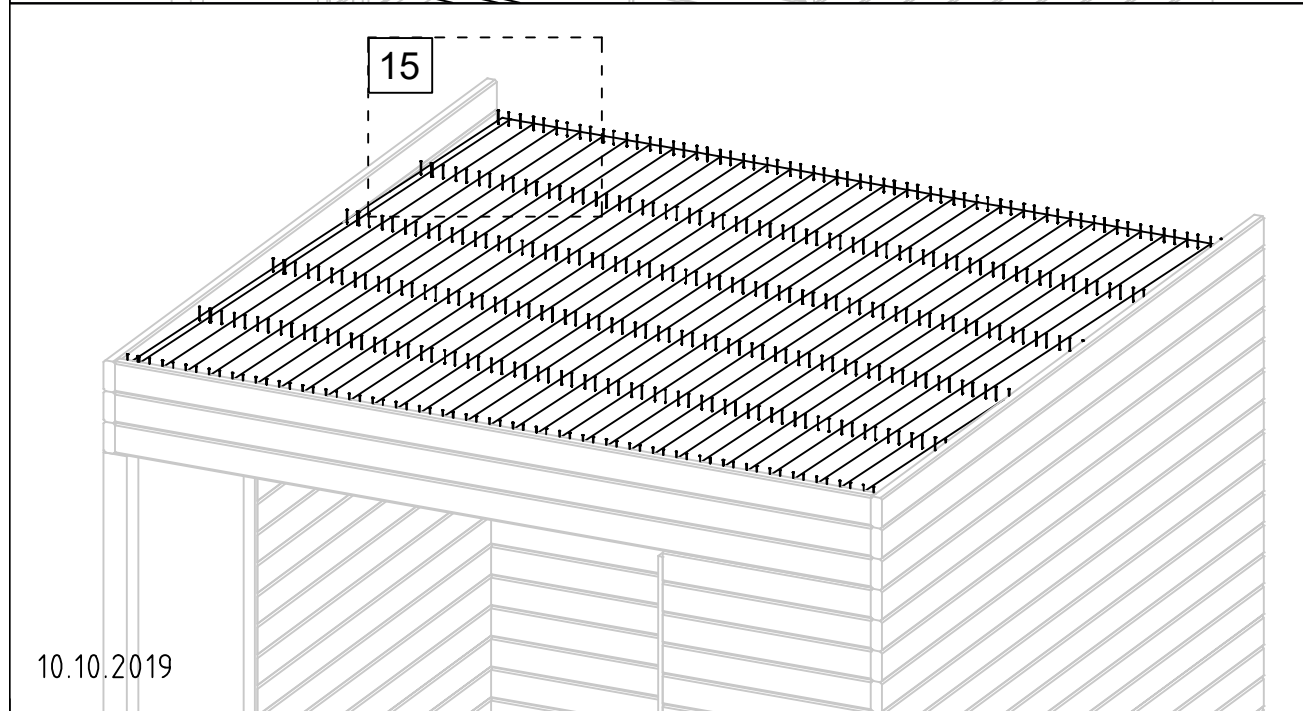
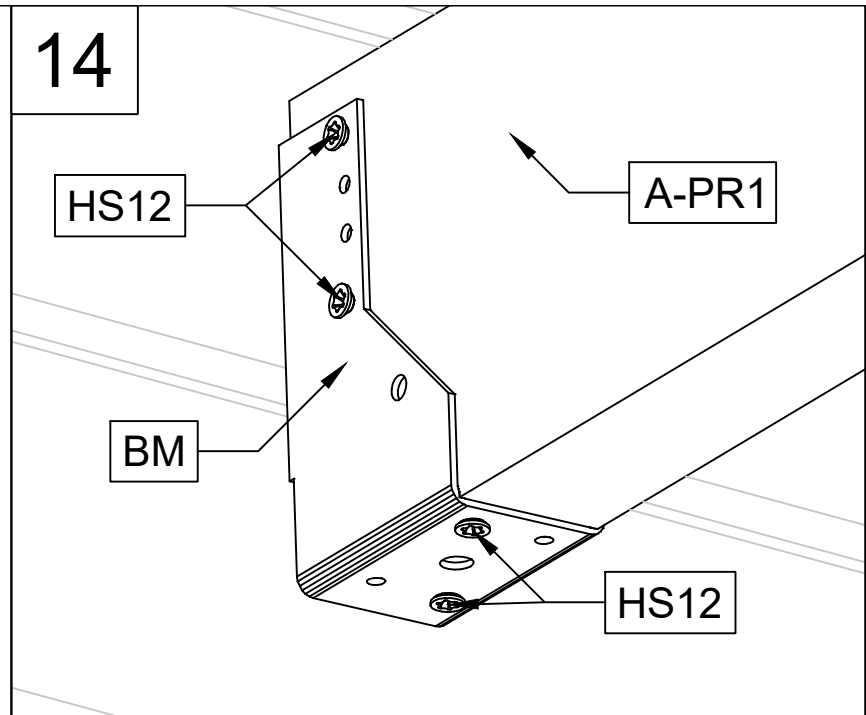
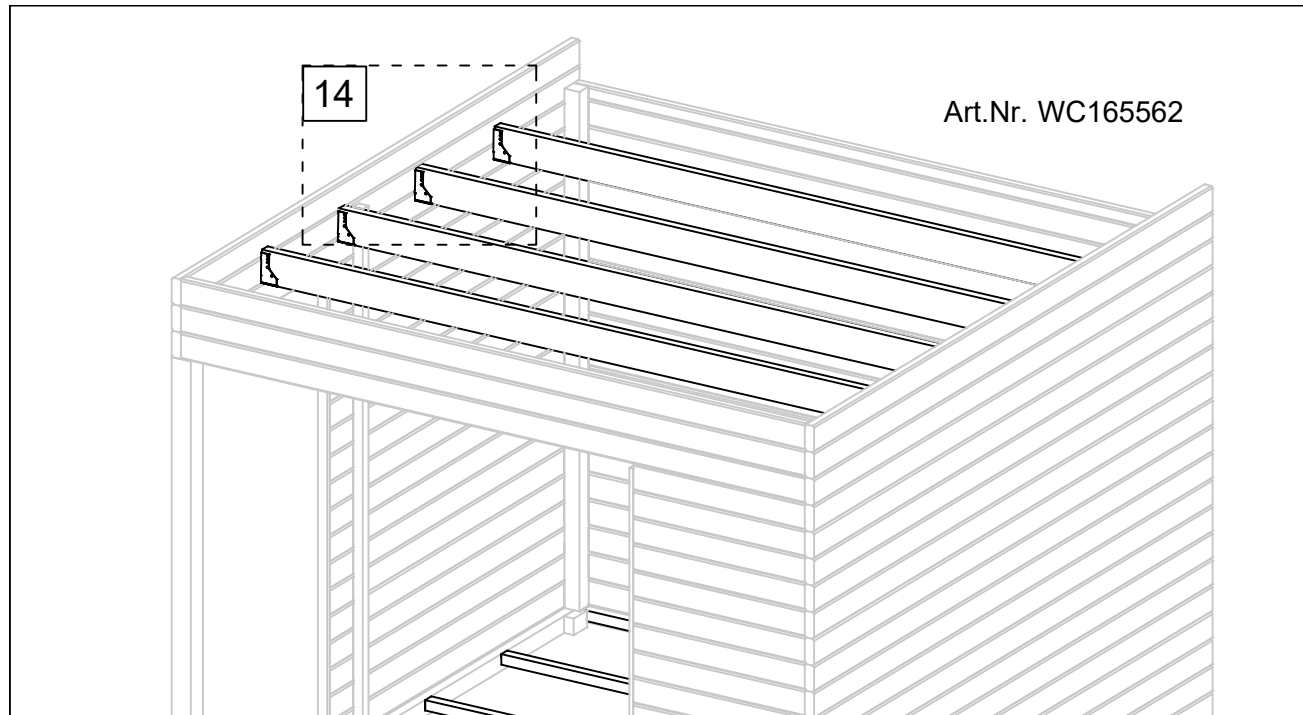

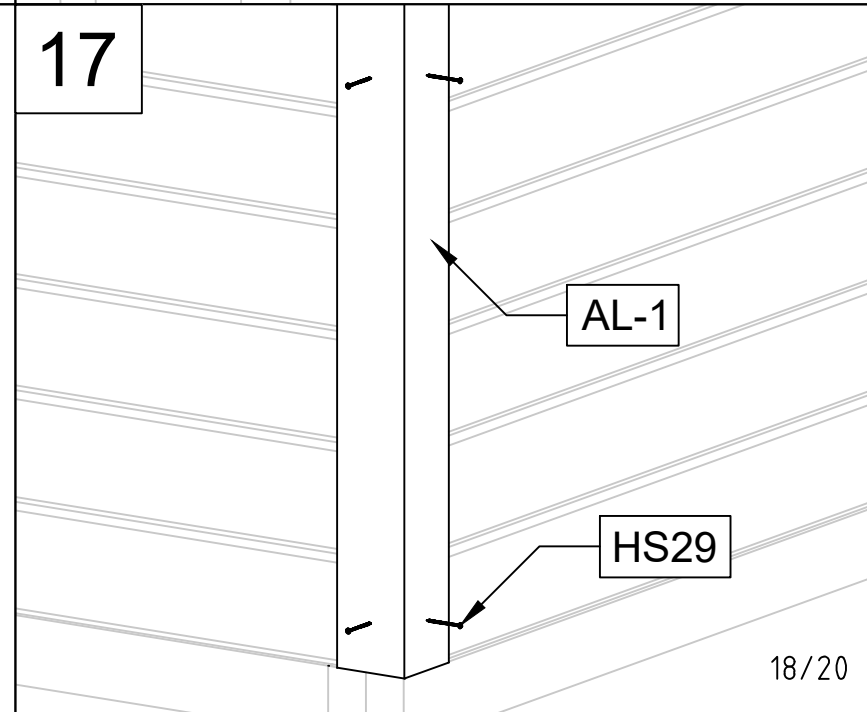
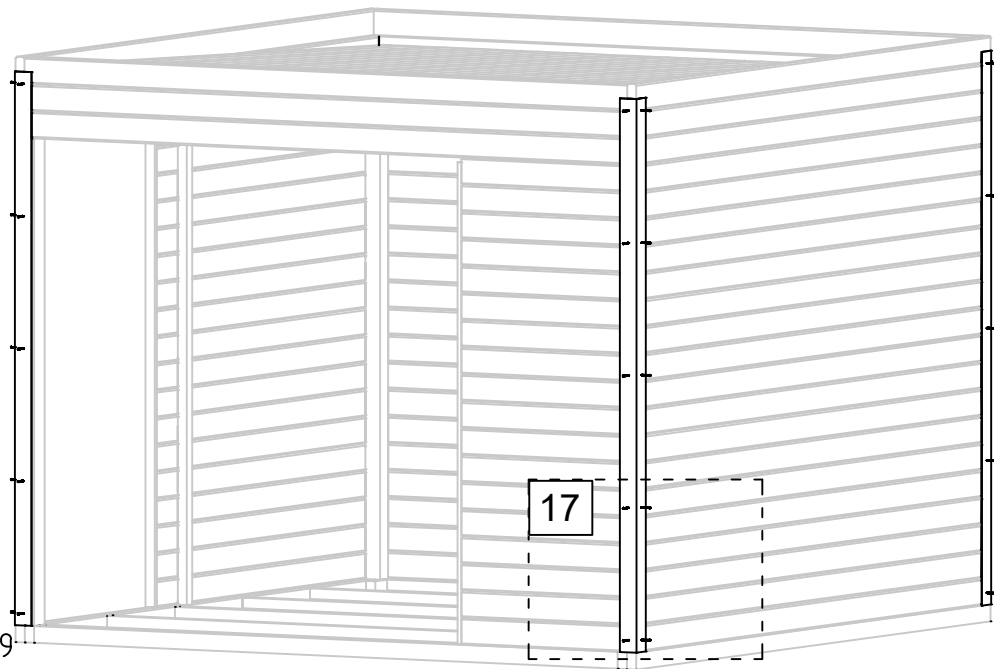
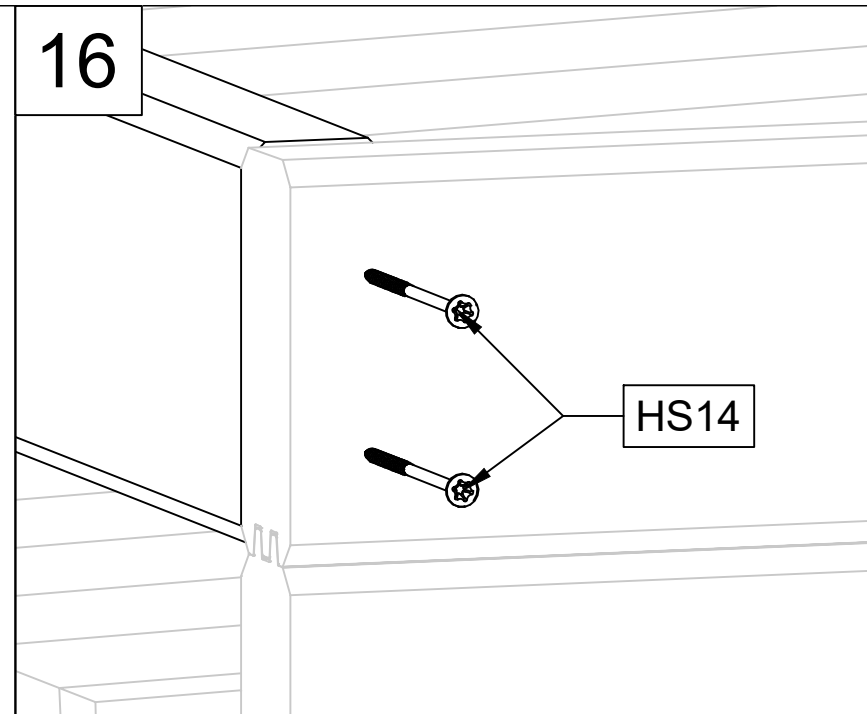
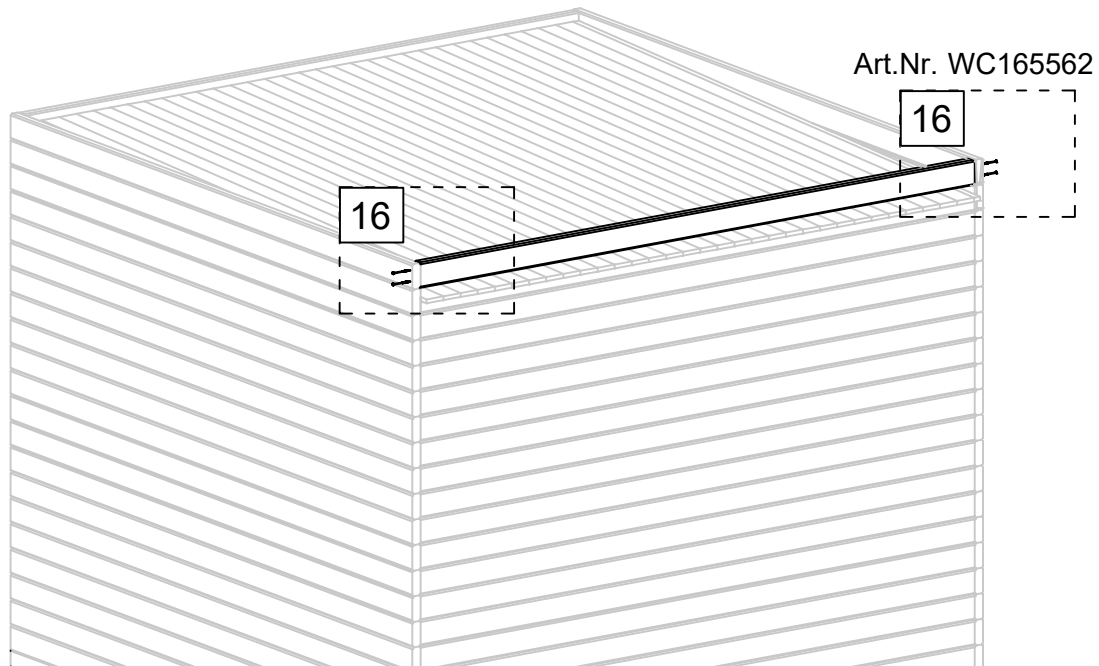

Art.Nr. WC165562

20

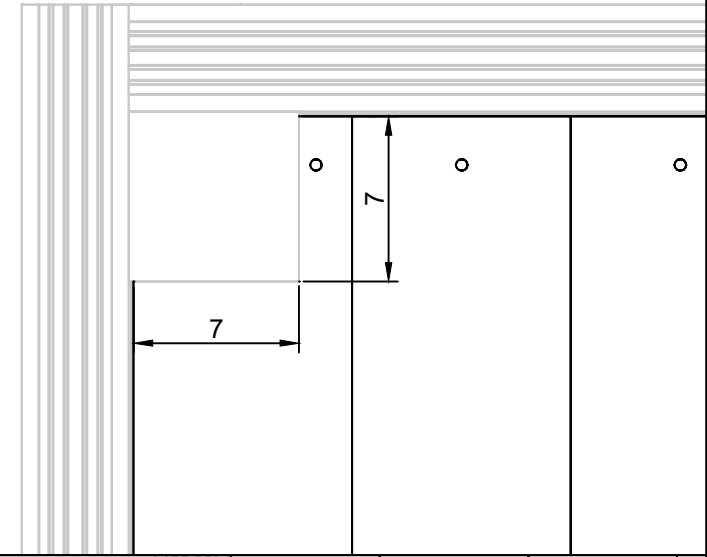

19

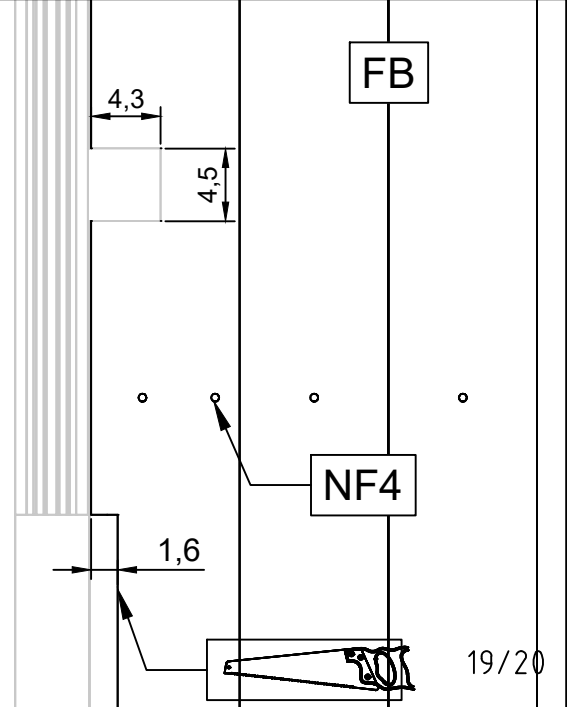

18

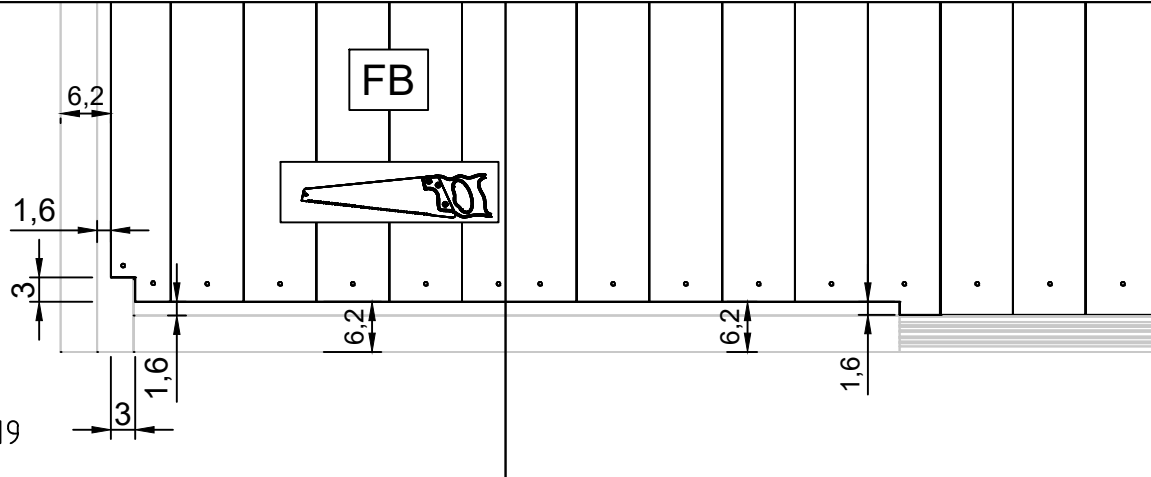

10.10.2019

19/20

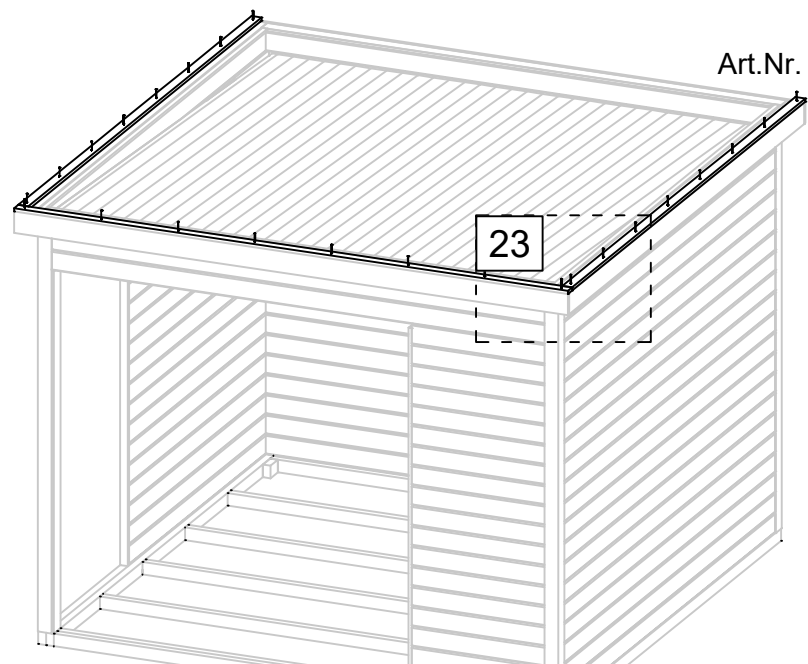

Art.Nr. WC165562

20

