

# MODULARO™

## WOODEN CABIN FLORENCE

3.9 x 3.97 x 2.45 m

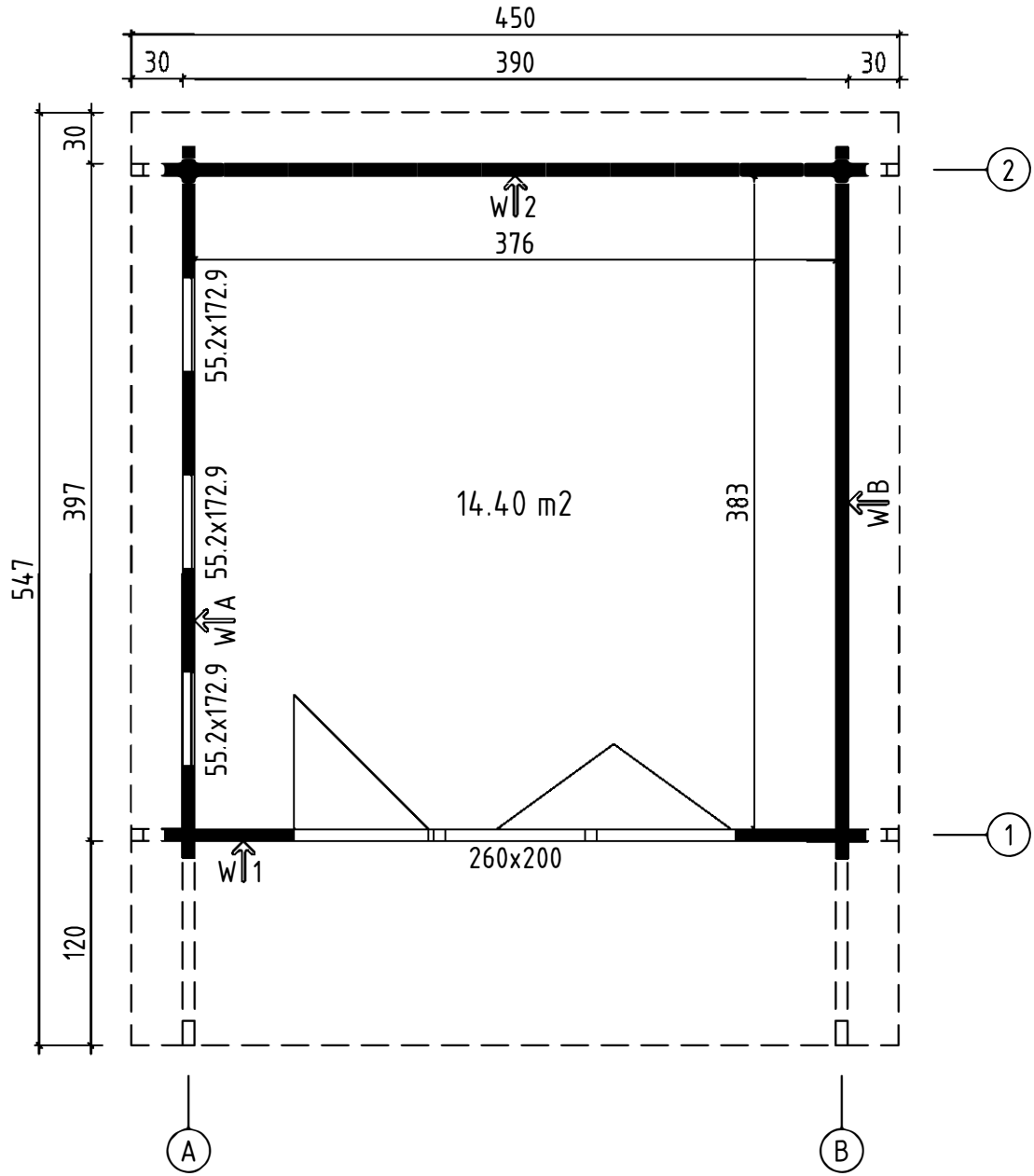





Art.Nr. WC165541

Rafters plan - Dachsparren - Plan de chevron - Piano di travi - Dak spar constructie  
plattegrond - Sarikaplaan

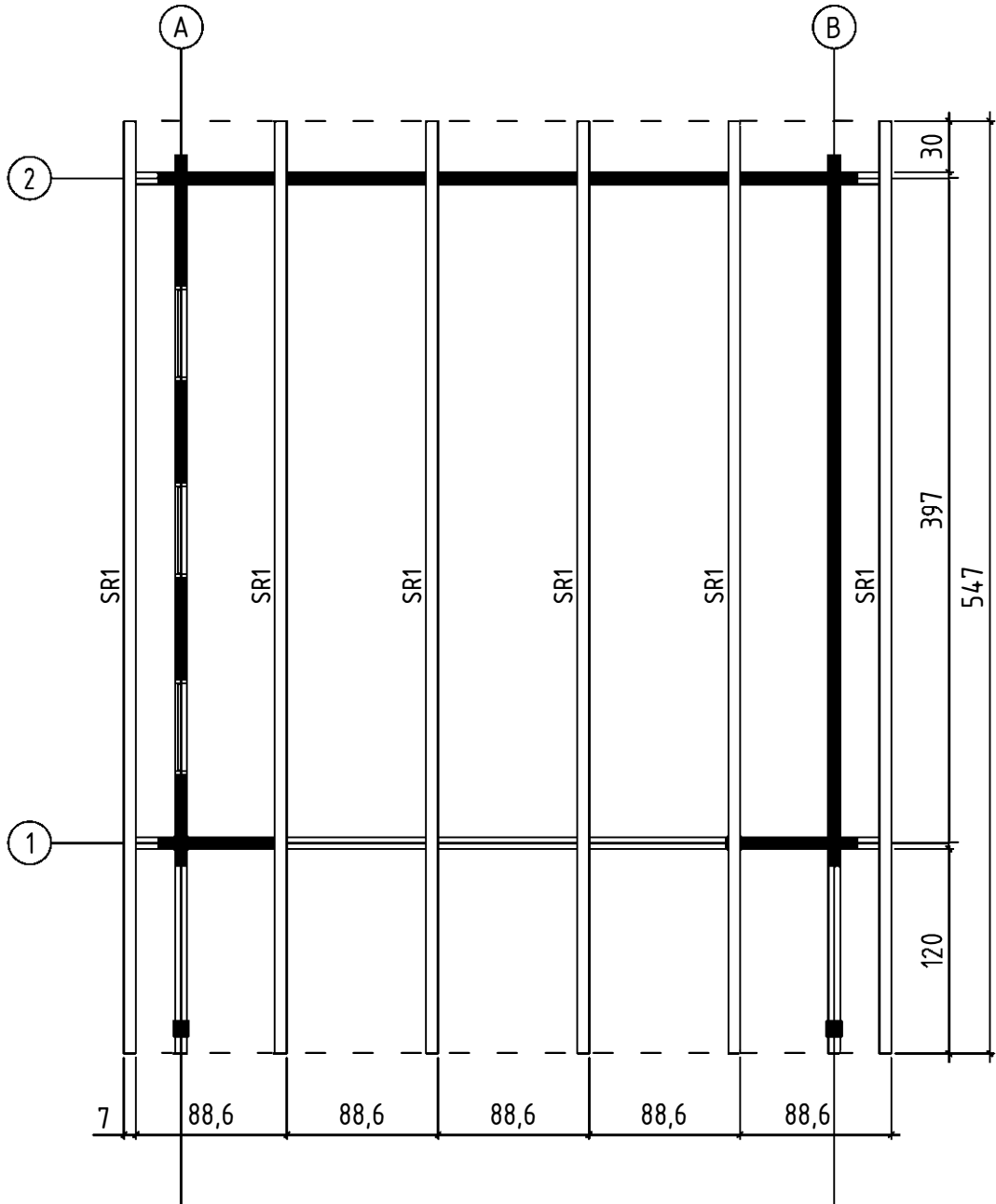

Art.Nr. WC165541

Floor boards - Fussbodenbretter - Plan pose plancher - Pavimento - Vloerhout -  
Põrandalaudis

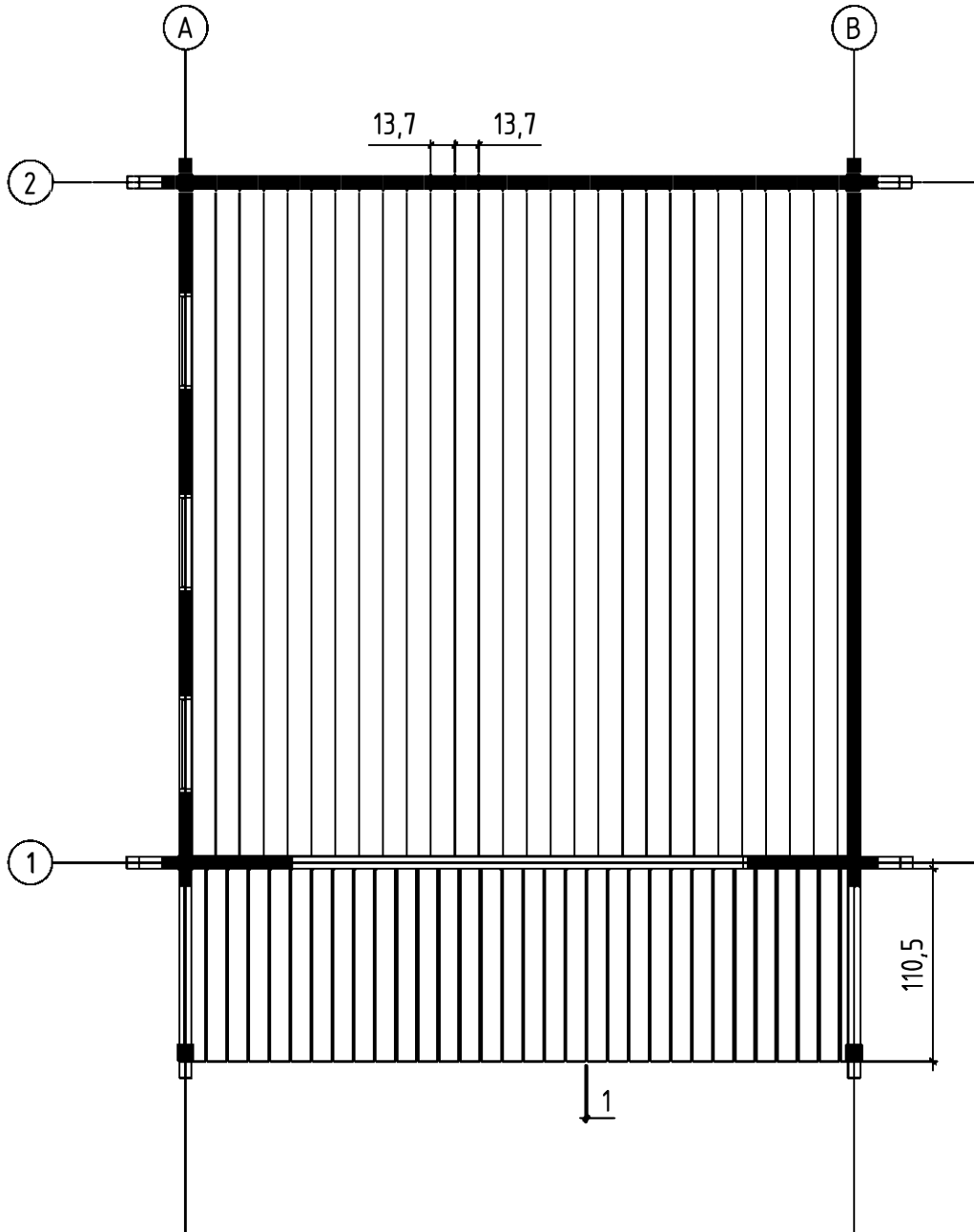

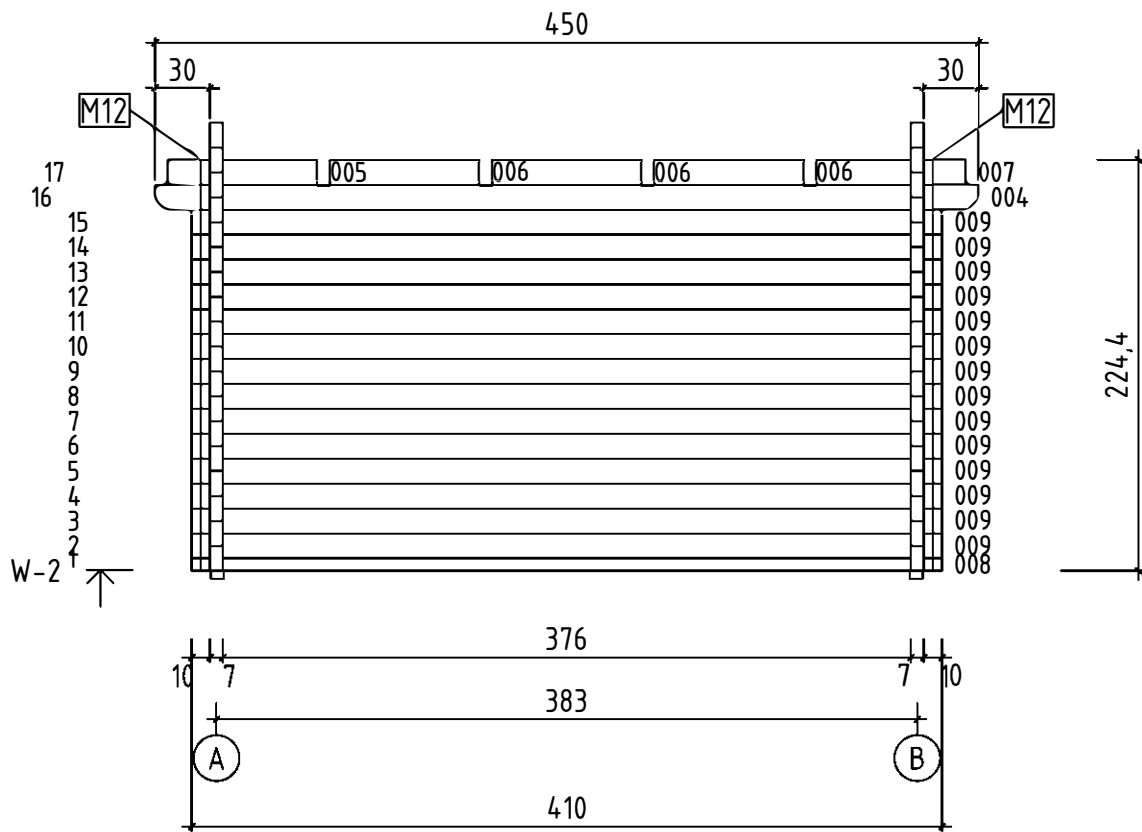
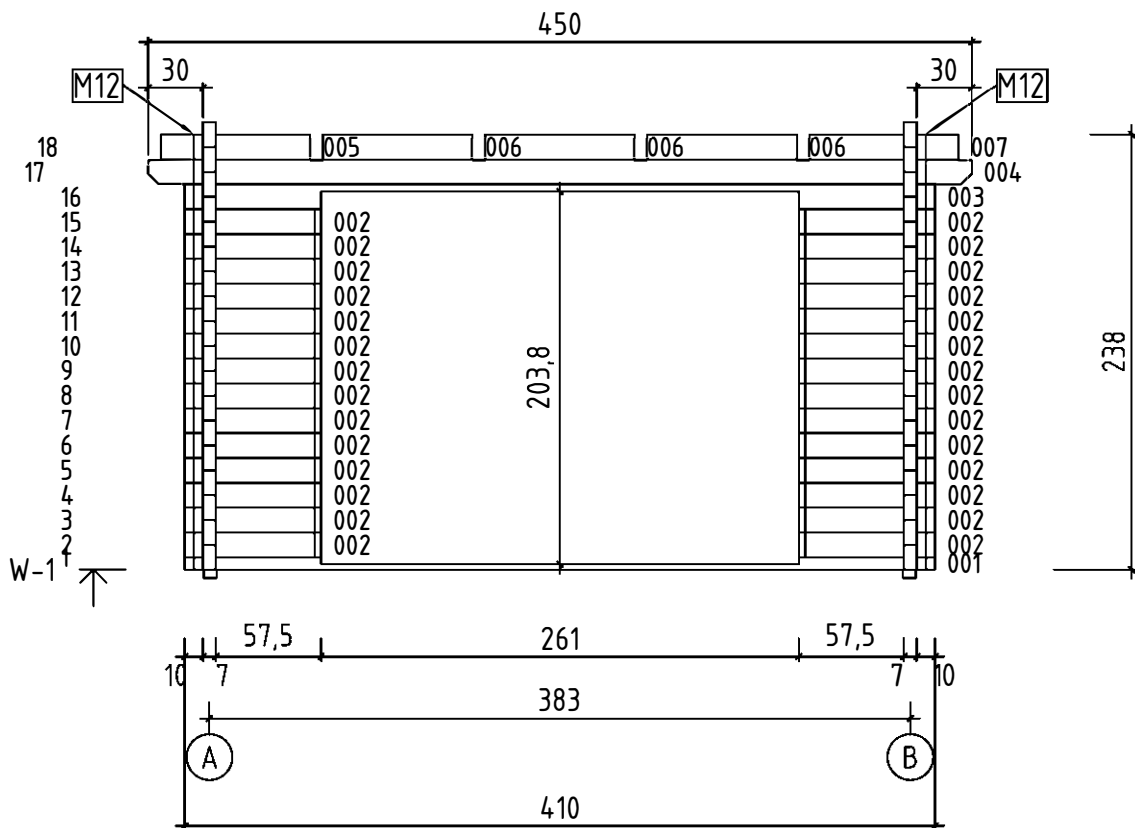

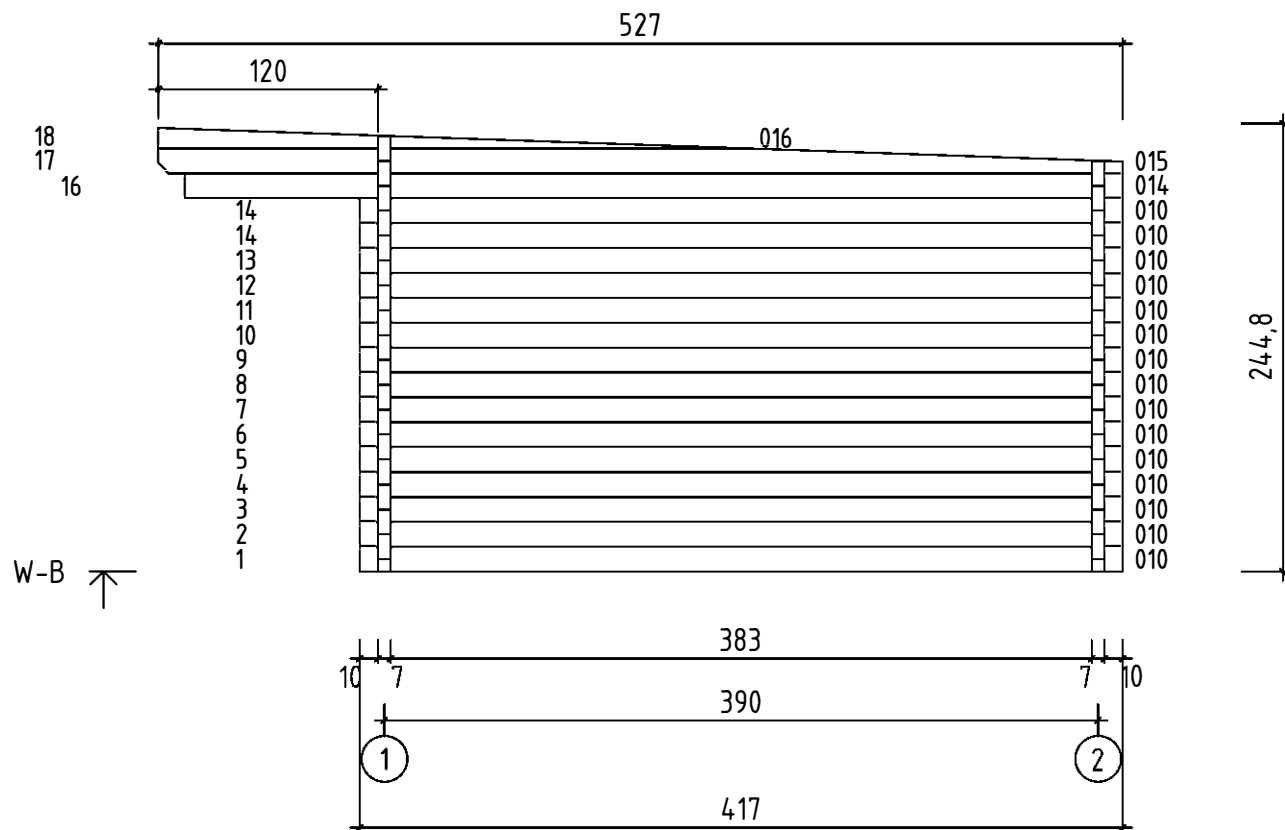
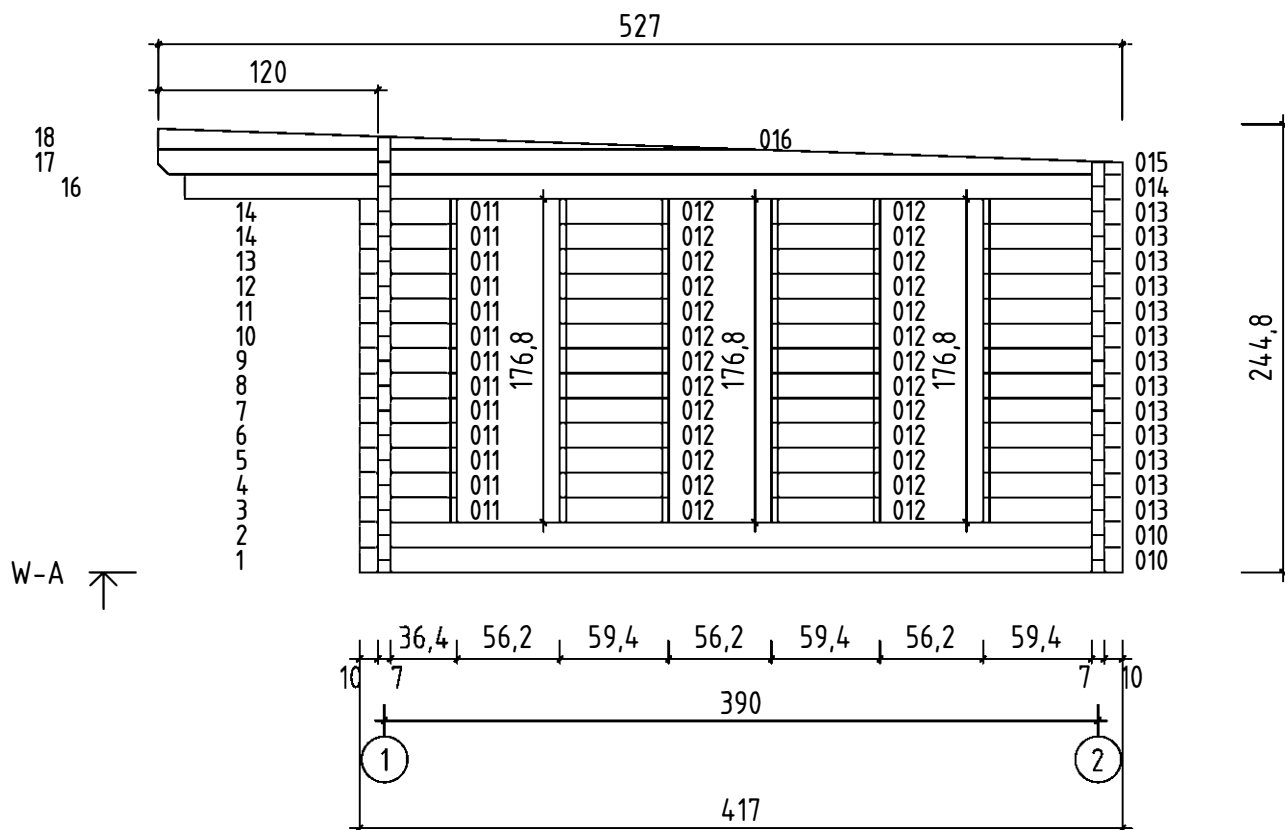

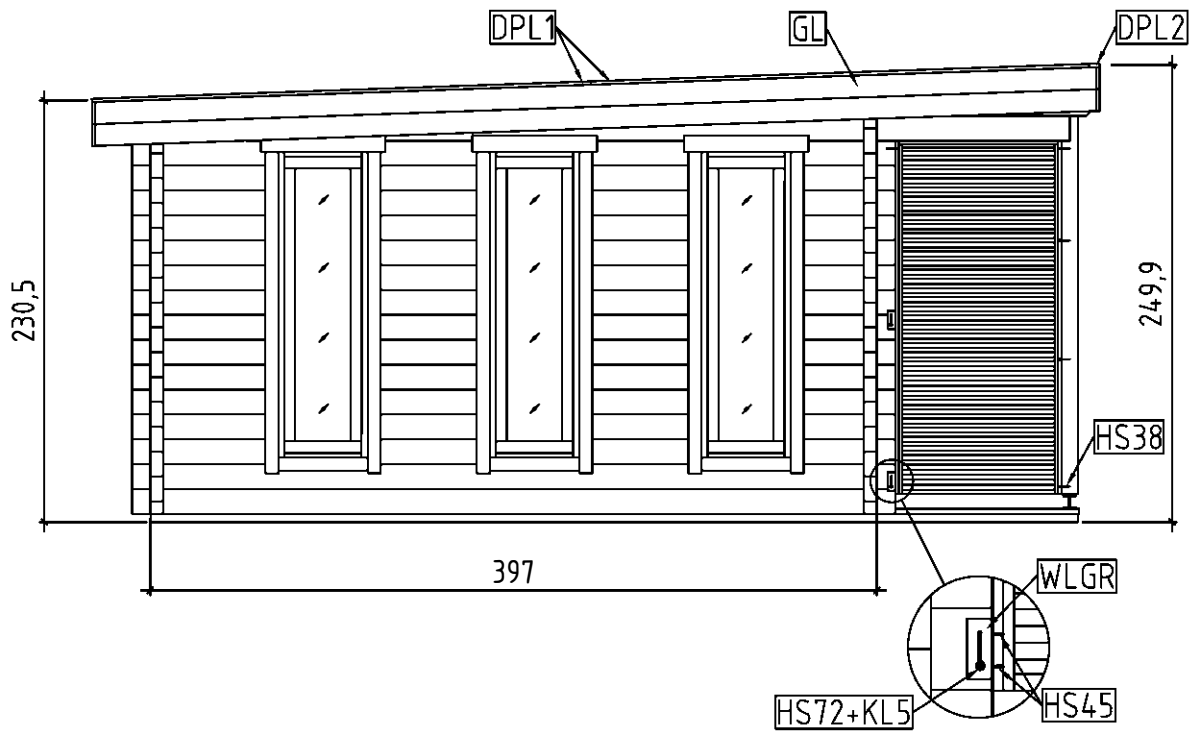
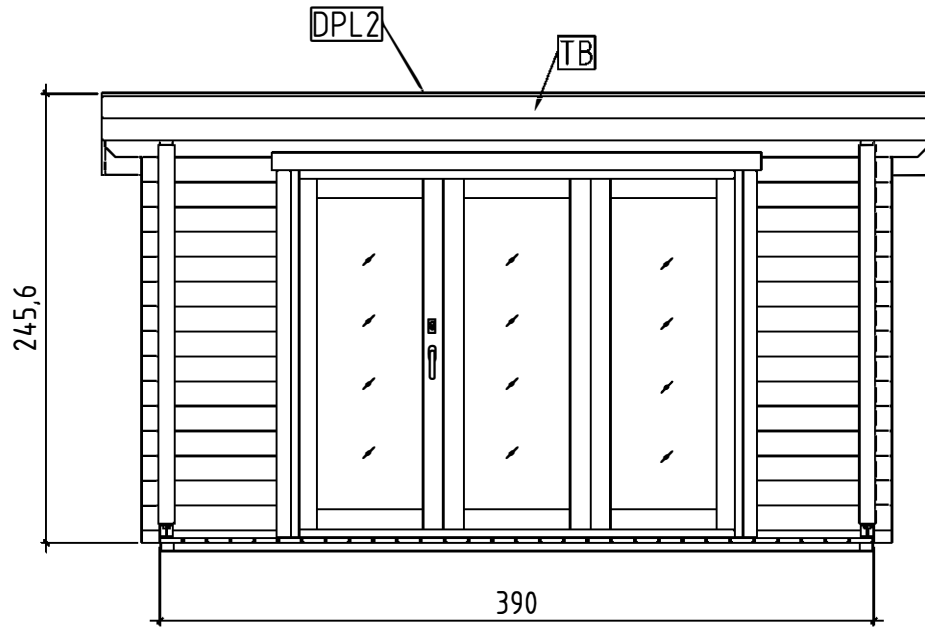



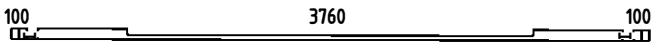
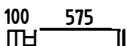
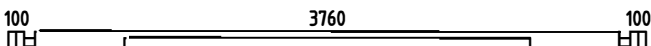
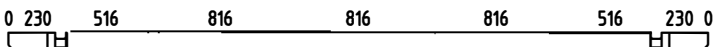
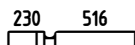
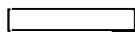
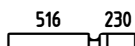
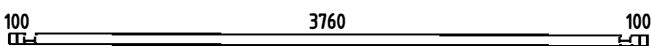
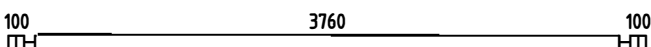
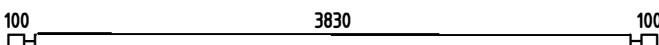

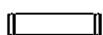
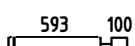
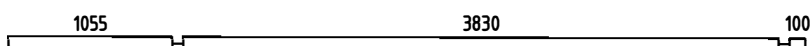
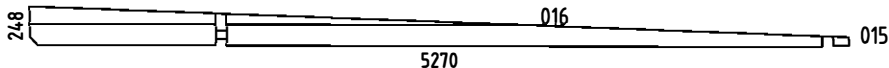
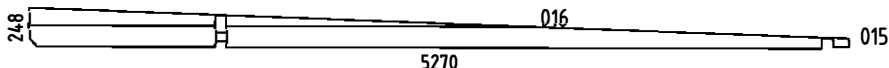

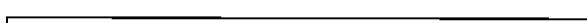
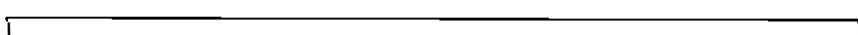





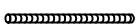
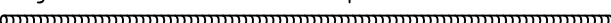
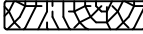

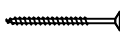
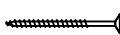
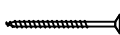
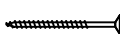

Pos	Art.Nr. WC165541 Piece list - Stückliste - Liste des pièces - Elementi - Stuklijst - Tükítabel	9/14	Q	P (mm)	L (mm)
001			1	70x68	4100
002			28	70x136	745
003			1	70x136	4100
004			2	70x136	4500
005			2	70x136	816
006			6	70x136	816
007			2	70x136	816
008			1	70x68	4100
009			14	70x136	4100
010			17	70x136	4170
011			13	70x136	534
012			26	70x136	594
013			13	70x136	763
014			2	70x136	5125
WA-1			1		
WB-1			1		
IAR1	Foundation - Fundament - Fondation - Fondamenta - Fundering - Immutatud alusraam 		2	70x45	5065
IAR2	Foundation - Fundament - Fondation - Fondamenta - Fundering - Immutatud alusraam 		12	70x45	3750
SR1	Rafter - Dachsparren - Chevron - Trave - Dak spar - Sarikas 		6	70x140	5478
HLL	Floor boards - Fussbodenbretter - Lame de plancher - Pavimento - Vloerhout - Põrandalaud 			137x28	112.48
RB	Roof boards - Dachbretter - Voliges - Perlina per tetto - Dakhout - Katuselaud 		61	90x18	4500
SV2	Terrace boards - Terrassenbretter - Plancher de terrasse - Piattaforme terrazzo - Terrasvloer - Terrasilaud 		30	120x28	1105
FL	Floor fillet - Fussbodenleiste - Corniere de finition du plancher - Finitura per pavimento (battisco pa) - Vloerafwerkljst - Põrandaliist 			15x40	16

Pos	Art.Nr. WC165541 Piece list - Stückliste - Liste des pièces - Elementi - Stuklijst - Tükítabel	10/14	Q	P (mm)	L (mm)
DPL1	Roofing felt fillet - Dachpappenleiste - Baguette de fixation du feutre bitumeux - Asse per fissaggio guaina bituminosa - Afdekljst asfaltpapier - Katusepapiiist 		4	18x58	2726
DPL2	Roofing felt fillet - Dachpappenleiste - Baguette de fixation du feutre bitumeux - Asse per fissaggio guaina bituminosa - Afdekljst asfaltpapier - Katusepapiiist 		1	18x58	4538
M12	Treaded rod m12 - Gewindestange m12 - Tige filetée m12 - Barra filettata passo m12 - Draadstang 12m - Keermelatt 		2		270
M12	Treaded rod m12 - Gewindestange m12 - Tige filetée m12 - Barra filettata passo m12 - Draadstang 12m - Keermelatt 		2		410
M12	Treaded rod m12 - Gewindestange m12 - Tige filetée m12 - Barra filettata passo m12 - Draadstang 12m - Keermelatt 		4		2000
P	Post - Pfosten - Poteau - Piede registrabile - Stijl - Post 		2	90x90	2070
TB	Fascia board - Traufbrett - Bandeau de toit - Finitura lati tetto - Gevellijst - Räästalaud 		4	18x120	4538
TBE6	Fixing fillet - Fixierungsleiste - Profil de fixation - Massello di fissaggio - Bevestiging lijstwerk - Tenderlijst 		6	28x34	1729
TBE6	Fixing fillet - Fixierungsleiste - Profil de fixation - Massello di fissaggio - Bevestiging lijstwerk - Tenderlijst 		2	28x34	1836
GL	Gable moulding - Giebelleiste - Planche de rive - Finitura per frontale e retro del tetto - Gevellijst - Viilulaud 		4	18x120	5478
KL4	Lengthening bolt for treaded rod - Verlängerungsmutter für gewindestange - Manchon de raccordement de tige filetée - Bullone per barra filettata passo - Extensie moer voor draadstang - Jätkumutter keermelatile 		4		
KL1	Drive nut treaded rod - Ein Schlagmutter für gewindestange - Écrou a frapper pour tige filetée - Dado guida per barra filettata - Aandrijfmoer / aanslagmoer voor draadstang - Löökmutter keermelatile 		4		
KL2	Nut for treaded rod - Mutter für gewindestange - Écrou pour tige filetée - Dado per barra filettata - Moer voor draadstang - Mutter keermelatile 		4		
KL3	Plain washer treaded rod - Unterlegscheibe für gewindestange - Rondelle plate pour tige filetée - Rondella per barra filettata - Sluistring voor draadeind - Seib keermelatile 		4		
HS25	Screw for floor - Schrauben für fussbodenbretter - Vis pour plancher - Viti per le pertine del pavimento - Schroef voor vloerhout - Krugi põrandale 		250	3.5x50	
HS32	Screw for fascia boards - Schrauben für traufbretter - Vis pour fixation bandeau de toit - Viti x striscia del tetto - Schroef voor gevellijst - Krugi räästalaualae 		56	3.5x50	
HS84	Screw for fixing fillet of door and window - Schrauben für fixierungsleiste - Vis pour profil vertical de fixation pour ouvertures des fenetres et portes - Viti per massello di fissaggio - Schroeven voor bevestiging van deur en raam lijsten - Krugi tenderlijstudele 		40	3.5x50	
HS16	Screw for gable moulding - Schrauben für giebelleiste - Vis pour fixation planche de rive - Vite per fissare finiture davanti e dietro del tetto - Schroef voor gevellijst - Krugi viilulauale 		56	3.5x50	
HS38	Screw for fixing terrace railing - Schraube für terrasse - Vis de fixation de garde-corps de terrasse - Vite per fissaggio della ringhiera al terrazzo - Schroef voor terras - Krugi piirdeaia kinnituseks 		10	4.5x80	
HS45	Screw for sliding wall tie - Schieberegler für wand - Sabot métallique pour fixation mur - Vite per fissare scorrimento a c su slitta fissata alla parete - Schuifdeur instellingen wand - Krugi seinaliugurite 		16	4x20	
NFD	Screw for roofing felt fillet - Schrauben für dachpappenleiste - Vis pour fixation baguette de fixation feutre bitumeux - Vite per massellino del feltro del tetto - Schroef voor asfaltpapier afdekljst - Krugi katusepapiiistule 		34	4x40	
HS34	Screw for post - Schrauben für pfosten - Vis de fixation des poteaux - Viti per inviare - Schroef voor stijlen - Krugi postile 		4	4x60	
HS40	Screw for 1. wall beam - Schraube für 1. bohlenreihe - Vis de fixations 1ere rangée de madriers avec poutrelles de fondations - Vite fissaggio alle fondamenta - Schroef voor 1 wandbalk - Krugi poollauale 		6	5x120	

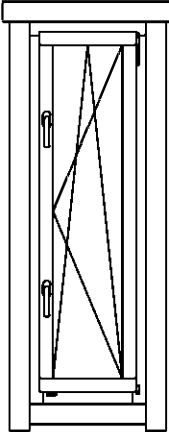
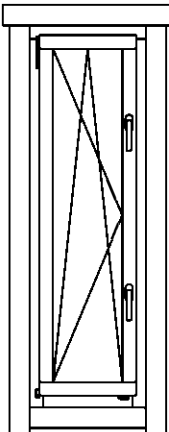
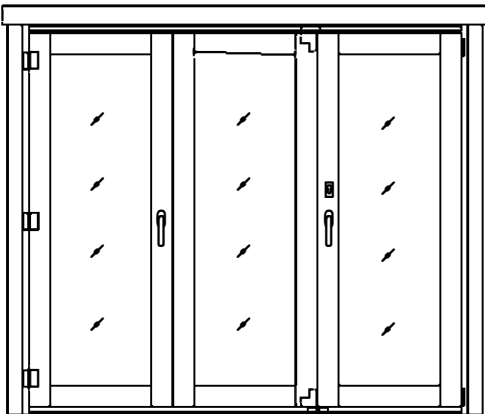

Pos	Art.Nr. WC165541 Piece list - Stückliste - Liste des pièces - Elementi - Stuklijst - Tükítabel	12/14	Q	P (mm)	L (mm)
2+ A.0P.bK	Window - Fenster - Fenetre - Finestra - Raam - Aken 552x1729 		2		
2+ A.0V.bK	Window - Fenster - Fenetre - Finestra - Raam - Aken 552x1729 		1		
3+	Door - Tür - Porte - Porte - Deur - Uks 2600x2000  <p data-bbox="260 1720 1225 1803">             General installation instructions - Allgemeine aufbauanleitung - Consignes générales de montage - Istruzioni per l'assemblaggio - Algemene opbouwhandleiding - Üldine püstitus juhend  <a href="http://www.orthez.ee/Folding_new.mp4">http://www.orthez.ee/Folding_new.mp4</a> </p> 		1		

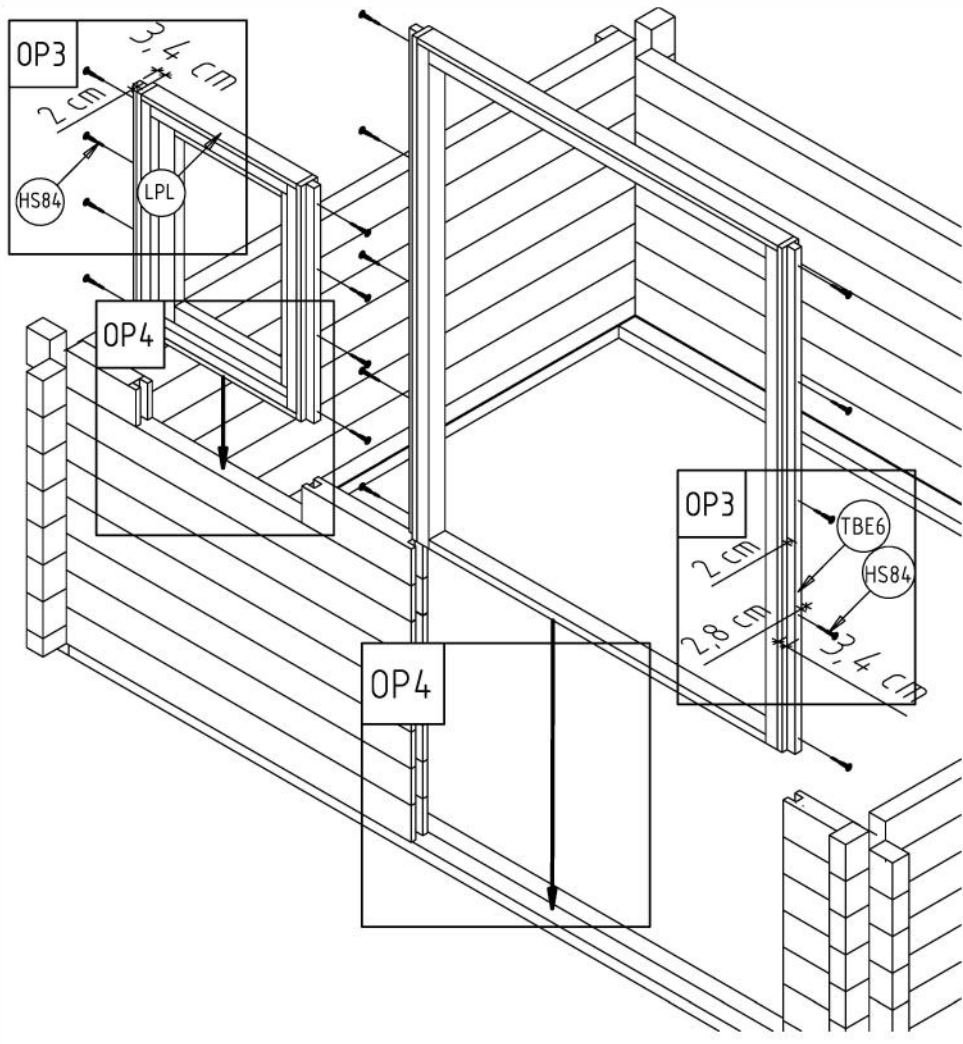
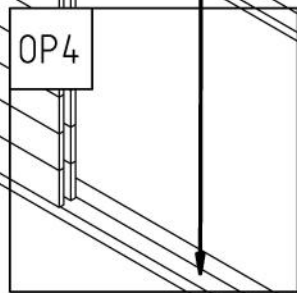
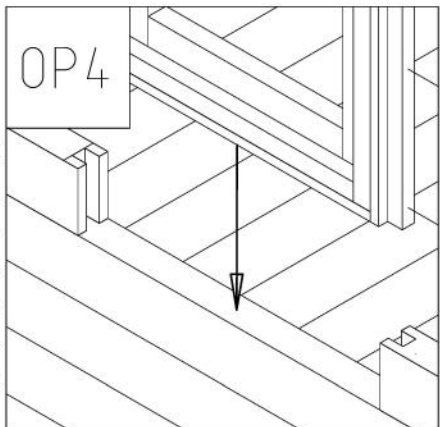
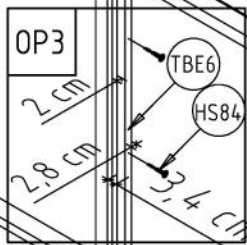
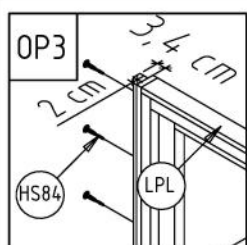
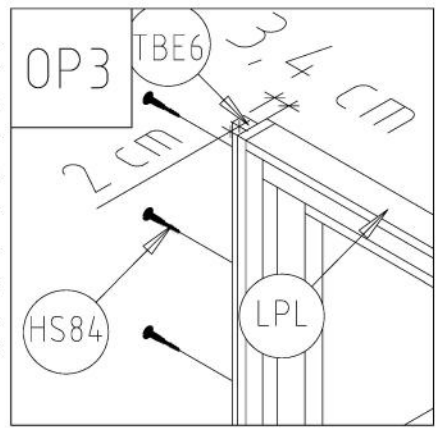
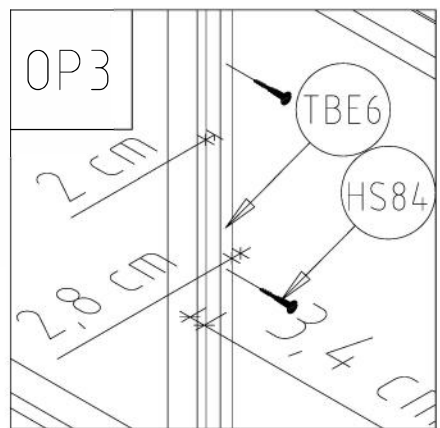
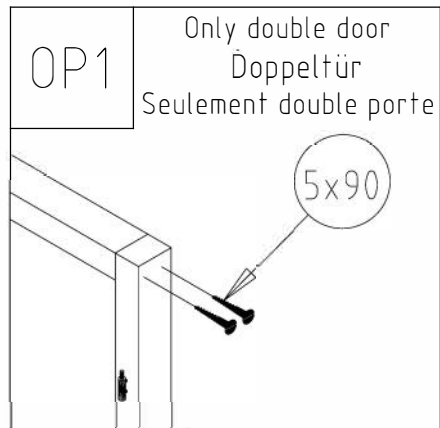
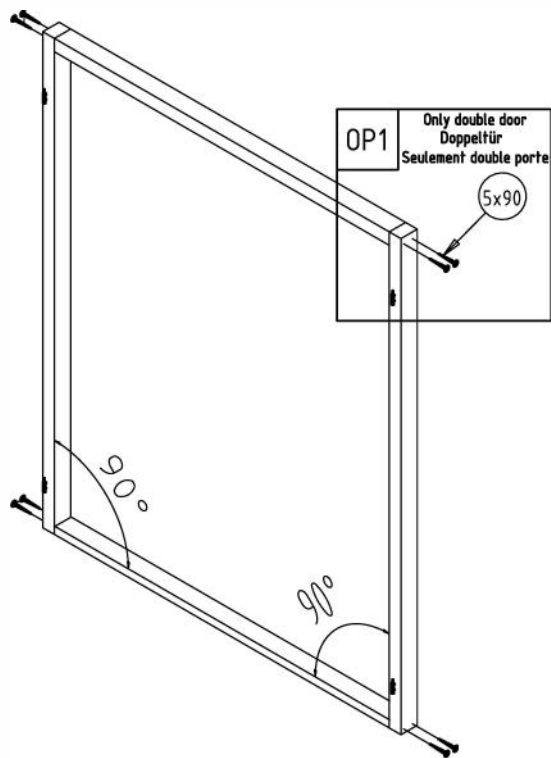

OP5

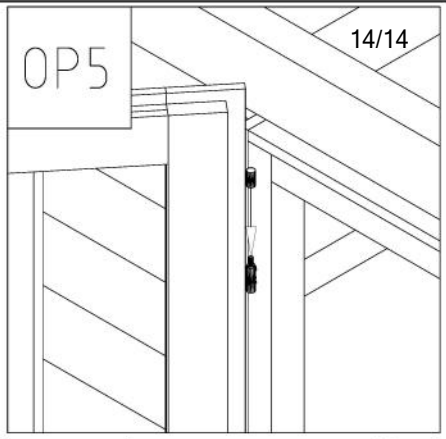

OP6

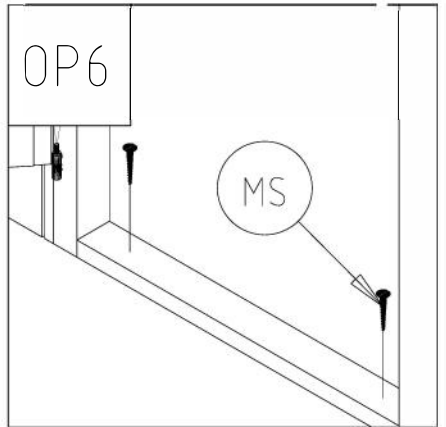

OP7

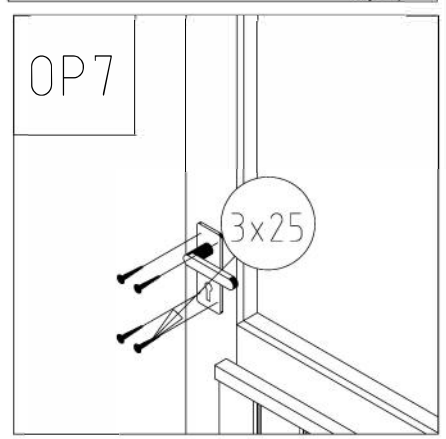

OP8

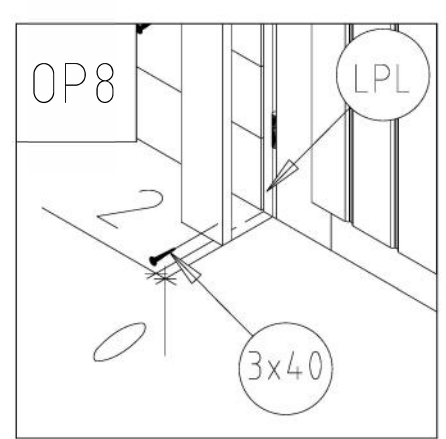

OP8

