

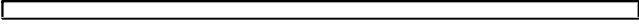

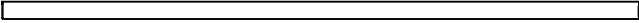

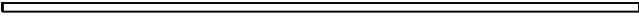





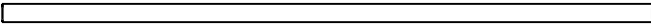
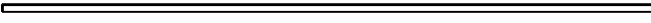
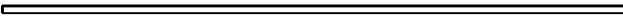

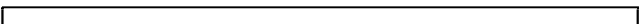





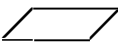

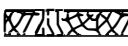
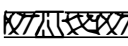





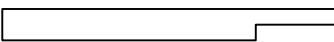

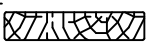
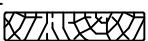



MODULARO™



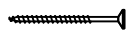
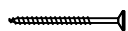
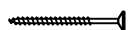
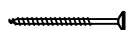



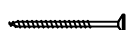



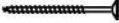
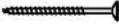

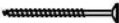
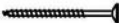

WOODEN CABIN GENOVA

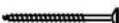
4.18 x 4.18 x 2.39 m



Pos	11.09.2019 Piece list - Stückliste - Liste des pièces - Elementi - Stuklijst - Tükítabel Art.Nr. WC165530 2/24	Q	P (mm)	L (mm)
001		21	44x114	4092
002		2	44x114	4092
003		1	44x57	4092
004		36	44x114	2026
005		4	44x114	4180
006		2	44x114	4180
IAR1	Foundation - Fundament - Fondation - Fondamenta - Fundering - Immutatud alusraam 	4	45x70	4180
IAR3	Foundation - Fundament - Fondation - Fondamenta - Fundering - Immutatud alusraam 	10	45x70	4000
IAR2	Foundation - Fundament - Fondation - Fondamenta - Fundering - Immutatud alusraam 	2	45x70	100
RV1	Lath - Pfetten - Liteau - Piccola asse - Gordingen - Roov 	1	44x44	4000
A-PR1	Roof beam - Dachbalken - Panne de toit - Perlina del tetto - Gordingen / dakbalk - Pärlin 	5	70x140	4084
FB	Floor boards - Fussbodenbretter - Lame de plancher - Pavimento - Vloerhout - Põrandalaud 	46	90x18	4072
DB	Roof boards - Dachbretter - Voliges - Perlina per tetto - Dakhout - Katuselaud 	46	90x18	4200
	Floor fillet - Fussbodenteiste - Corniere de finition du plancher - Finitura per pavimento (battisco pa) - Vloerafwerklijst - Põrandaliist 		18x18	16.32
DPL1	Roofing felt fillet - Dachpappenleiste - Baguette de fixation du feutre bitumeux - Asse per fissaggio guaina bituminosa - Afdeklijst asfaltpapier - Katusepapiiist 	2	18x58	4318
DPL2	Roofing felt fillet - Dachpappenleiste - Baguette de fixation du feutre bitumeux - Asse per fissaggio guaina bituminosa - Afdeklijst asfaltpapier - Katusepapiiist 	1	18x58	4376
TP1	Diagonal support batten - Hilfsleiste - Tasseau - Listelli per rinforzare - timmerhout - Tugilaud 	4	18x90	350
TP2	Diagonal support batten - Hilfsleiste - Tasseau - Listelli per rinforzare - timmerhout - Tugilaud 	8	18x90	1200
RS2	Railing strip - Begrenzungsleiste - Rembarde - Sbarra - Afscheidingslijst - Piirdelaud 	2	18x70	1982
RS4	Railing strip - Begrenzungsleiste - Rembarde - Sbarra - Afscheidingslijst - Piirdelaud 	2	18x70	2000
RS7	Railing strip - Begrenzungsleiste - Rembarde - Sbarra - Afscheidingslijst - Piirdelaud 	2	18x90	2116
RS8	Railing strip - Begrenzungsleiste - Rembarde - Sbarra - Afscheidingslijst - Piirdelaud 	2	18x90	2126
RS9	Railing strip - Begrenzungsleiste - Rembarde - Sbarra - Afscheidingslijst - Piirdelaud 	1	18x90	4000

Pos	11.09.2019 Piece list - Stückliste - Liste des pièces - Elementi - Stuklijst - Tükítabel Art.Nr. WC165530 3/24	Q	P (mm)	L (mm)
RS10	Railing strip - Begrenzungsleiste - Rembarde - Sbarra - Afscheidingslijst - Piirdelaud 	1	18x90	4020
P1	Post - Pfosten - Poteau - Piede registrabile - Stijl - Post 	2	88x88	2330
P2	Post - Pfosten - Poteau - Piede registrabile - Stijl - Post 	2	44x44	2260
P3	Post - Pfosten - Poteau - Piede registrabile - Stijl - Post 	2	90x90	2220
GL2	Fascia board - Traufbrett - Bandeau de toit - Finitura lati tetto - Gevellijst - Räästalaud 	2	18x120	4340
GL1	Fascia board - Traufbrett - Bandeau de toit - Finitura lati tetto - Gevellijst - Räästalaud 	2	18x120	4376
DRV-1	Roof edge reinforcement - Dachrandverstärkung - Corniere de renfort de bord de toit - Rinforzo x tetto - Dakrand versterking - Räästatugevdus 	2	80x44	4180
DRV-2	Roof edge reinforcement - Dachrandverstärkung - Corniere de renfort de bord de toit - Rinforzo x tetto - Dakrand versterking - Räästatugevdus 	2	80x44	4340
FF2	Fixing fillet - Fixierungsleiste - Profil de fixation - Massello di fissaggio - Bevestiging lijstwerk - Tenderliist 	4	15x45	2025
FF	Fixing fillet - Fixierungsleiste - Profil de fixation - Massello di fissaggio - Bevestiging lijstwerk - Tenderliist 	2	18x44	2030
FF3	Fixing fillet - Fixierungsleiste - Profil de fixation - Massello di fissaggio - Bevestiging lijstwerk - Tenderliist 	2	38x46	1980
FF4	Fixing fillet - Fixierungsleiste - Profil de fixation - Massello di fissaggio - Bevestiging lijstwerk - Tenderliist 	2	38x46	2026
FF5	Fixing fillet - Fixierungsleiste - Profil de fixation - Massello di fissaggio - Bevestiging lijstwerk - Tenderliist 	1	38x46	3960
HS32	Screw for door jamb - Schraube für türrahmen - Vis de fixation partie haute avec montants du cadre de porte - Viti x fissaggio montanti porte - Schroef voor deurkozijn - Kruvi ukse lengile 	8	4x25	
HS14	Screw for wall details - Schraube für wand details - Vis pour mur details - Viti per elementi della porta - Schroef voor wand details - Kruvi seinte montaažiks 	300	4.5x80	
HS12	Screw for doorstep - Schrauben für swelle - Vis pour fixation barre de seuil - Vite per soglia della porta - Schroef voor deurdorpel - Kruvi lävepakule 	12	4x40	
HS12	Screw for metal corner - Holzschraube für metallwinkel - Vis de fixation des cornieres en métal - Viti per fissare suadretta di metallo di giunzione - Schroef voor metalen hoek - Kruvi nurgikule 	40	4x40	
HS12	Screw for covering moulding - Schrauben für deckungsprofil - Vis de fixation profils horizontaux haut inférieur et extérieur d'encadrement de porte - Vite per cornice di copertura - Schroef voor afdekprofiel - Kruvi piirdelauale 	58	4x40	
HS12	Screw for diagonal support batten - Schraube für dachlatte - Vis de tasseau - Vite per listelli per rinforzare - Schroef voor timmerhout - Kruvi tugilauale 	16	4x40	
HS12	Screw for fascia boards - Schrauben für traufbretter - Vis pour fixation bandeau de toit - Viti x striscia del tetto - Schroef voor gevellijst - Kruvi räästalauale 	36	4x40	
HS12	Screw for beam holder - Schrauben für balkenhalter - Vis de fixation support "u" galvanisé - Vite per trave di sostegno - Schroef voor bevestiging balkhouder (gordingschoen) - Kruvi talakingale 	120	4x40	
HS12	Screw for fixing fillet of door and window - Schrauben für fixierungsleiste - Vis pour profil vertical de fixation pour ouvertures des fenetres et portes - Viti per massello di fissaggio - Schroeven voor bevestiging van deur en raam lijsten - Kruvi tenderliistufudele 	36	4x40	
HS12	Screw for diagonal support batten - Schraube für dachlatte - Vis de tasseau - Vite per listelli per rinforzare - Schroef voor timmerhout - Kruvi tugilauale 	24	4x40	

Pos	11.09.2019 Piece list - Stückliste - Liste des pièces - Elementi - Stuklijst - Tükítabel Art.Nr. WC165530 4/24	Q	P (mm)	L (mm)
HS12	Screw for door jamb - Schraube für Türrahmen - Vis de fixation partie haute avec montants du cadre de porte - Viti x fissaggio montanti porte - Schroef voor deurkozijn - Kruvi ukse lengile 	18	4x40	
HS33	Screw for door jamb - Schraube für Türrahmen - Vis de fixation partie haute avec montants du cadre de porte - Viti x fissaggio montanti porte - Schroef voor deurkozijn - Kruvi ukse lengile 	24	5x40	
HS16	Screw for foundation - Schrauben zur Befestigung Fundament - Vis de fixations des poutrelles de fondations - Viti x fondamenta - Schroef voor fundering - Kruvi alusraamile 	20	5x90	
HS16	Screw for post - Schrauben für Pfosten - Vis de fixation des poteaux - Viti per inviare - Schroef voor stijlen - Kruvi postile 	14	5x90	
HS16	Screw for roof edge reinforcement - Schrauben für Dachrandverstärkung - Vis pour fixation corniere renfort de bord de toit - Viti x rinforzo bordo tetto - Schroef voor dakrand versterking - Kruvi räästatugevdusele 	36	5x90	
HS16	Screw for wall details - Schraube für Wand details - Vis pour mur details - Viti per elementi della porta - Schroef voor wand details - Kruvi seinadetailidele 	7	5x90	
HS16	Screw for foundation - Schrauben zur Befestigung Fundament - Vis de fixations des poutrelles de fondations - Viti x fondamenta - Schroef voor fundering - Kruvi alusraamile 	12	5x90	
HS16	Screw for door jamb - Schraube für Türrahmen - Vis de fixation partie haute avec montants du cadre de porte - Viti x fissaggio montanti porte - Schroef voor deurkozijn - Kruvi ukse lengile 	19	5x90	
HS22	Screw for 1. wall beam - Schraube für 1. Bohlenreihe - Vis de fixations 1ere rangée de madriers avec poutrelles de fondations - Vite fissaggio alle fondamenta - Schroef voor 1 wandbalk - Kruvi poollauale 	7	6x150	
HS23	Screw for wall details - Schraube für Wand details - Vis pour mur details - Viti per elementi della porta - Schroef voor wand details - Kruvi seinadetailidele 	202	6x180	
HS21	Screw for roof lath - Schraube für Dachlatte - Vis pour latte - Vite per listello del tetto - Schroef voor daklat - Kruvi roovile 	8	6x80	
NF2	Zn nail for floor fillet - Zn Nägel für Fussbodenleiste - Pointe pour corniere de finition du plancher - Chiodi x fissaggio pavimento - Spijker(nagel) voor vloer afdeklijst - Nael põrandaliistule 	32	1.4x40	
SH44	Hammer block - Schlagholz - Calle de frappe - Blocco di legno da usare come cuscinetto quando si usa il martello - Slagklos - Löögiklots 	1		
NF4	Zn nail for roof - Zn Nägel für Dachbretter - Pointe pour fixation voliges de toit - Chiodi x perline tetto - Spijker(nagel) voor dakhout - Nael katuselauale 	658	2x50	
NF4	Zn nail for floor - Zn Nägel für Fussbodenbretter - Clous pour plancher - Chiodi x perline pavimento - Spijker(nagel) voor vloer - Nael põrandalauale 	376	2x50	
MW	Metal corner - Metallwinkel - Corniere en métal - Angolo di metallo - Metalen hoek - Nurgik 	4	120x80x40	
NF5	Zn nail for roofing felt fillet - Zn Nägel für Dachpappenleiste - Pointe pour baguette de fixation feutre bitumeux - Chiodi x carta bituminosa x tetto - Spijker(nagel) voor asfaltpapier afdeklijst - Papiliistunael 	27	2x40	
BM	Beam holder - Balkenhalter - Support en u galvanisé - Supporto della trave - Balkendrager (gording schoen) - Talaking 	10	70x125	

Groundplan - Grundplan - Plan de masse - Planimetria -
Plattegrond - Põhiplaan

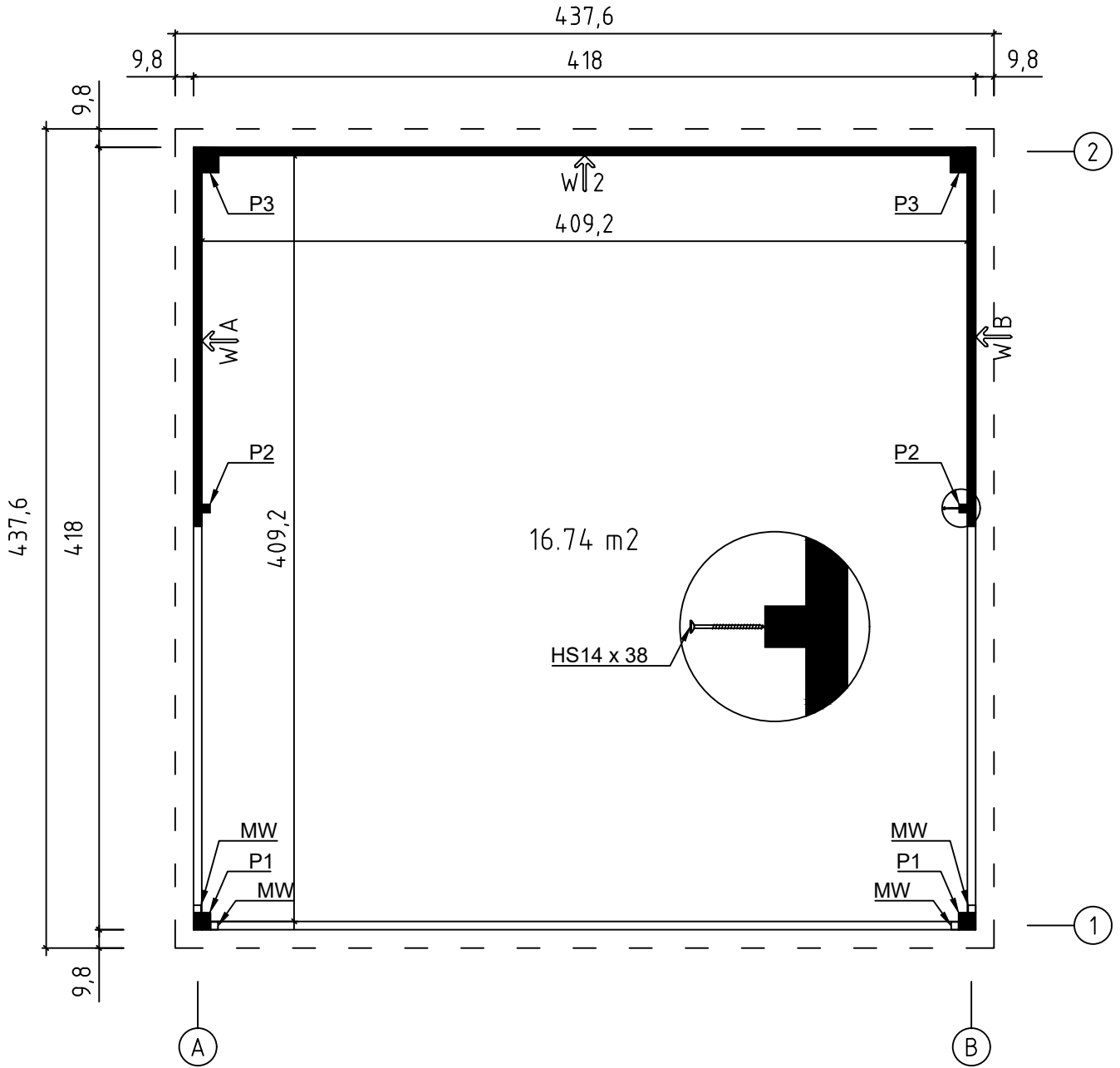

Foundation - Fundament - Fondation - Fundamenta -
Fundering - Immutatud alusraam

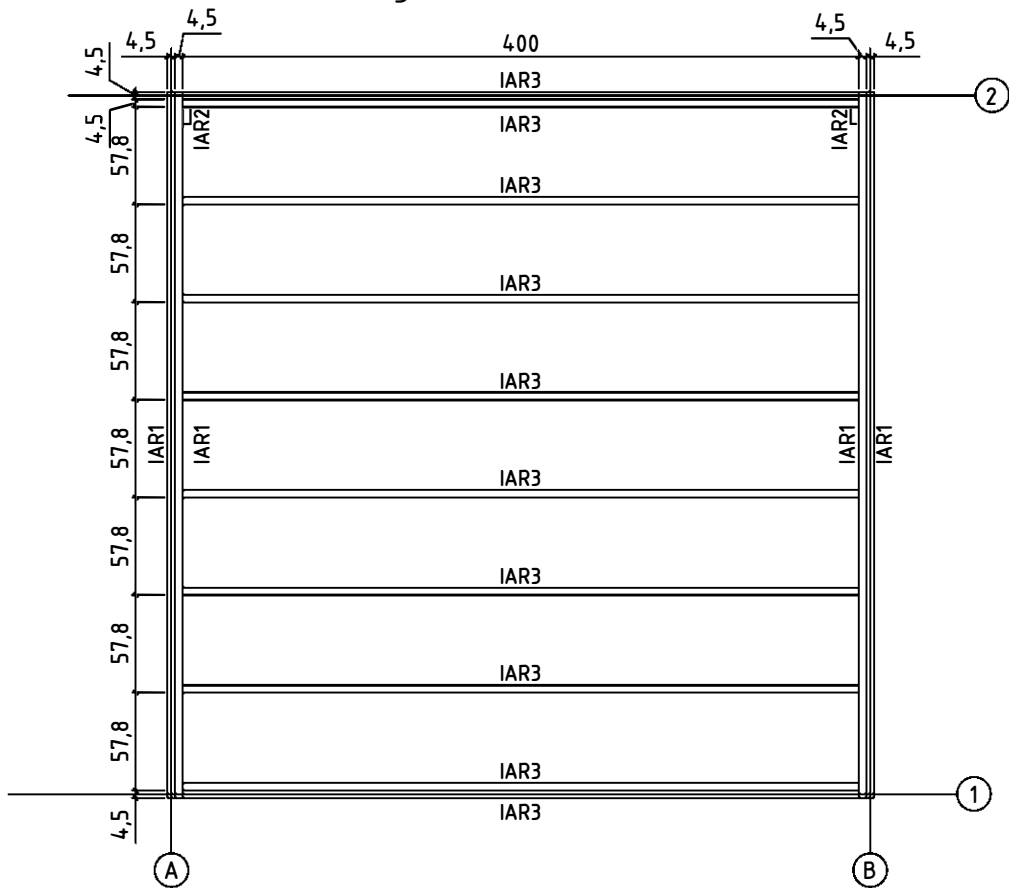

Floor boards - Fussbodenbretter - Plan pose
plancher - Pavimento - Vloerhout - Põrandalaudis

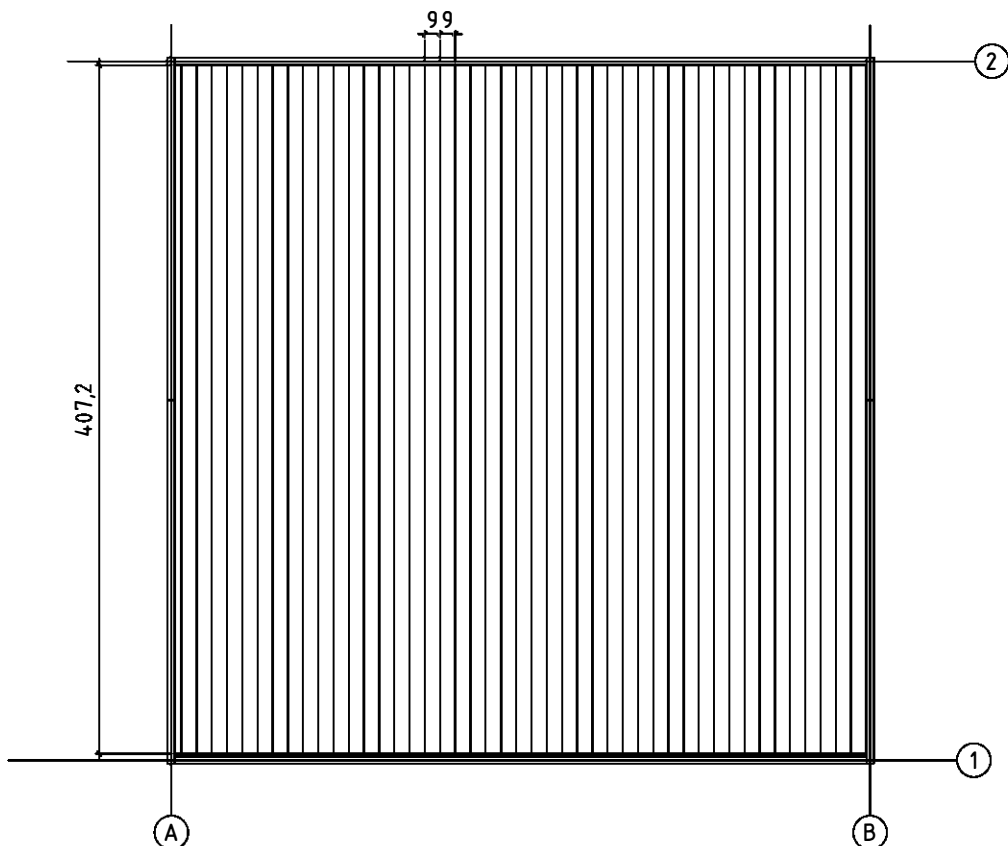

Art.Nr. WC165530

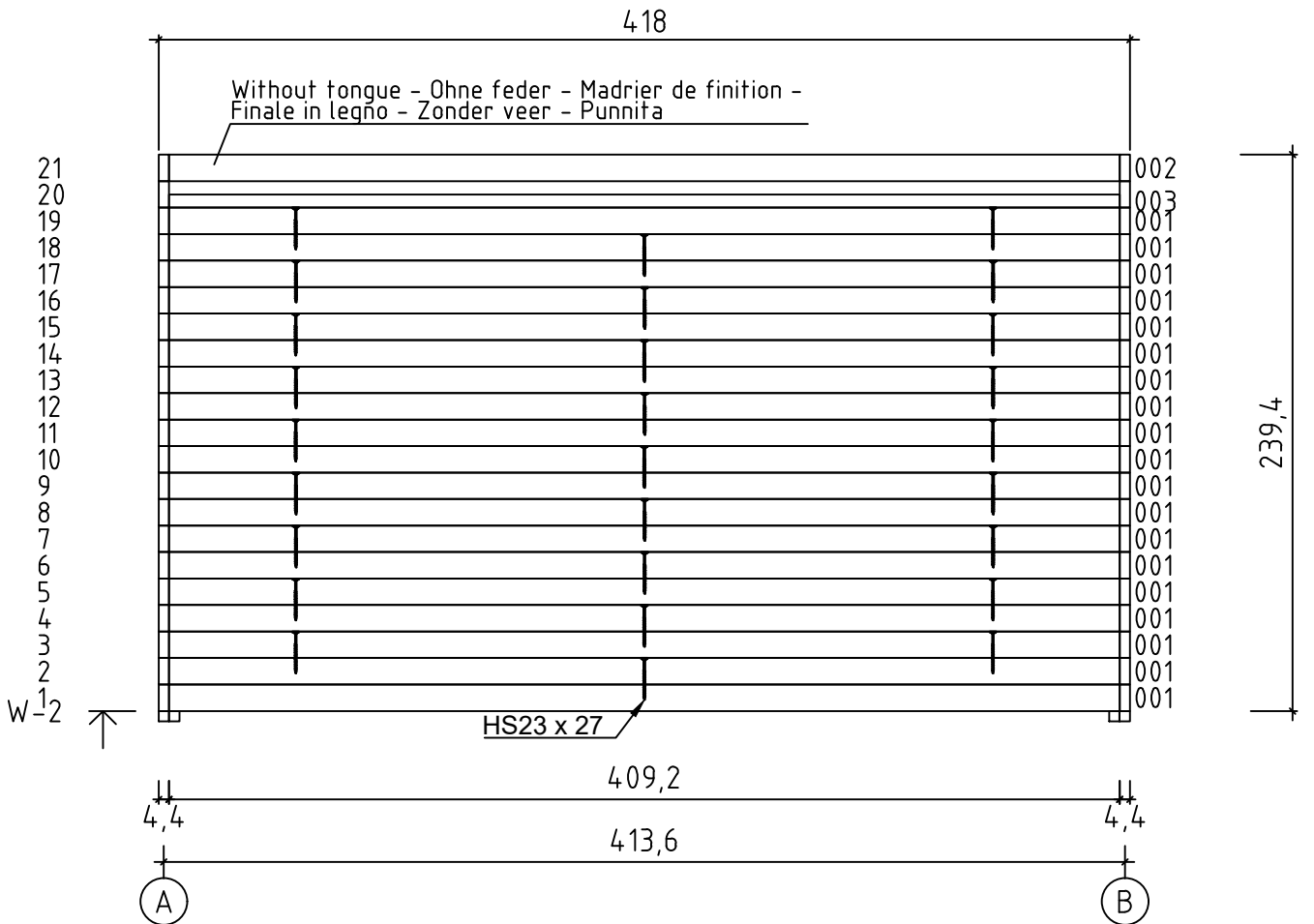
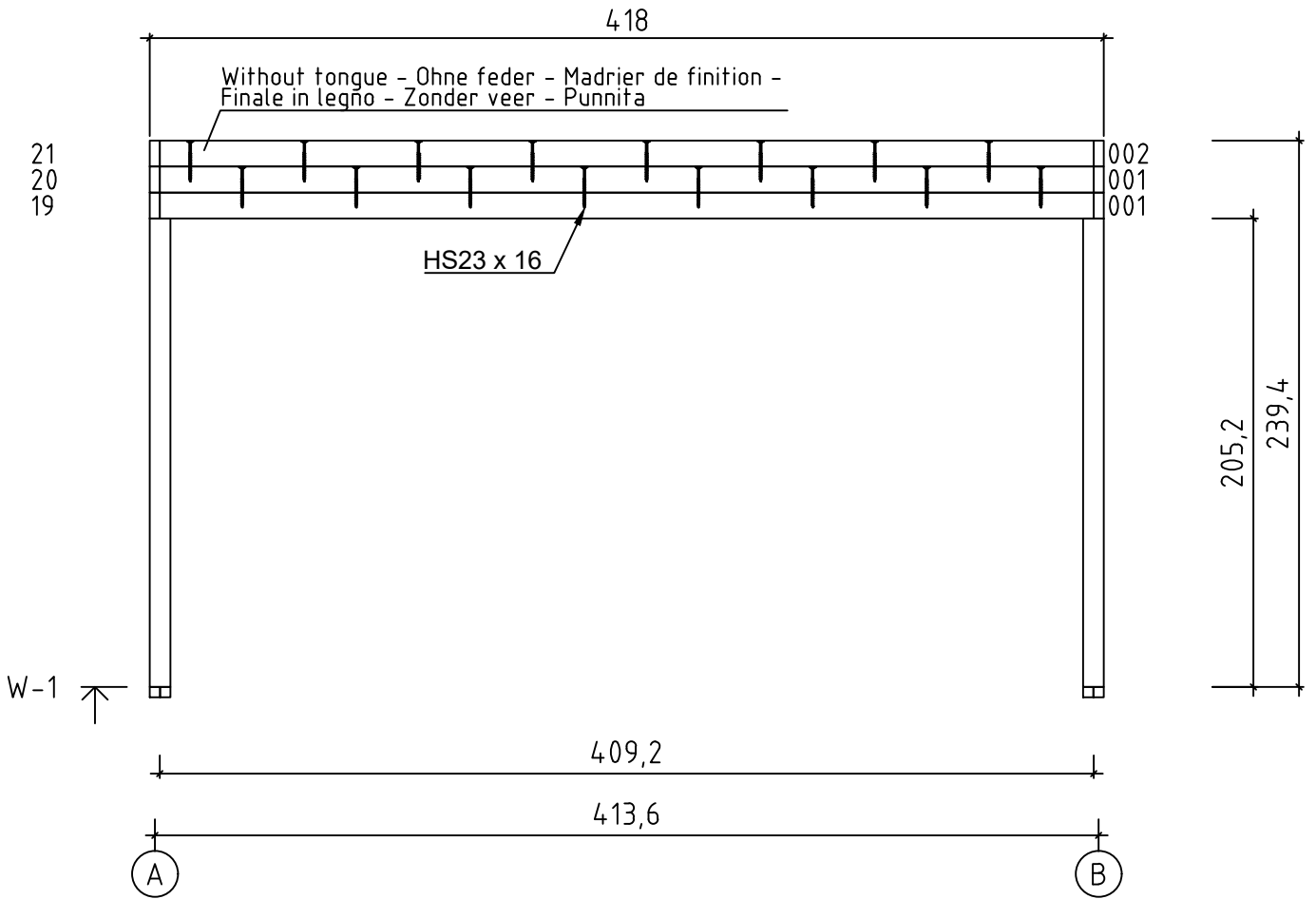

Art.Nr. WC165530

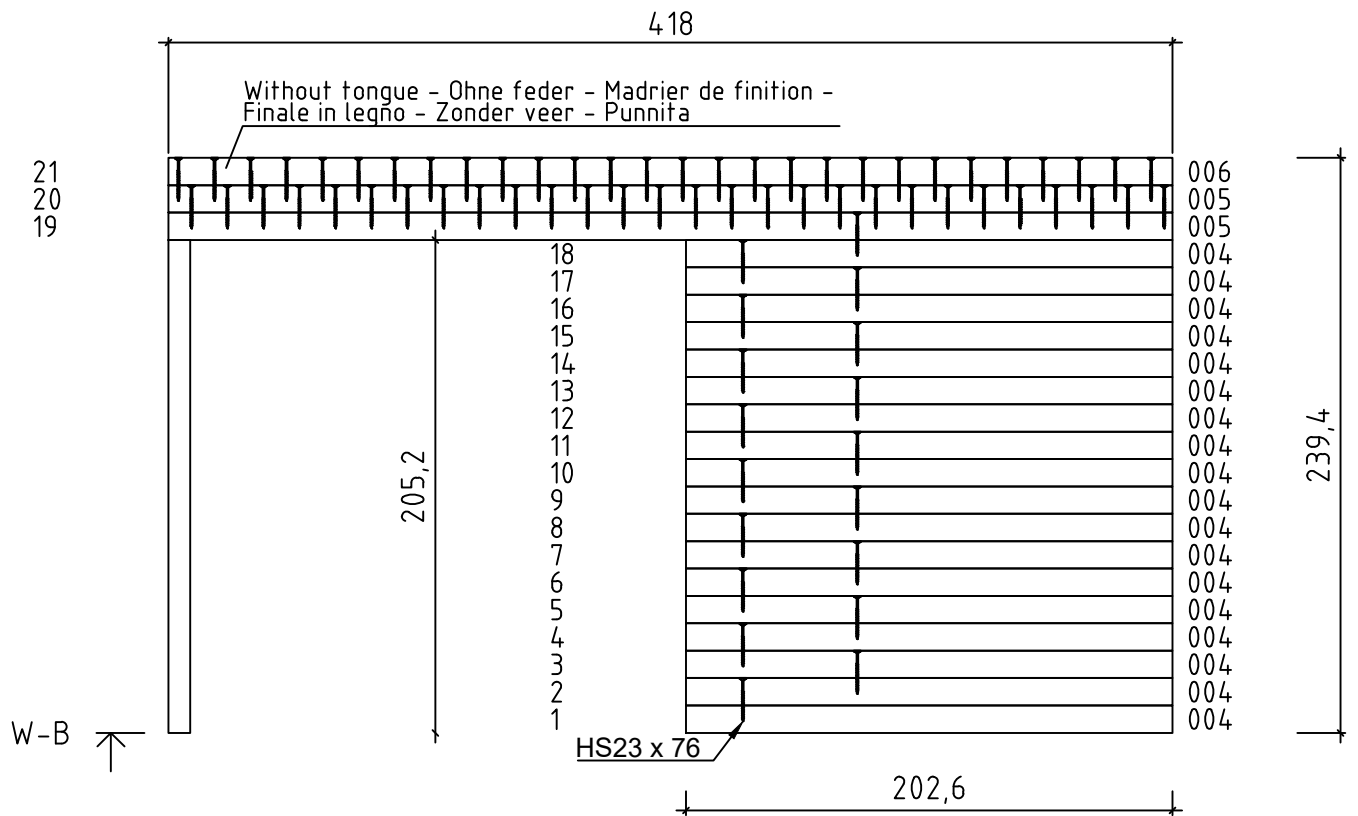
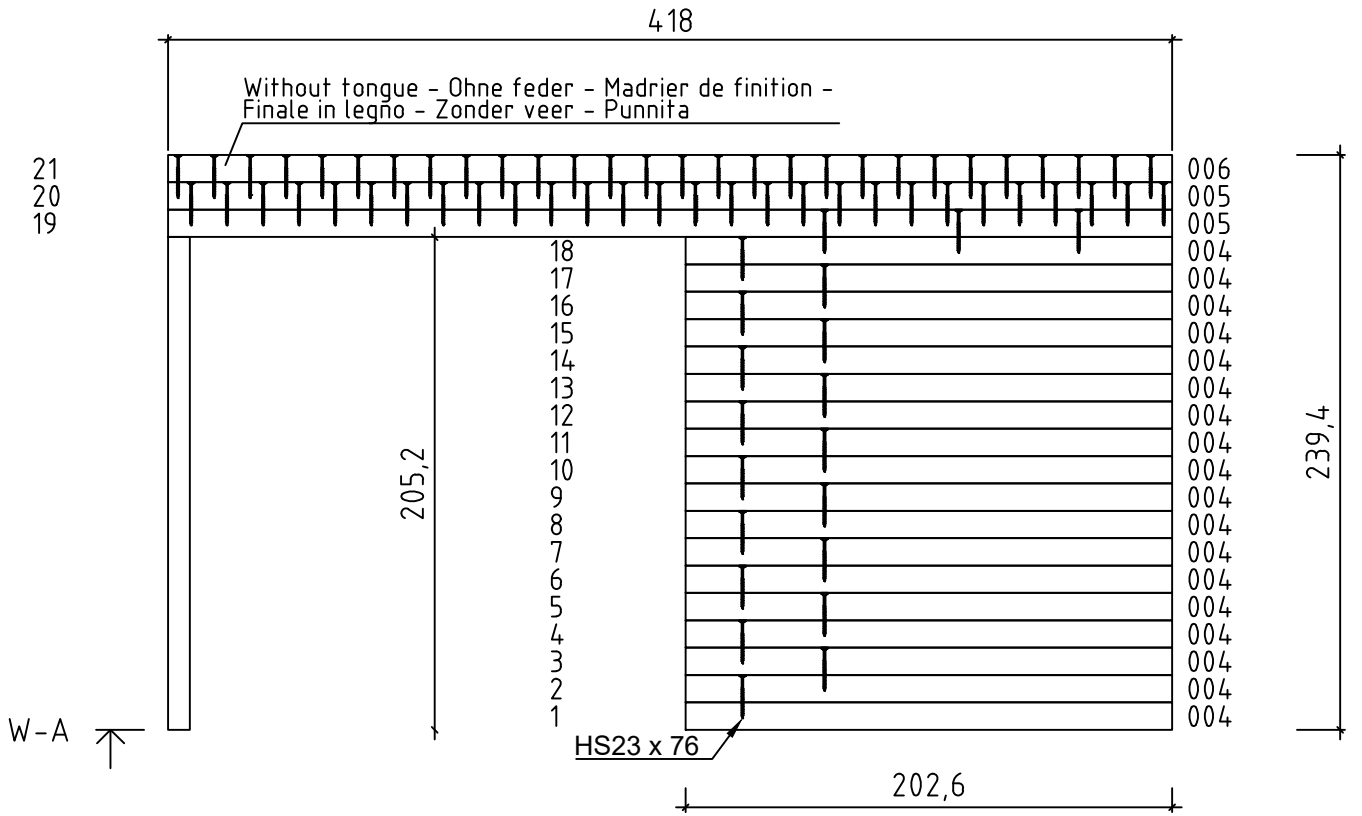

Art.Nr. WC165530

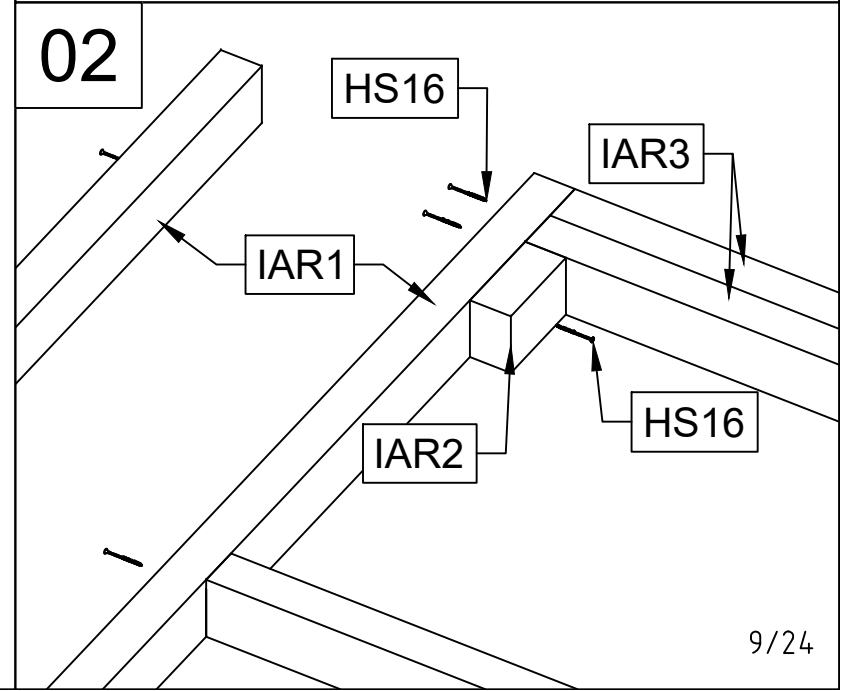
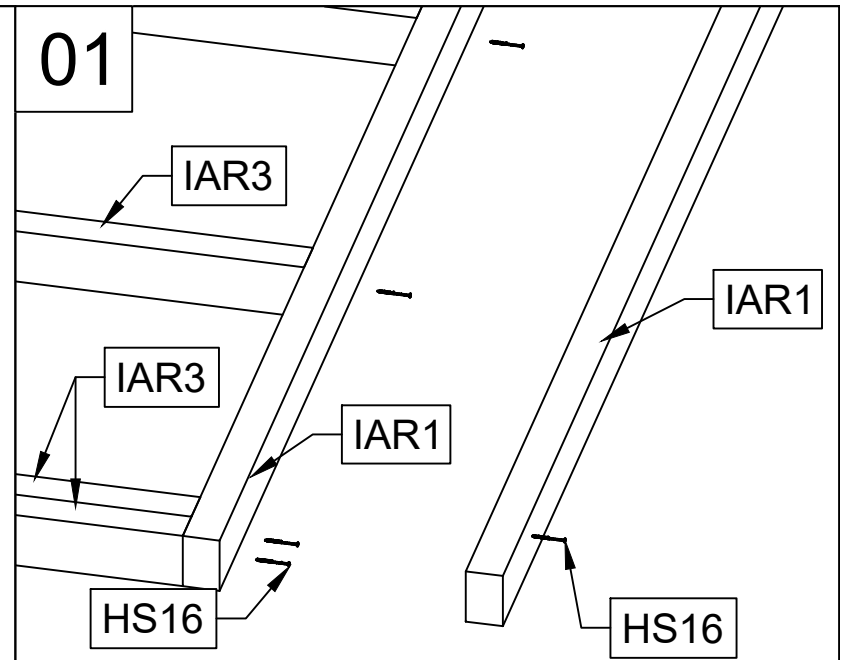
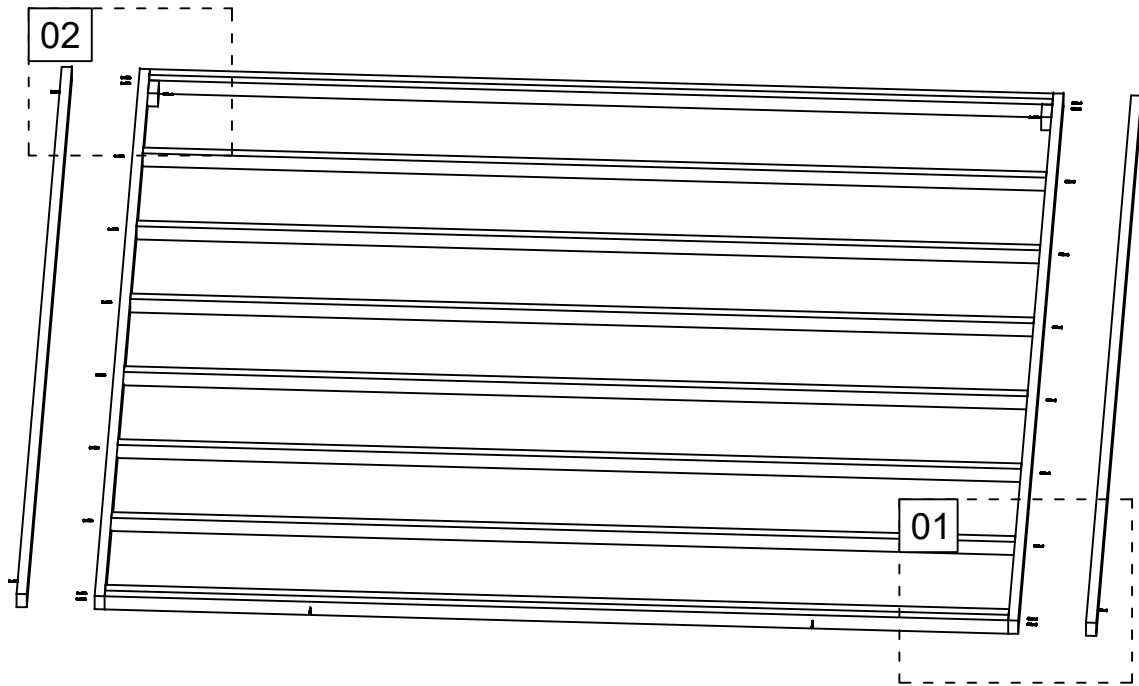

Art.Nr. WC165530

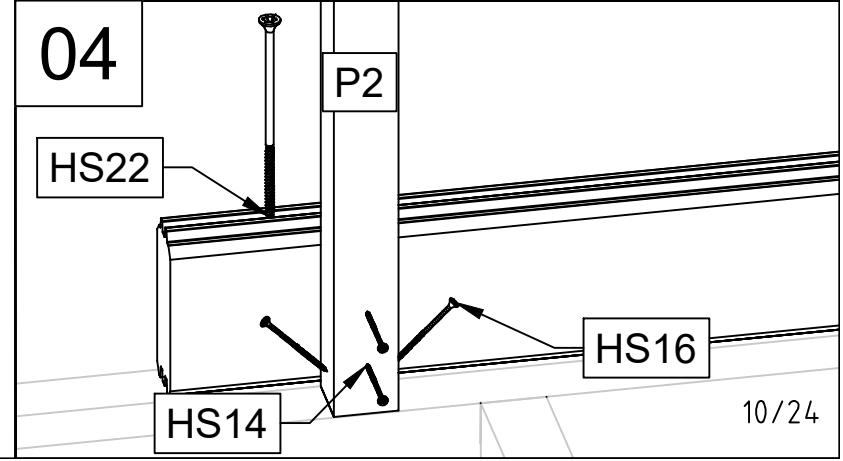
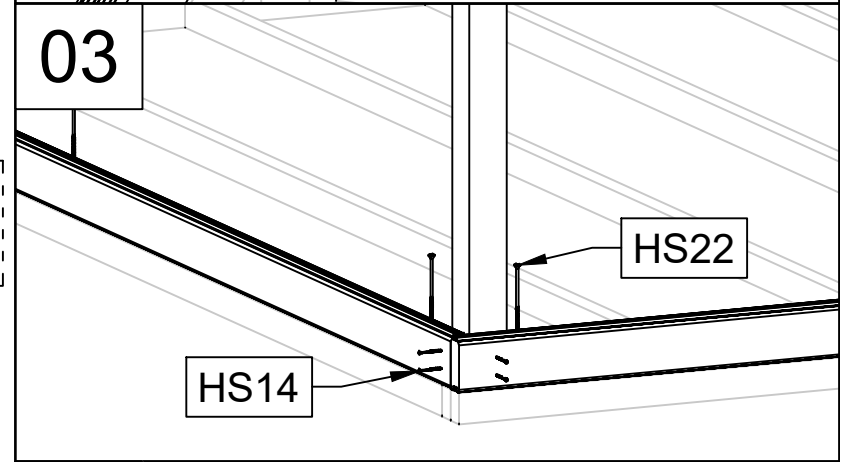
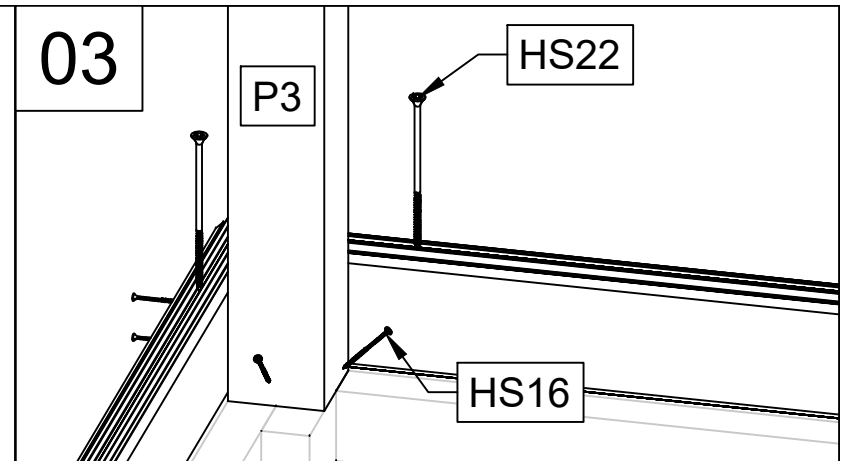
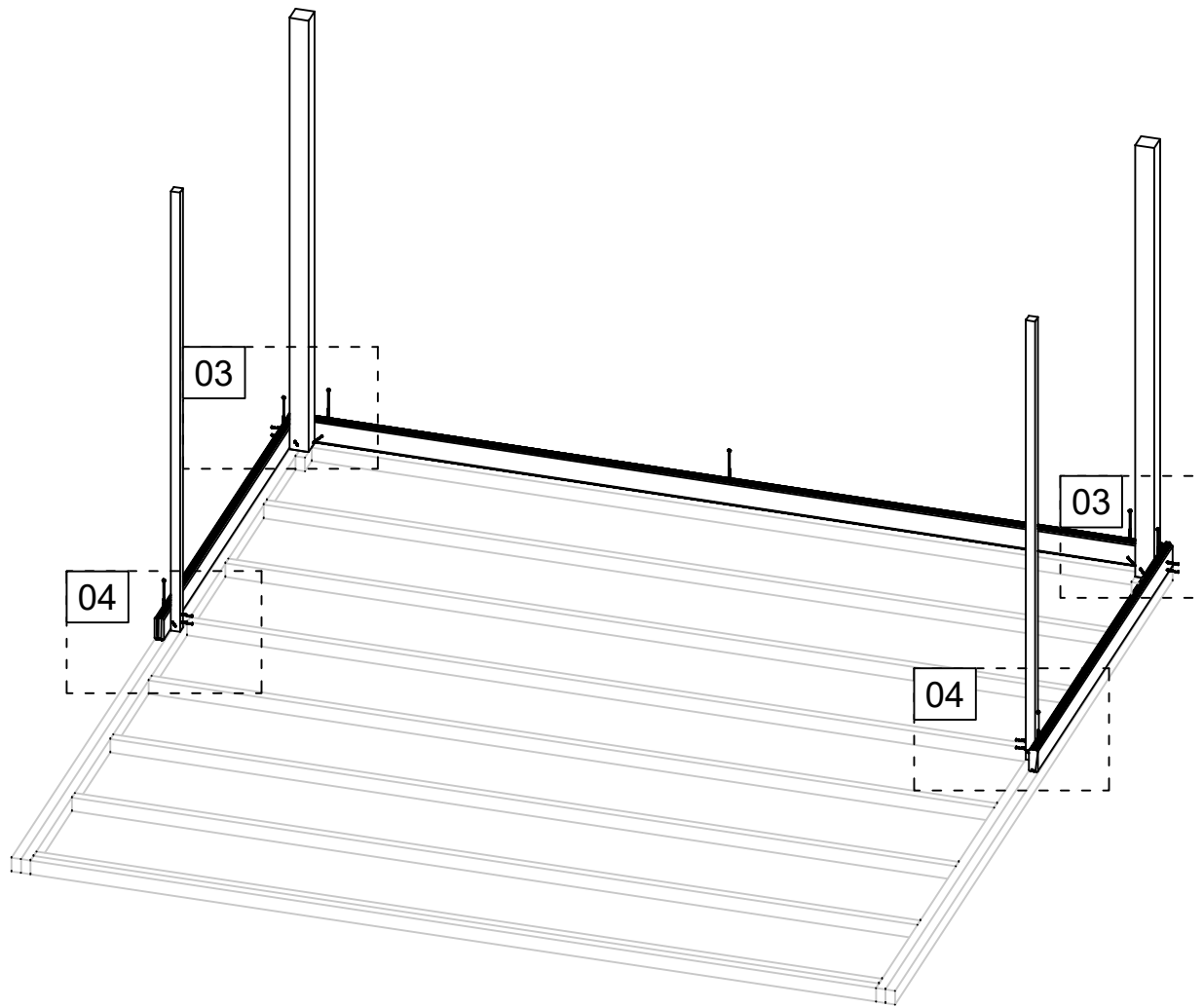

Art.Nr. WC165530

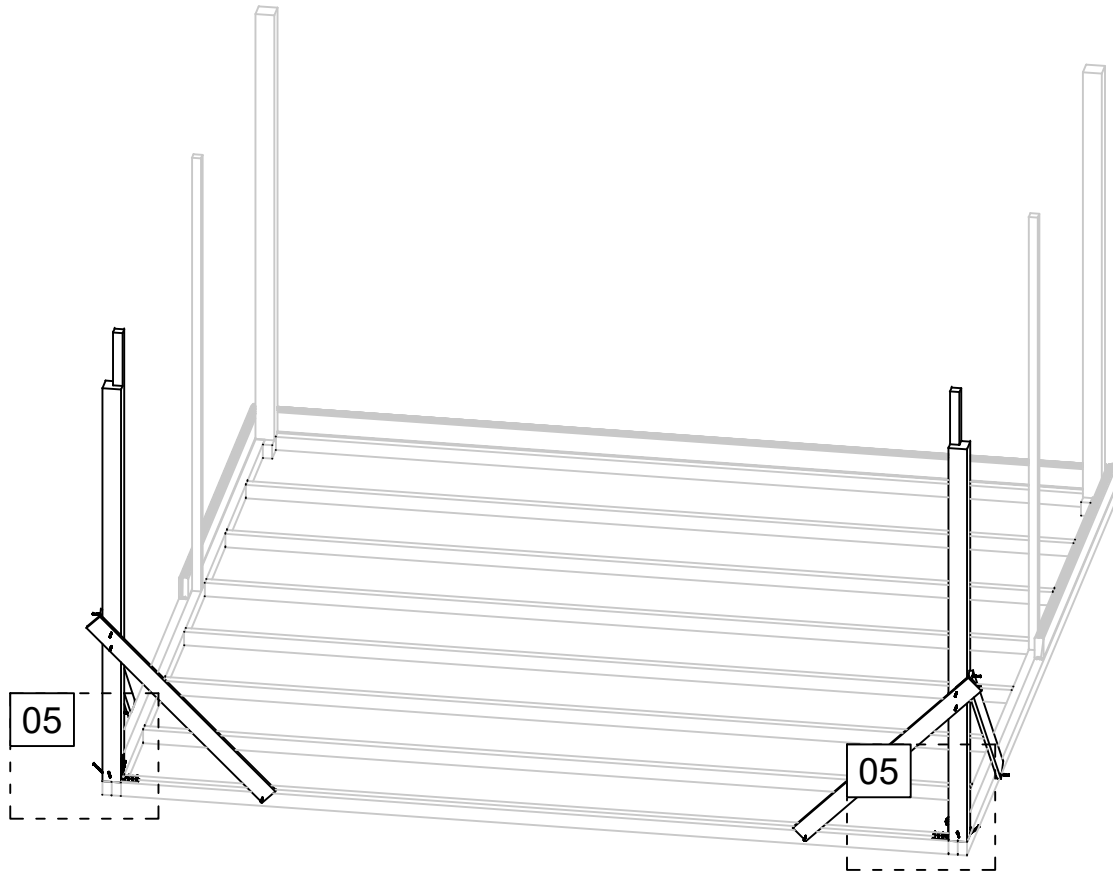

05

HS12

TP2

90°

90°

HS16

05

MW

HS12
10 pcs.

Art.Nr. WC165530

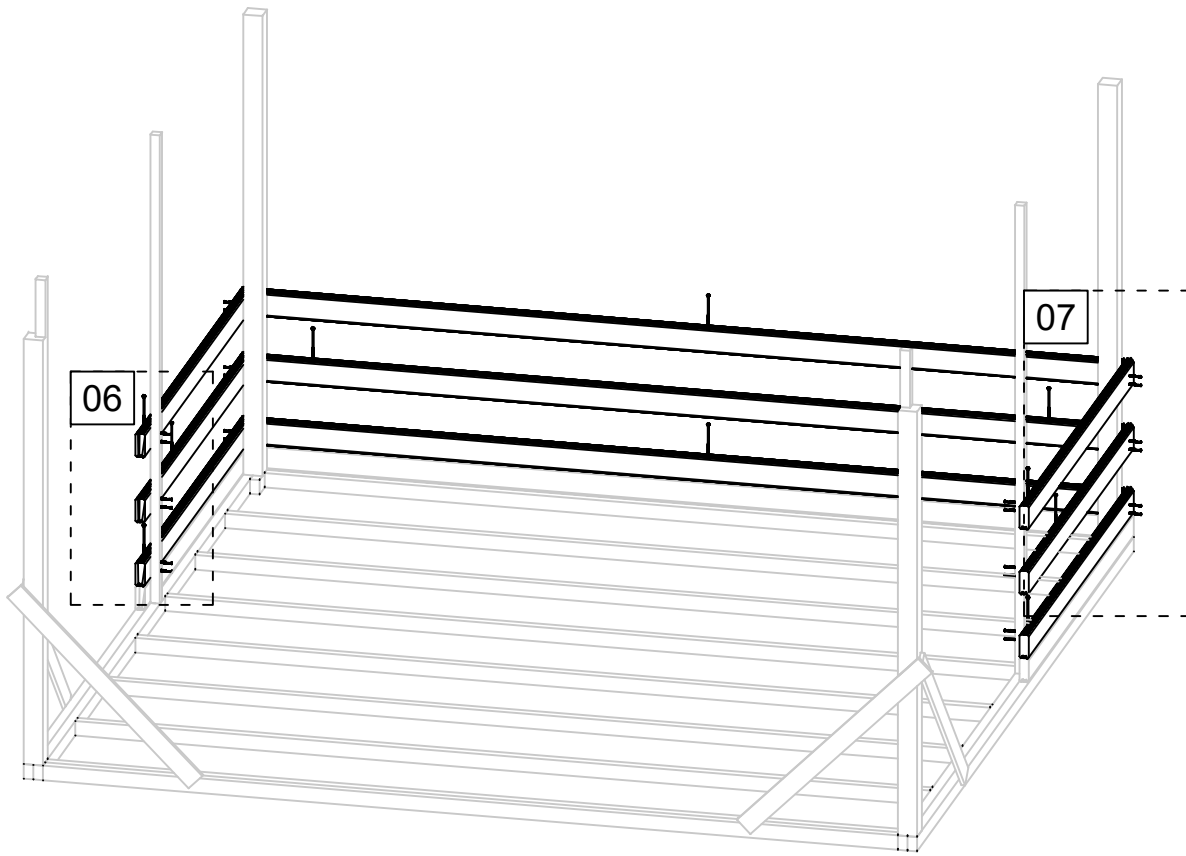

06

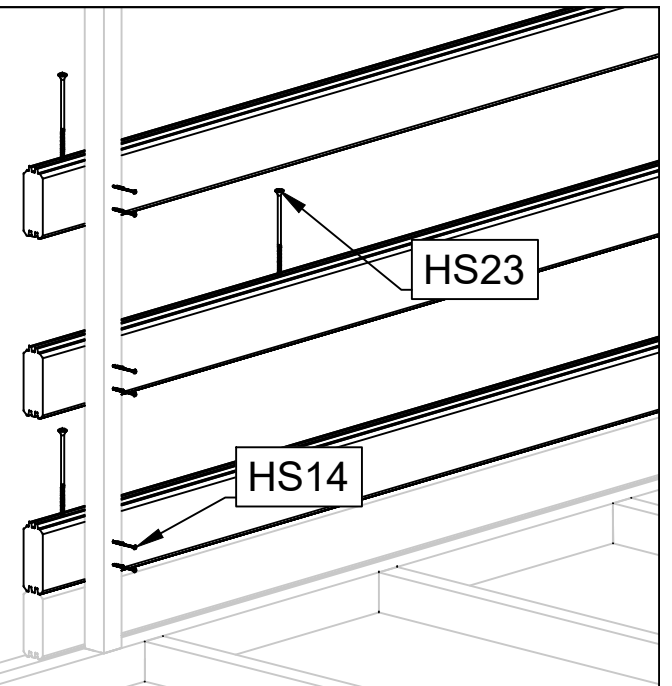

07

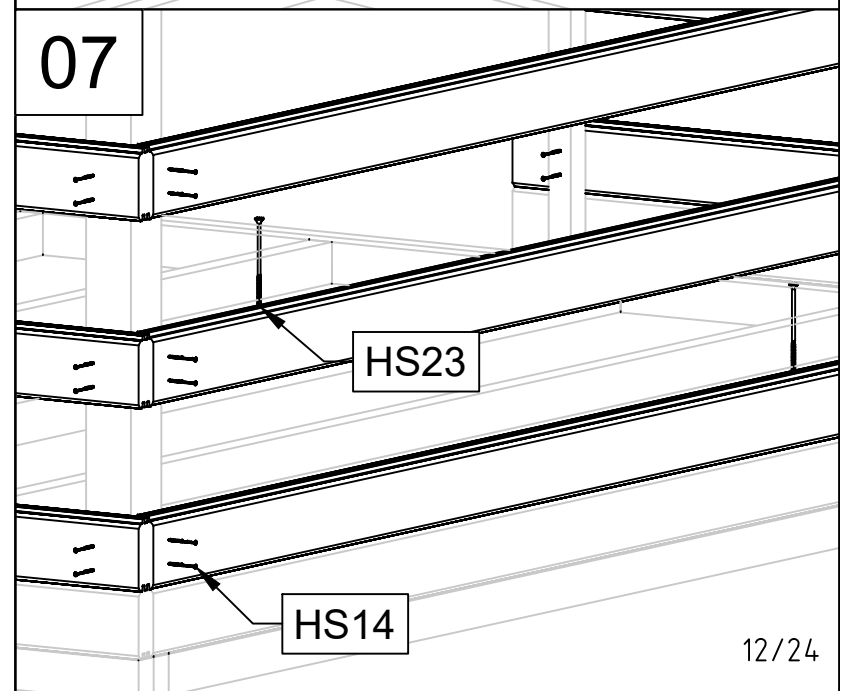

Art.Nr. WC165530

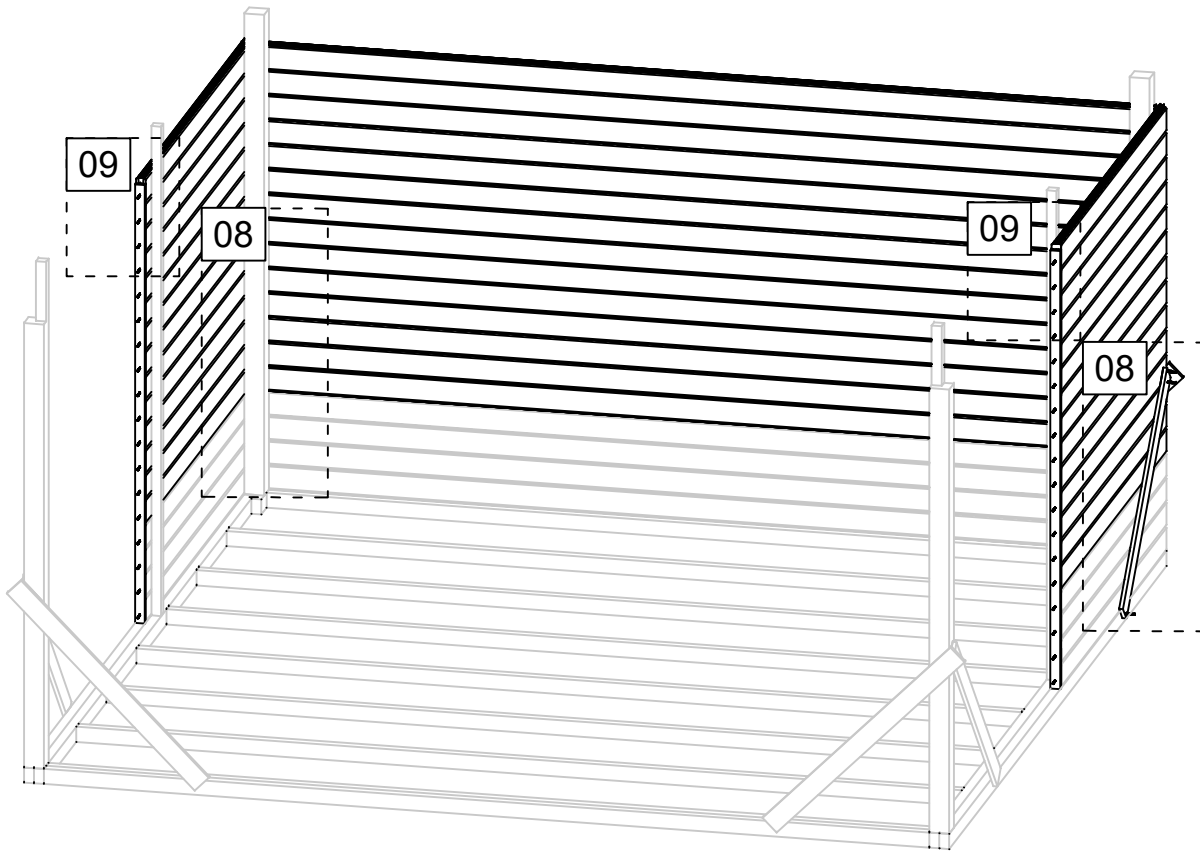

08

TP2

HS12

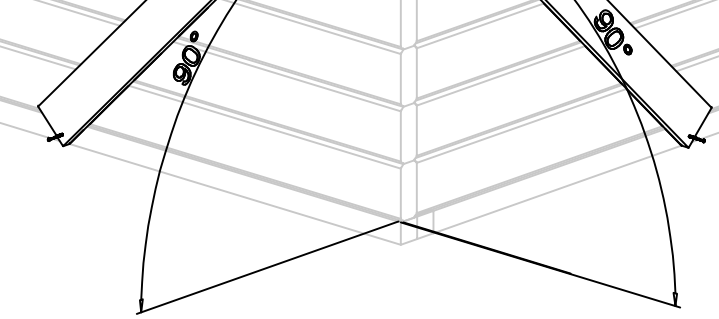

09

HS12

FF

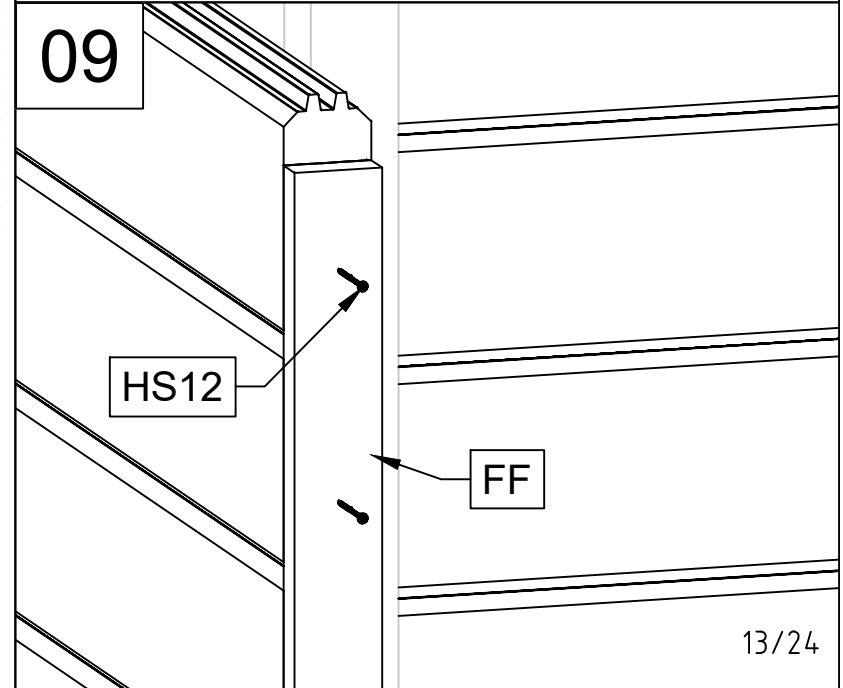

Art.Nr. WC165530

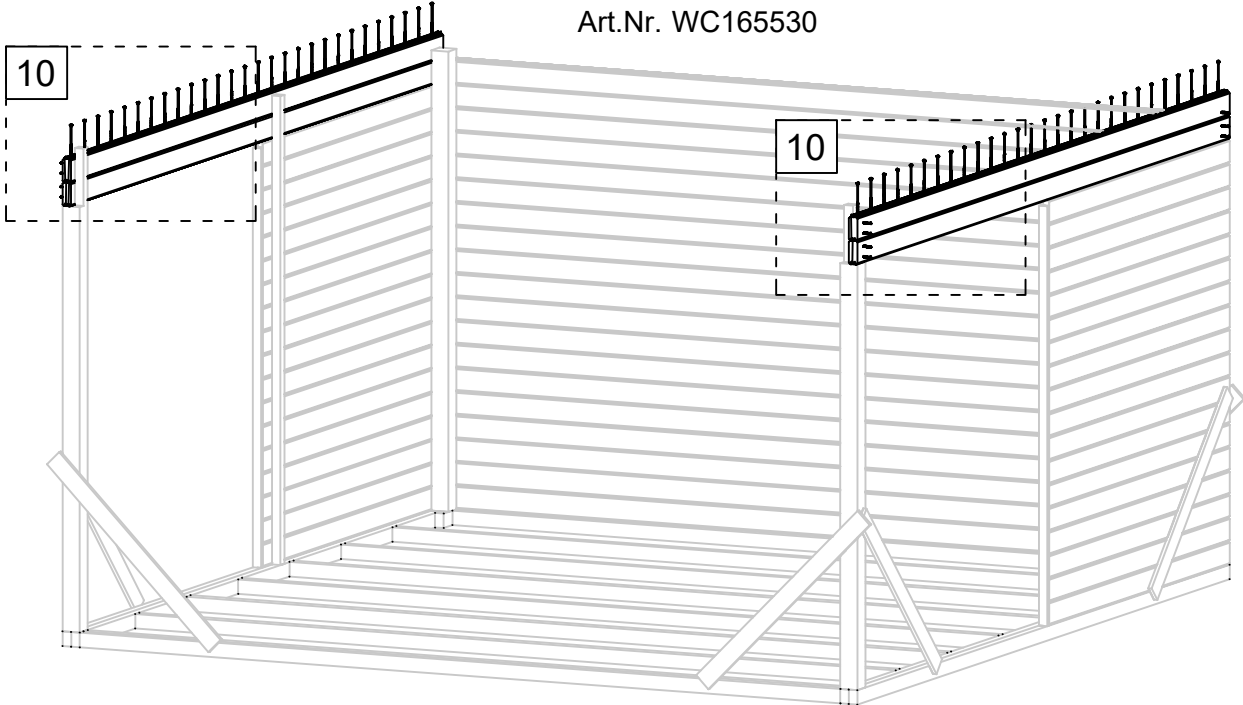

10

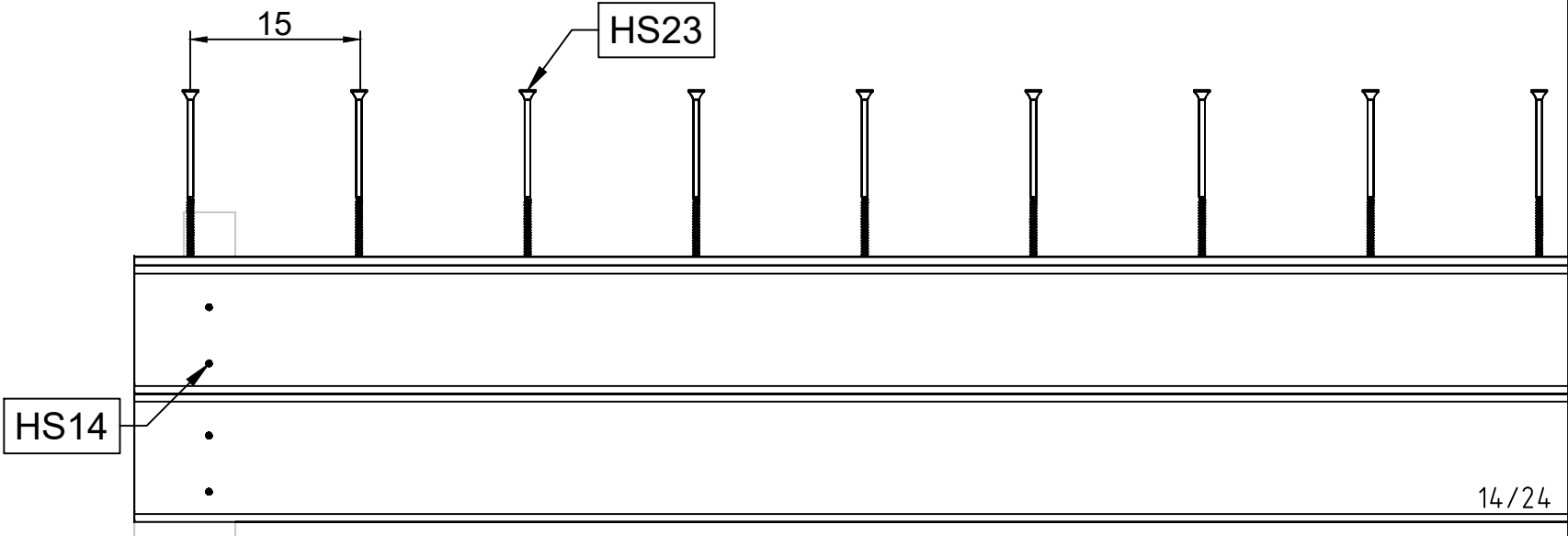

Art.Nr. WC165530

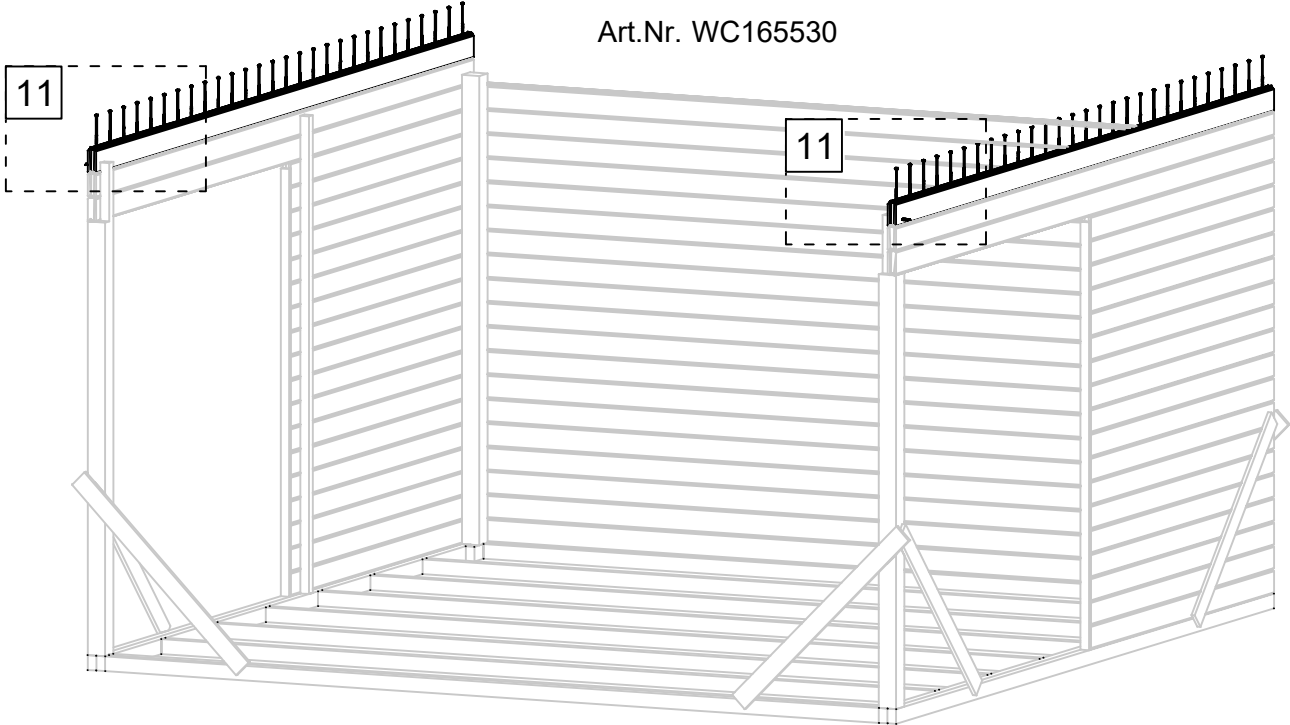

11

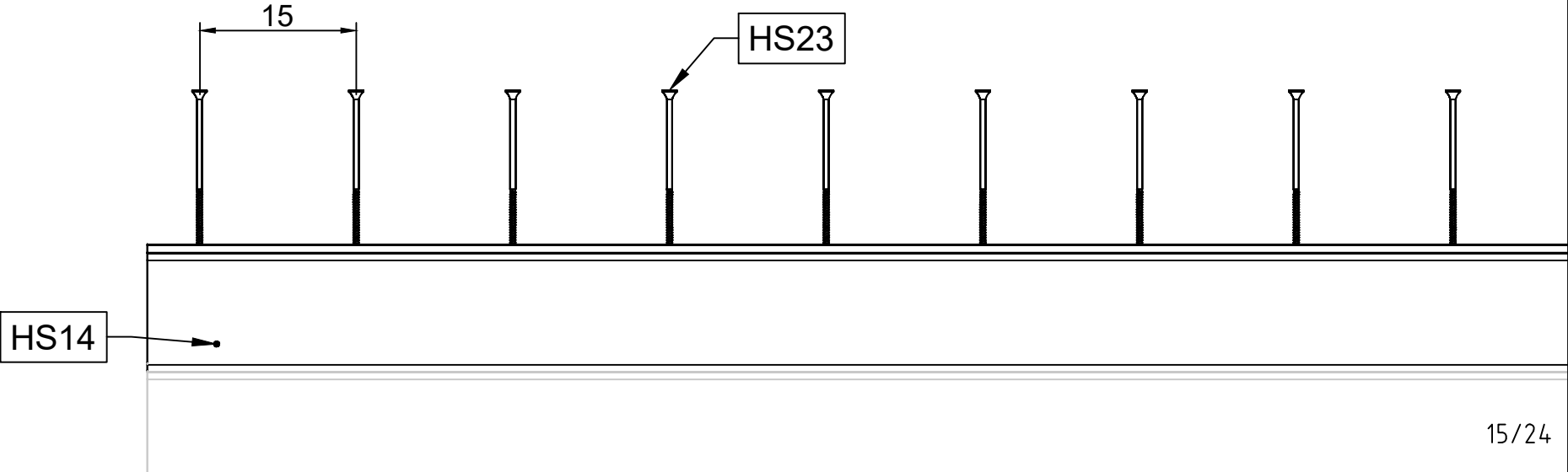

Art.Nr. WC165530

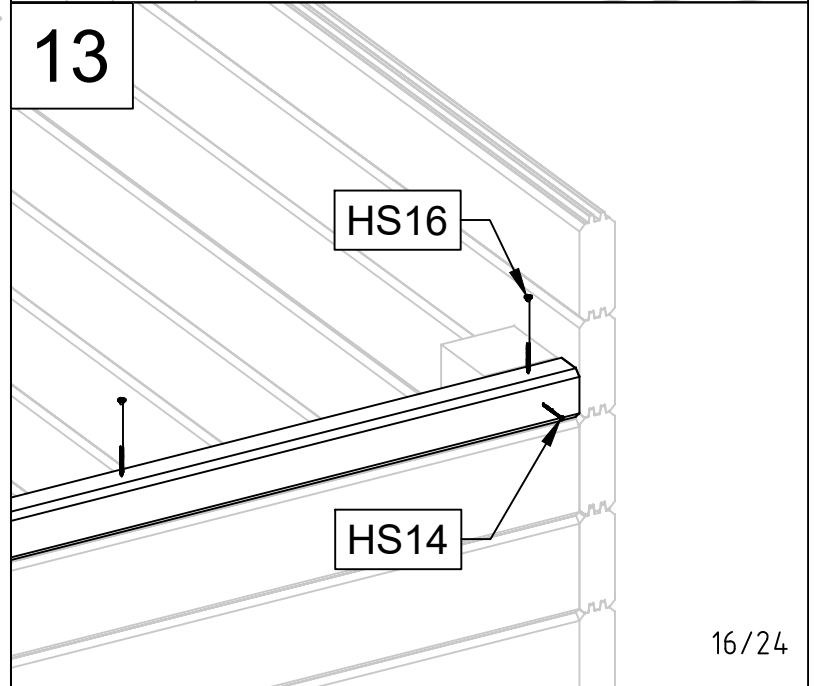
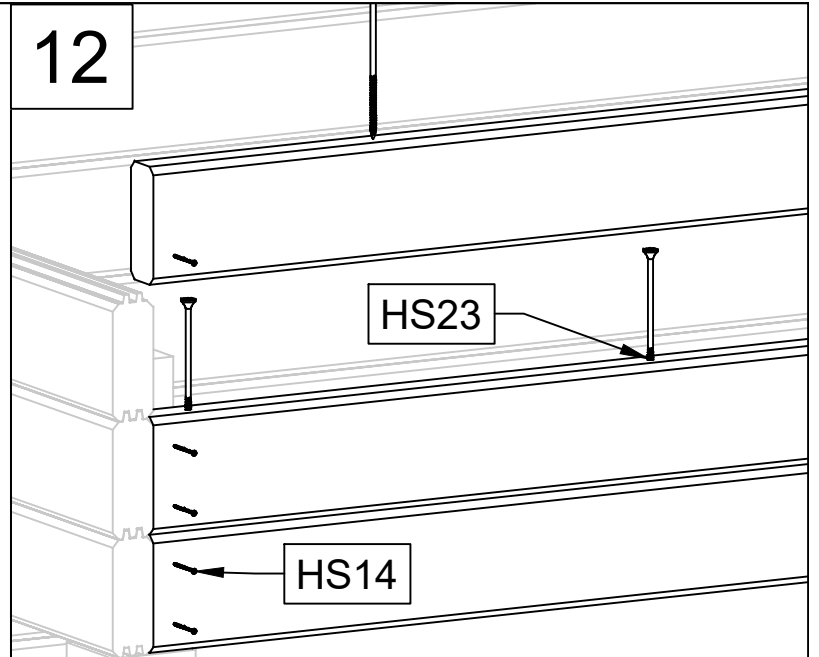
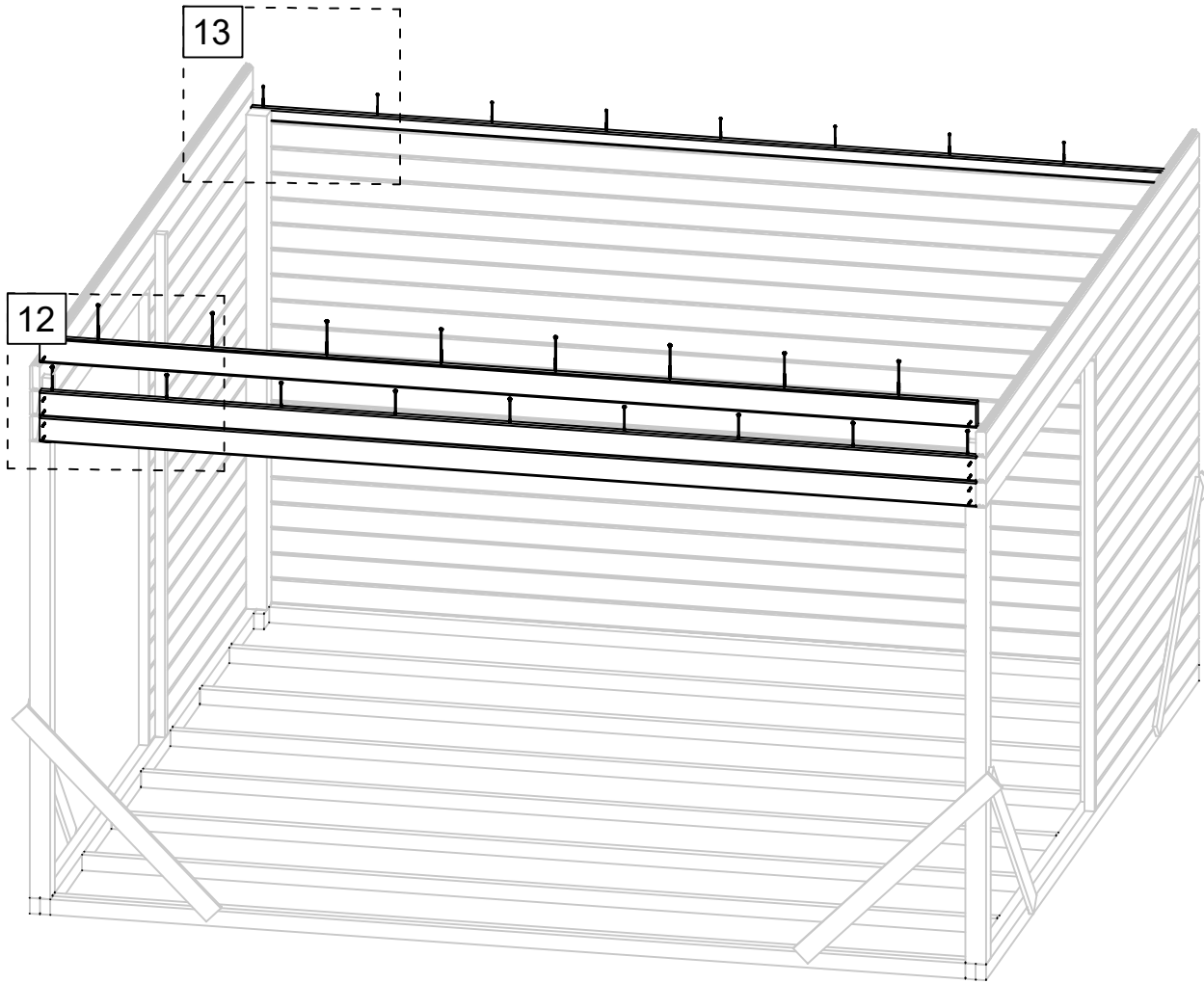

Art.Nr. WC165530

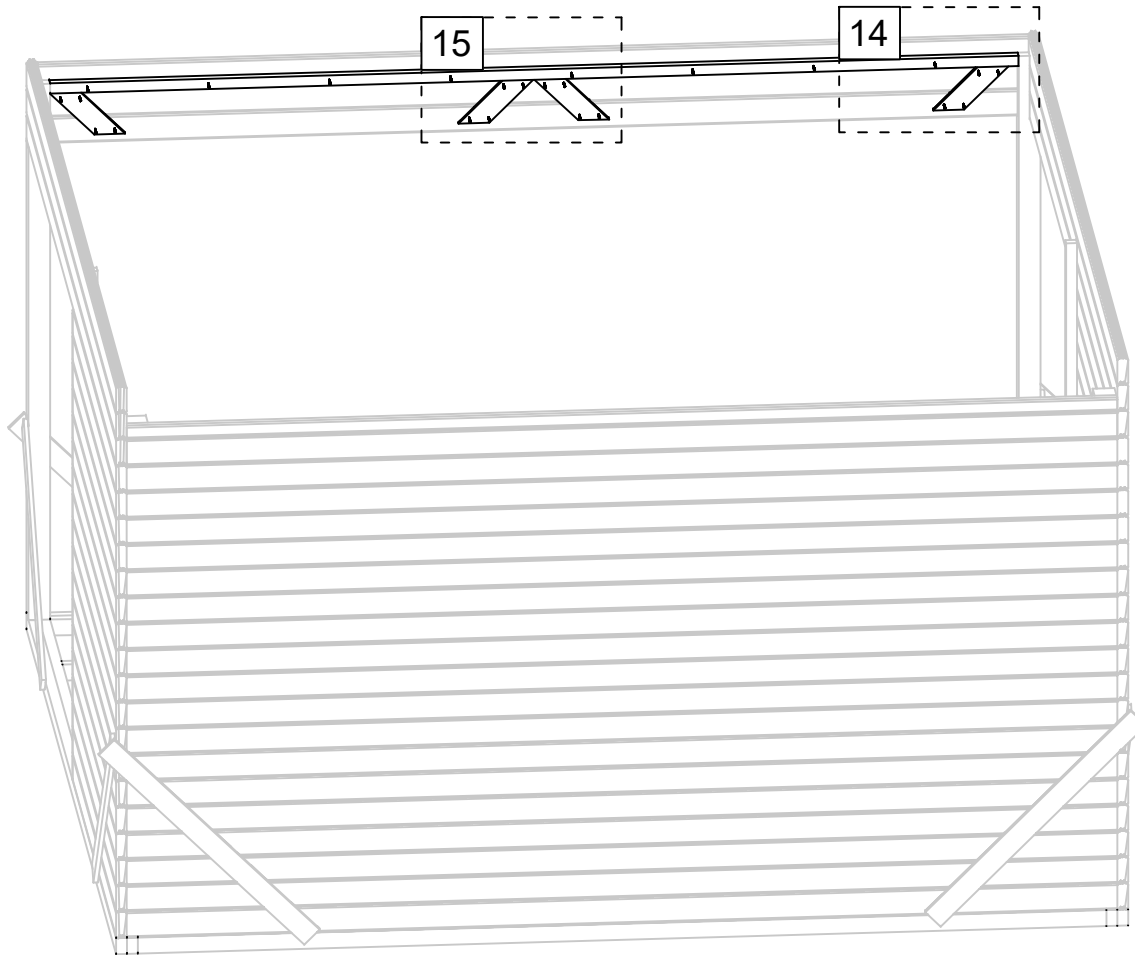

11.09.2019

14

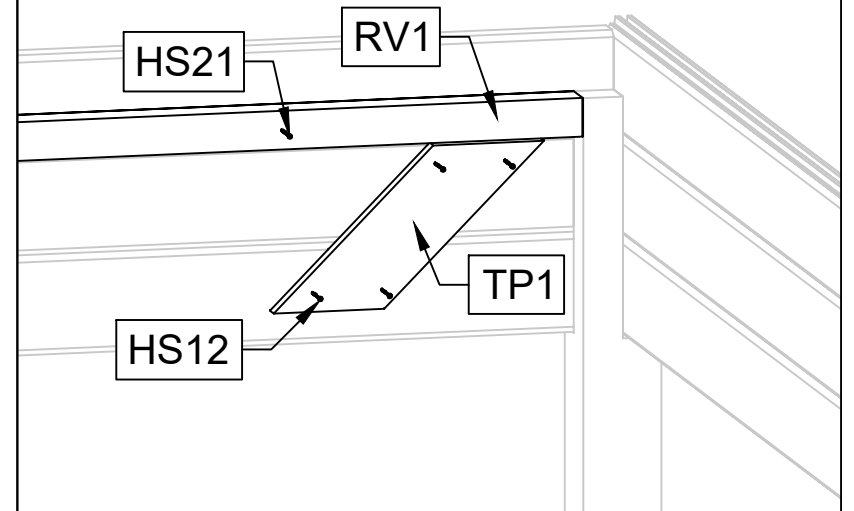

15

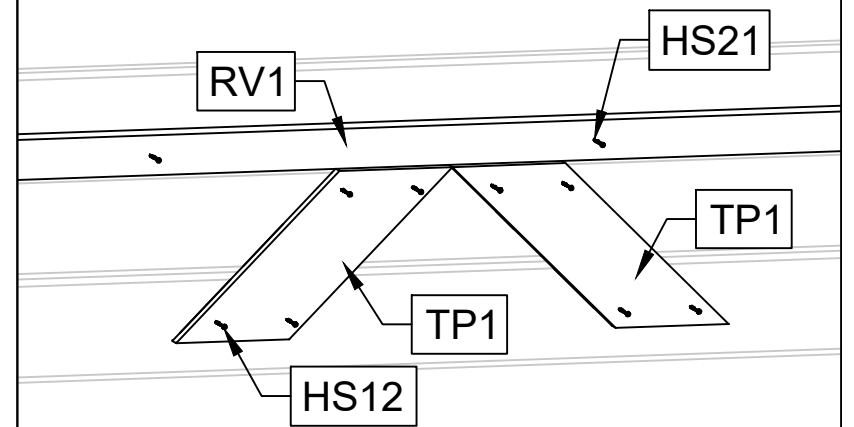

17/24

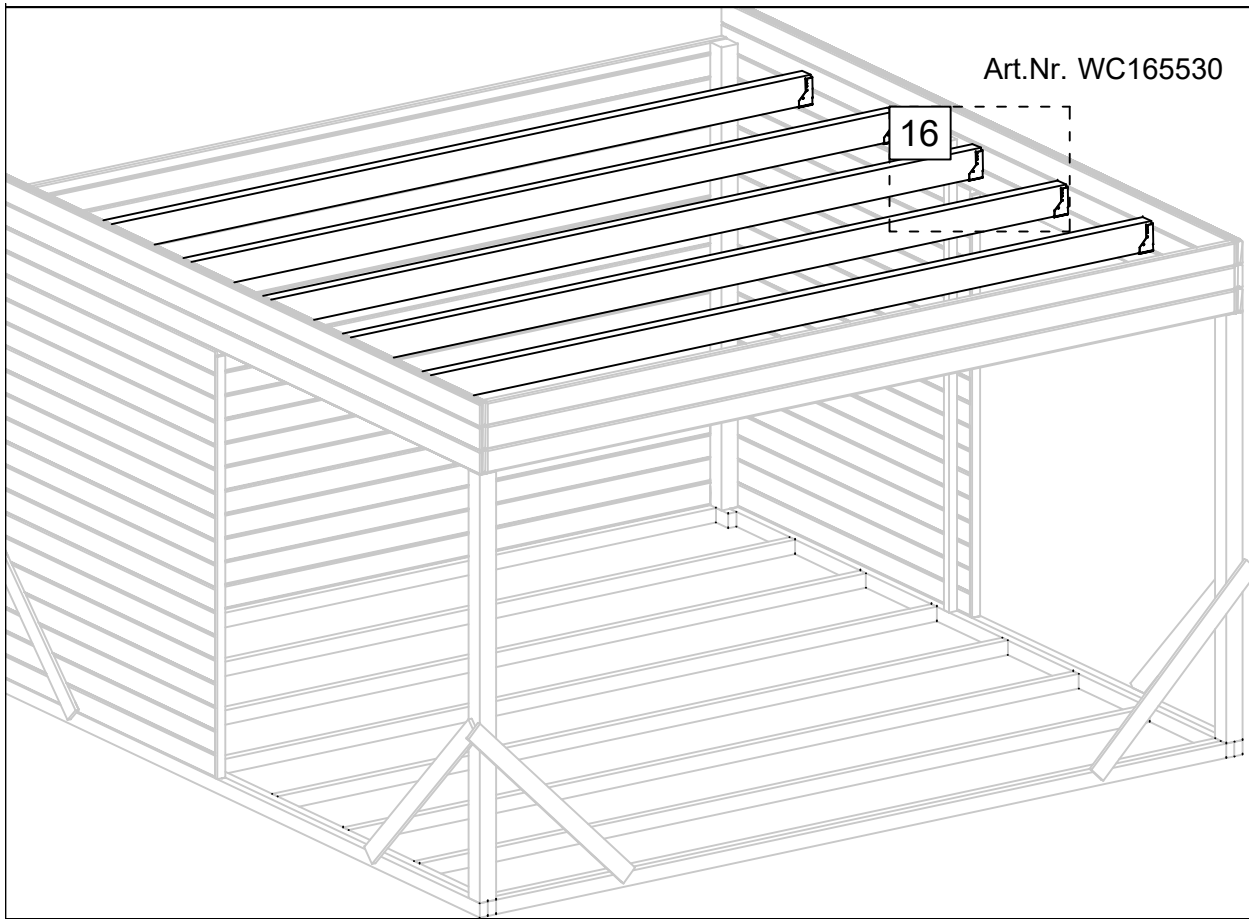

16

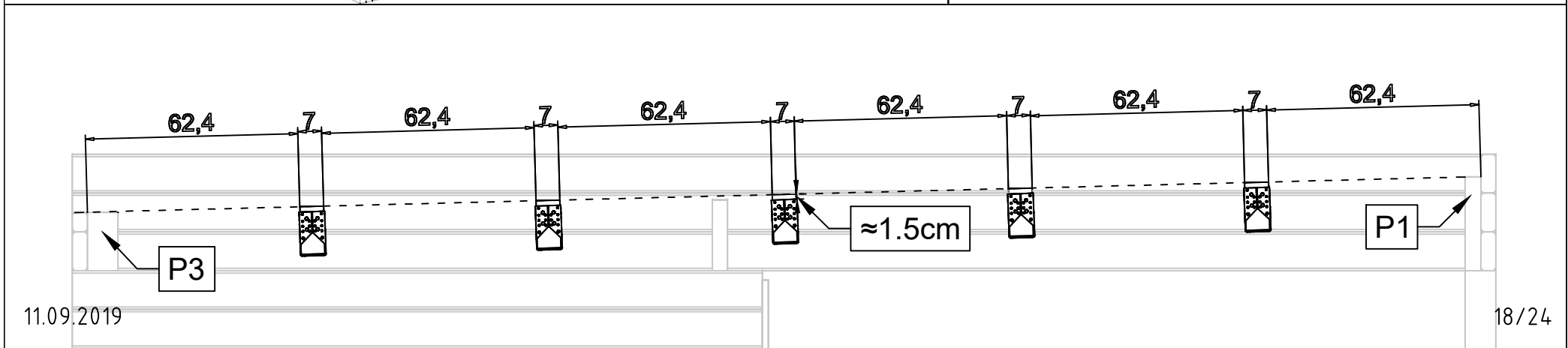
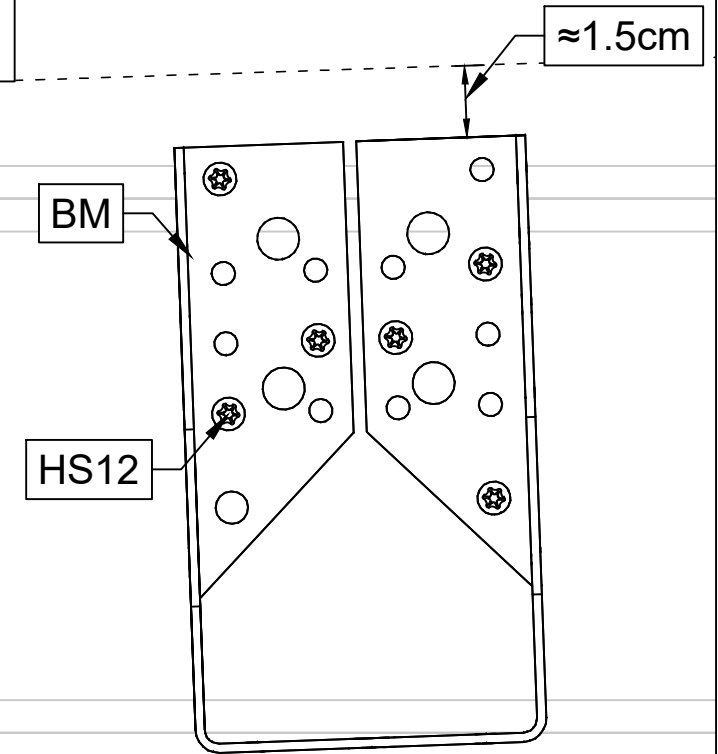

Art.Nr. WC165530

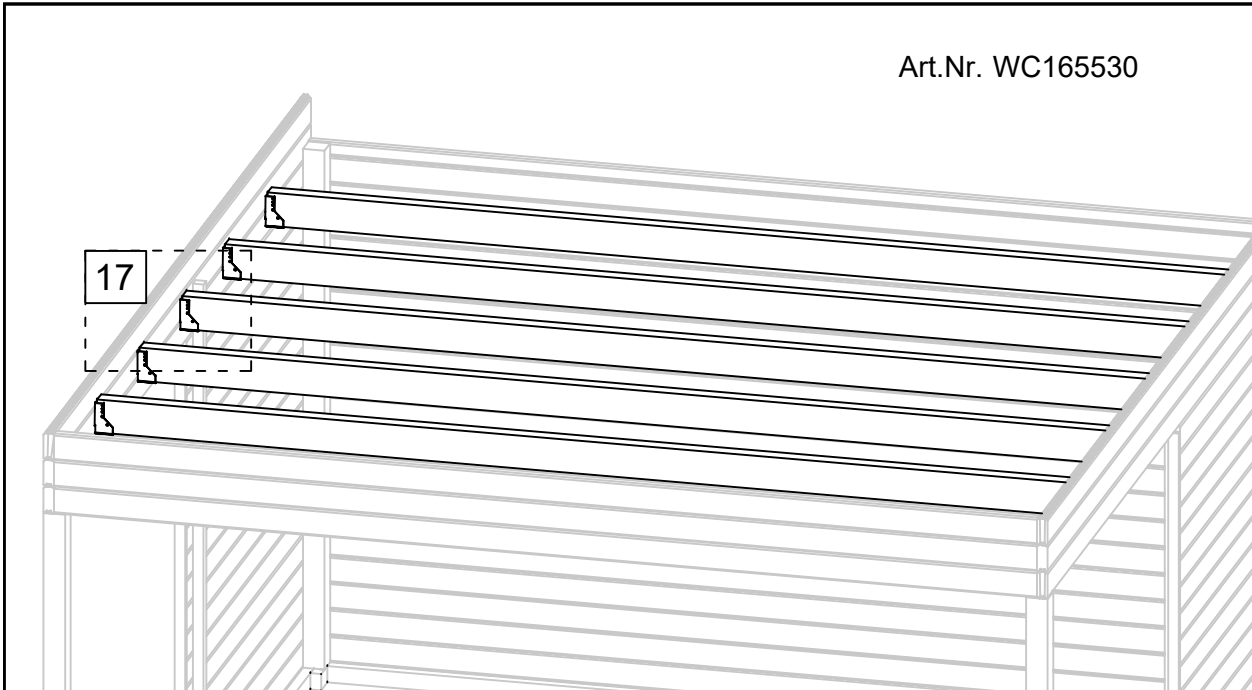

17

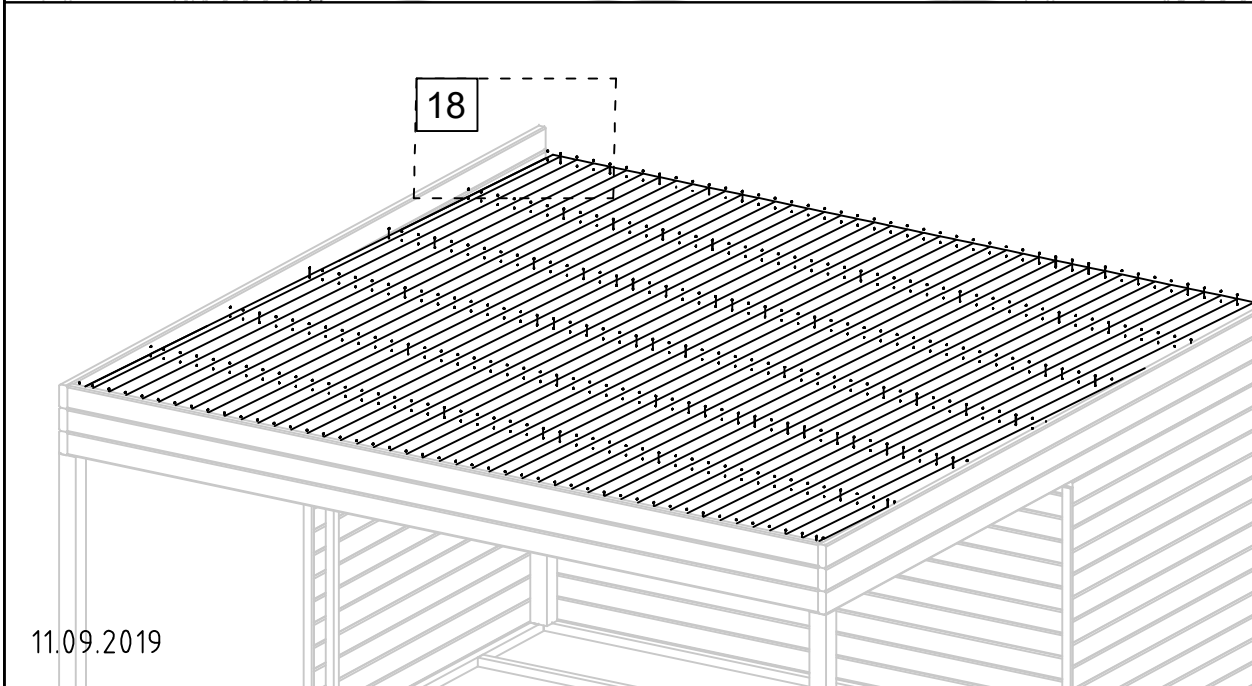
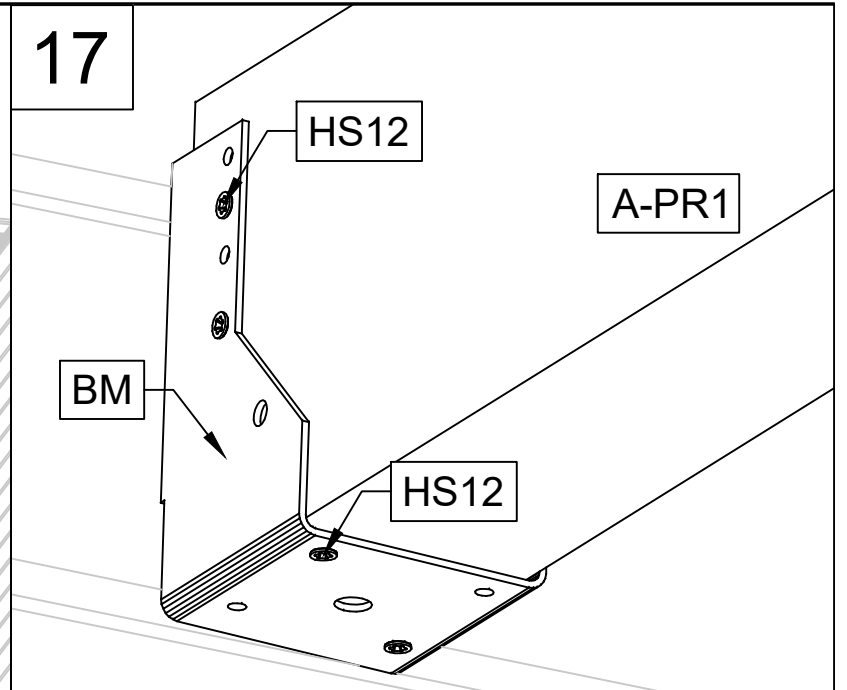

18

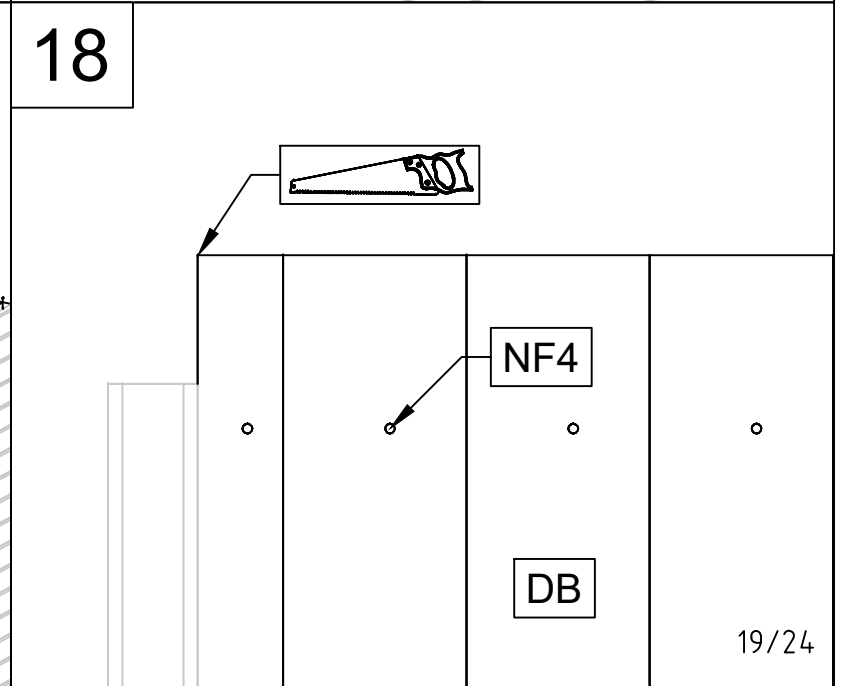

Art.Nr. WC165530

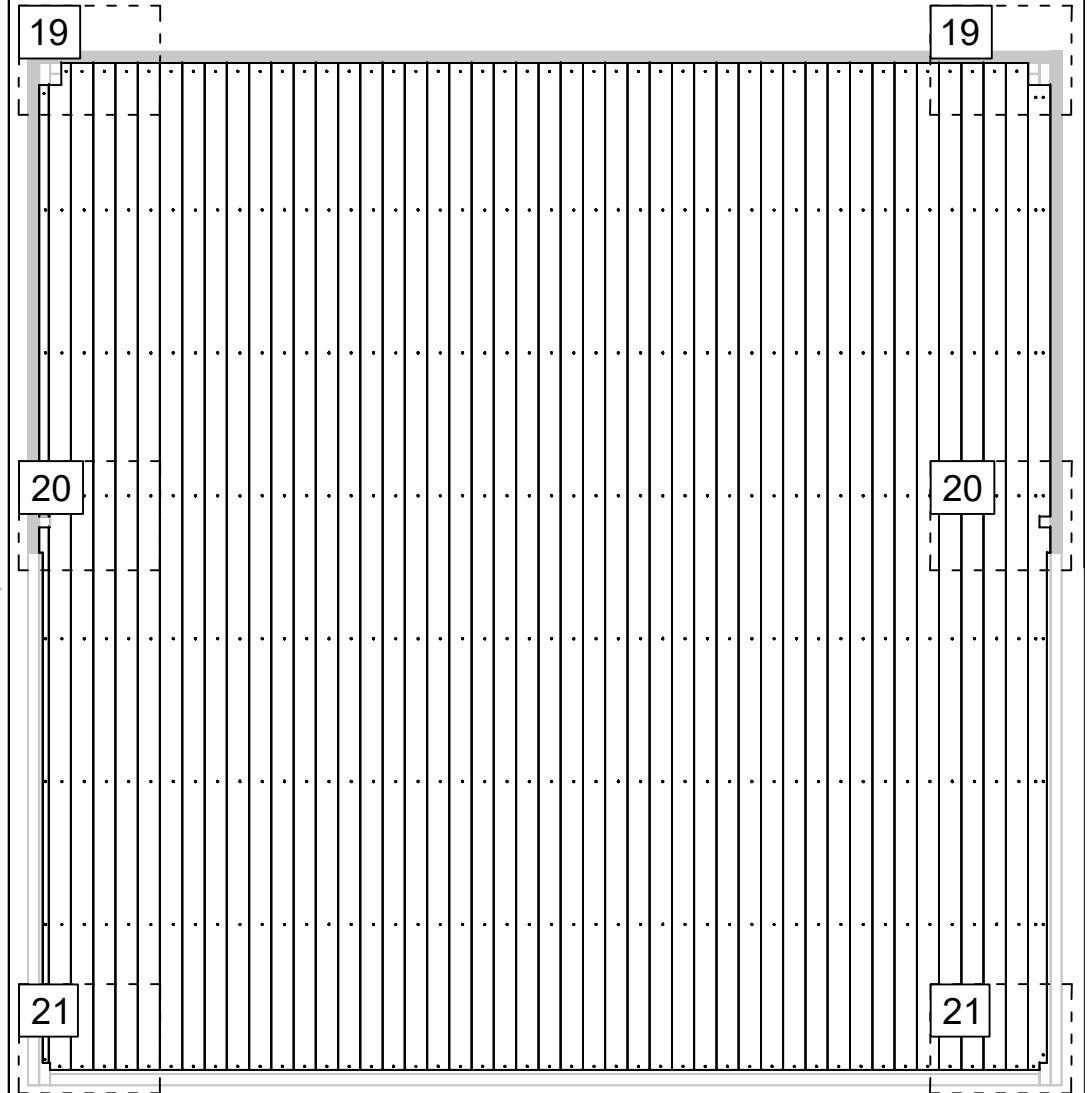
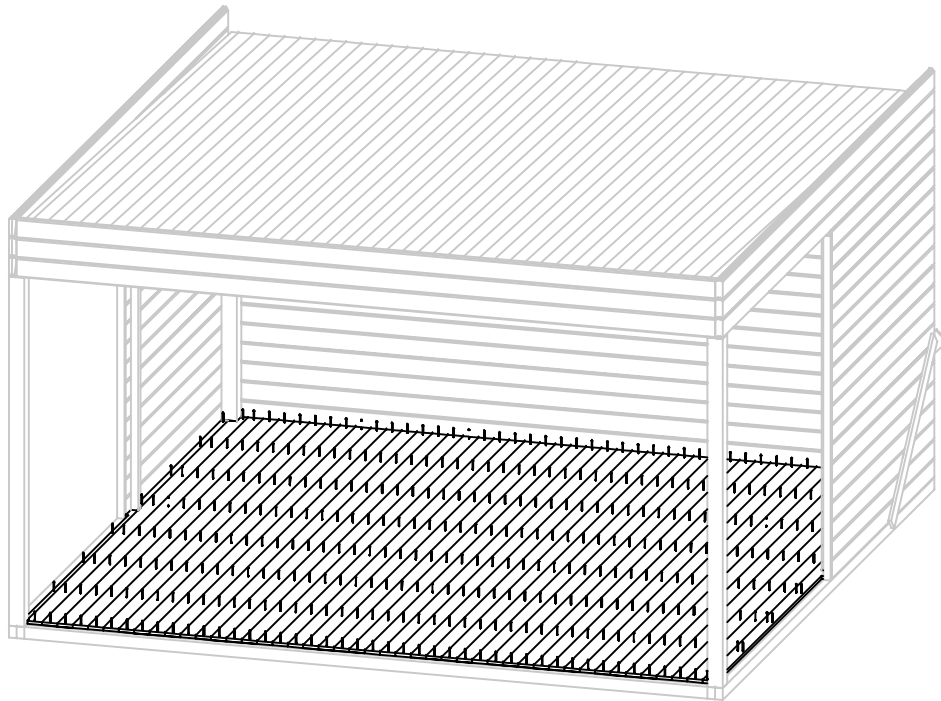

19

Art.Nr. WC165530

20

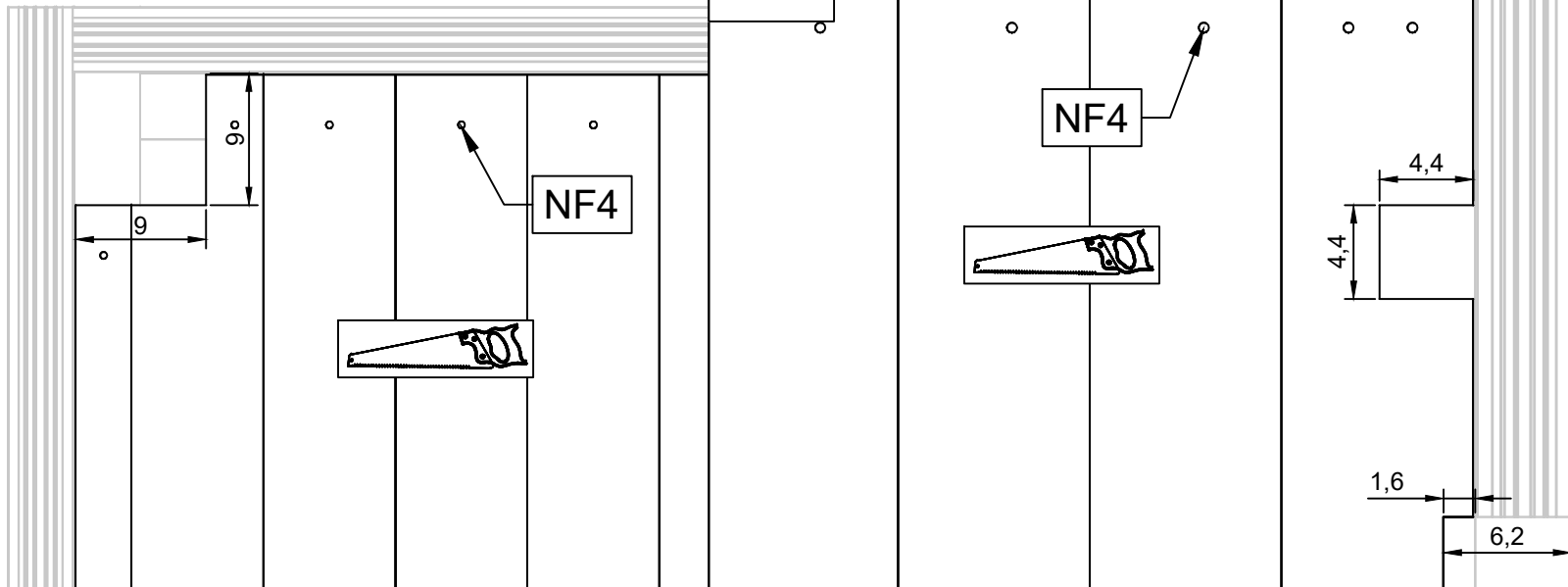

21

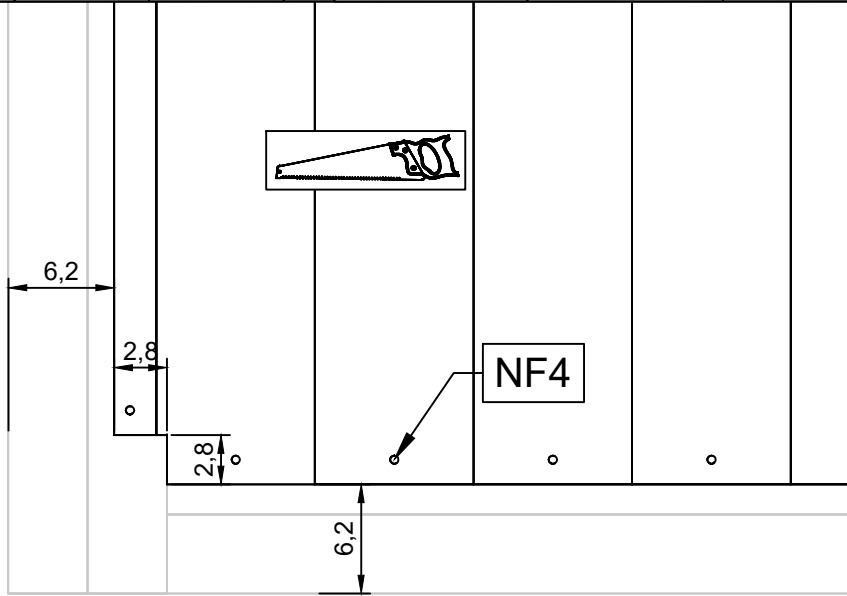

Art.Nr. WC165530

22

22

22

HS14

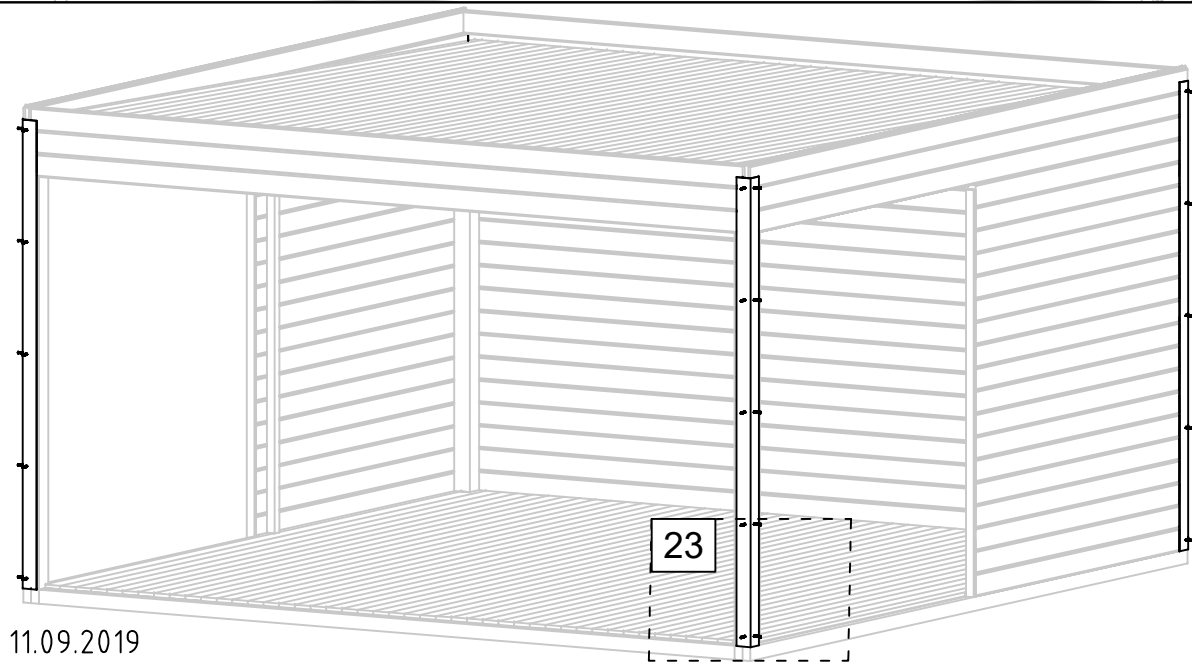

23

23

AL-1

HS29

11.09.2019

22/24

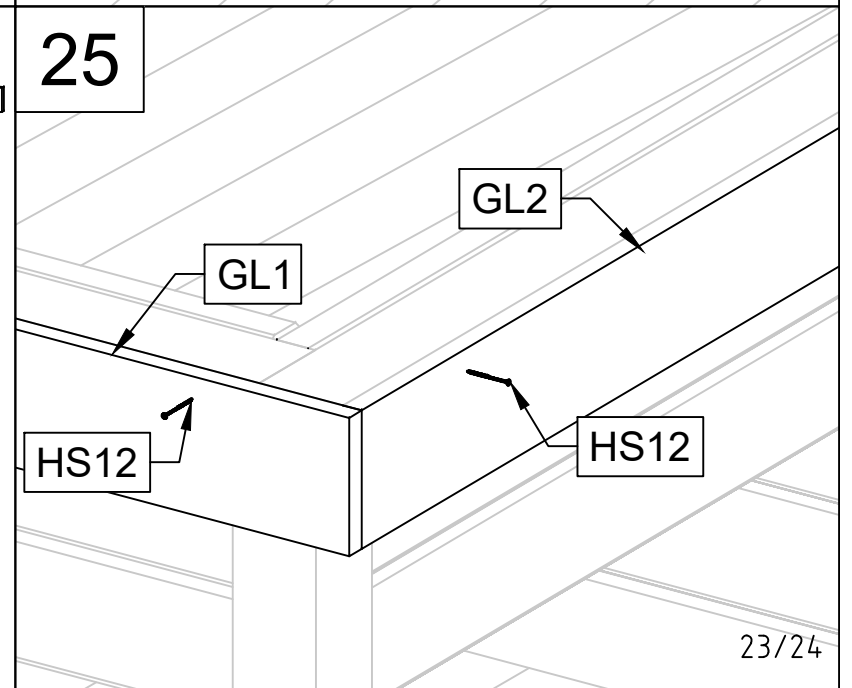
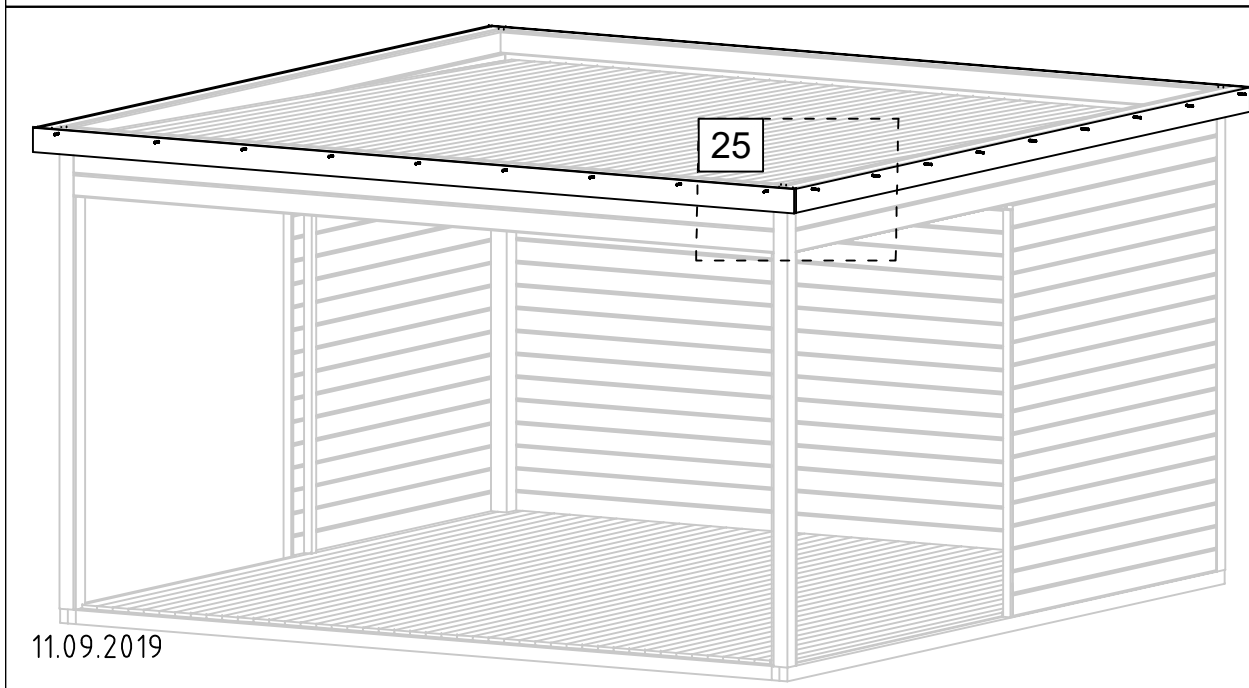
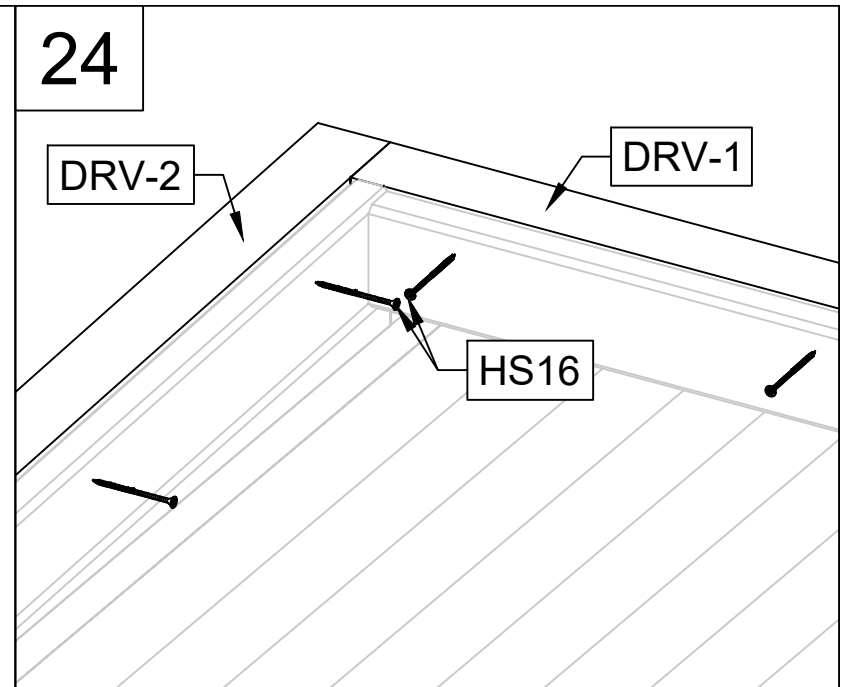
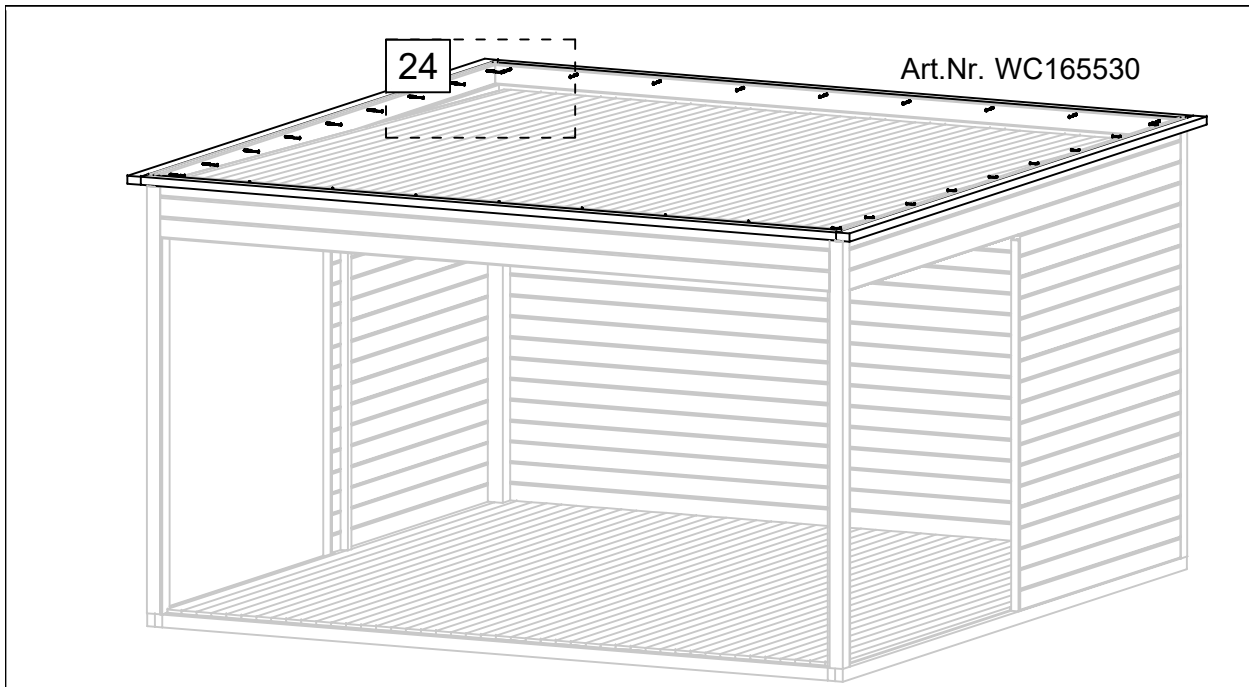

Art.Nr. WC165530

26

