

# MODULARO™

## WOODEN CABIN LUGANO

5.69 x 3.59 x 2.34 m



Art.Nr. WC165510

Groundplan - Grundplan - Plan de masse - Planimetria - Plattegrond - Põhiplaan

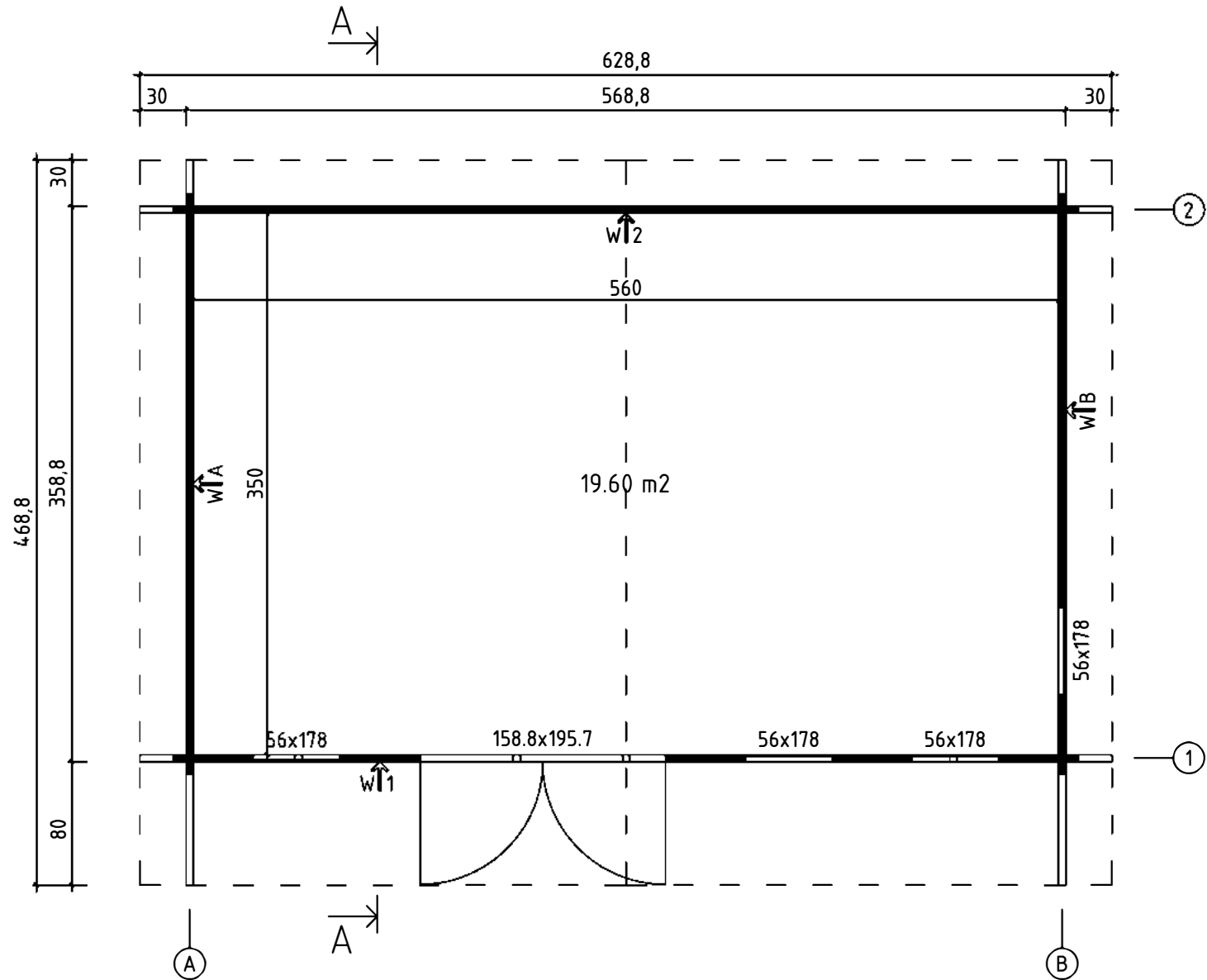

Foundation - Fundament - Fondation -  
Fondamenta - Fundering - Immutatud alusraam

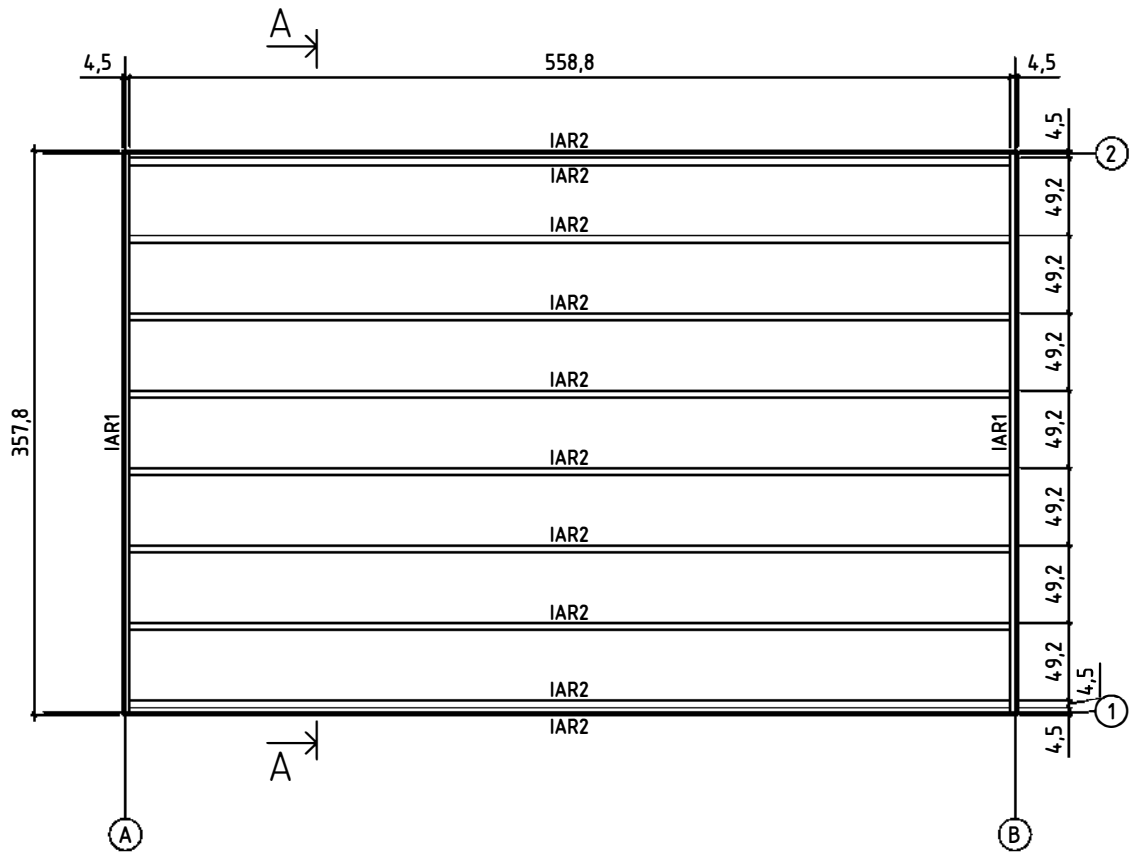

Floor boards - Fussbodenbretter - Plan pose plancher -  
Pavimento - Vloerhout - Põrandalaudis

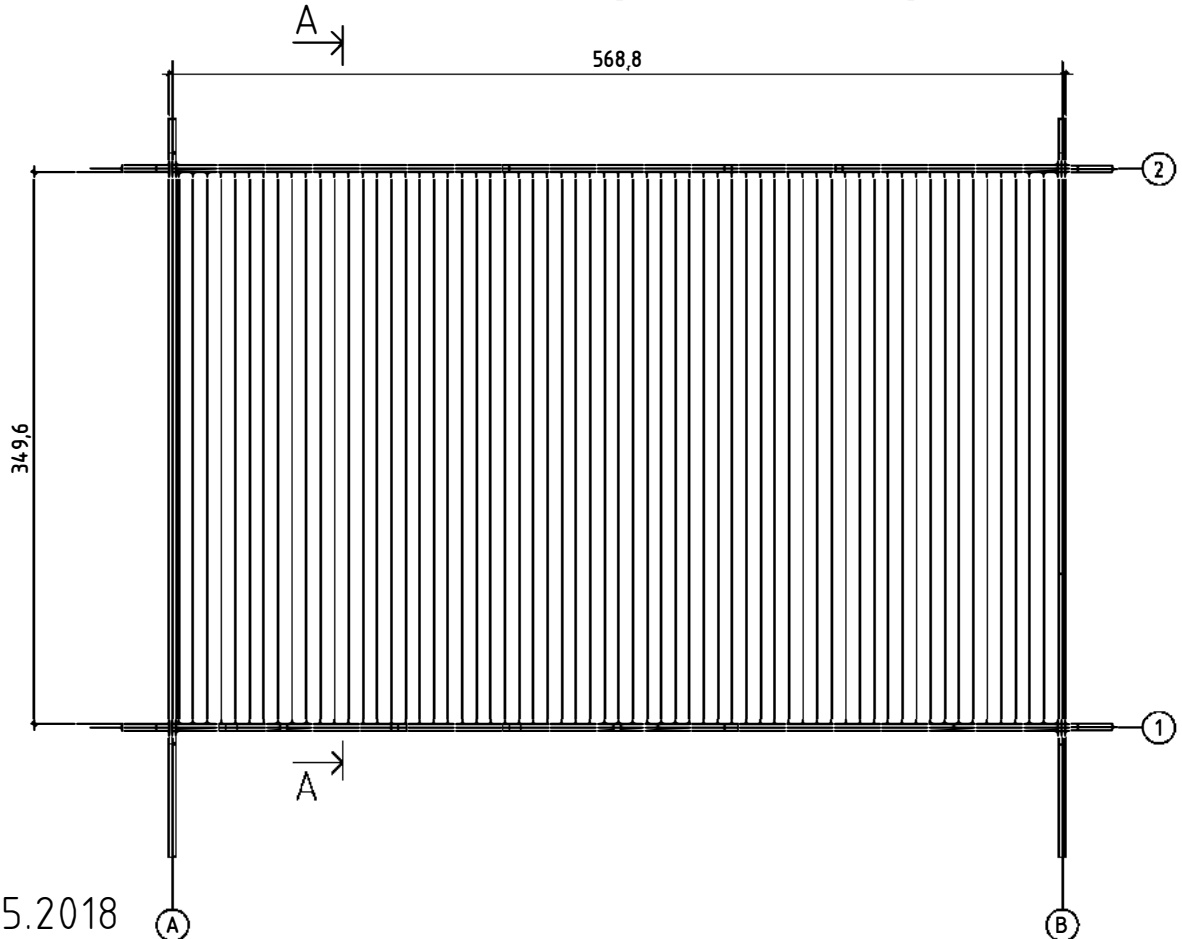



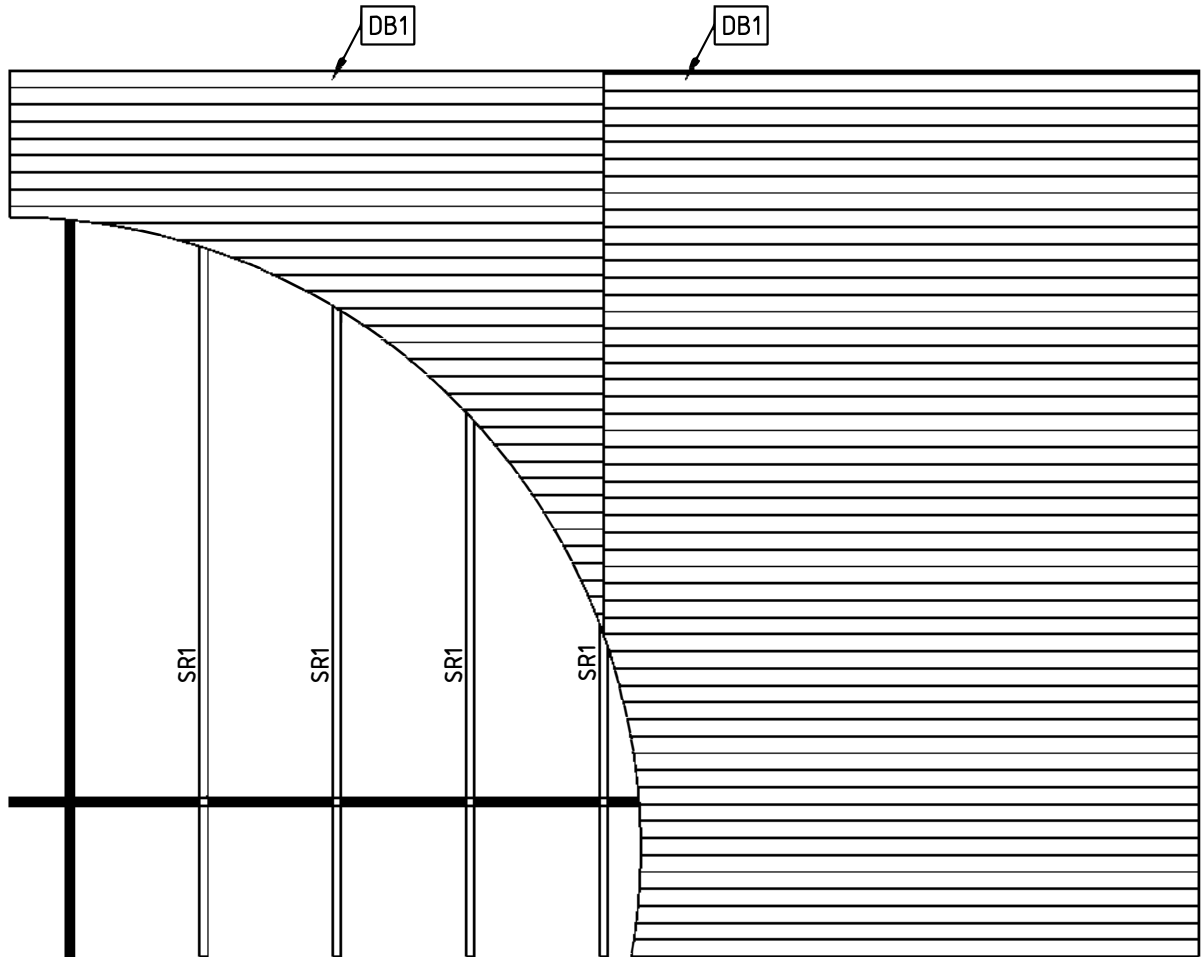

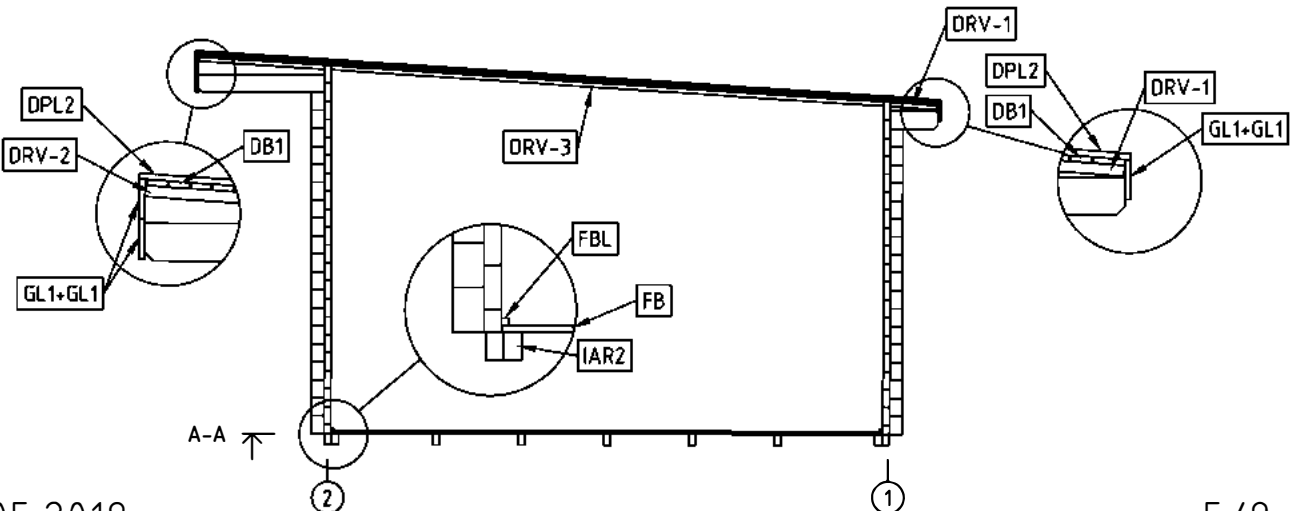
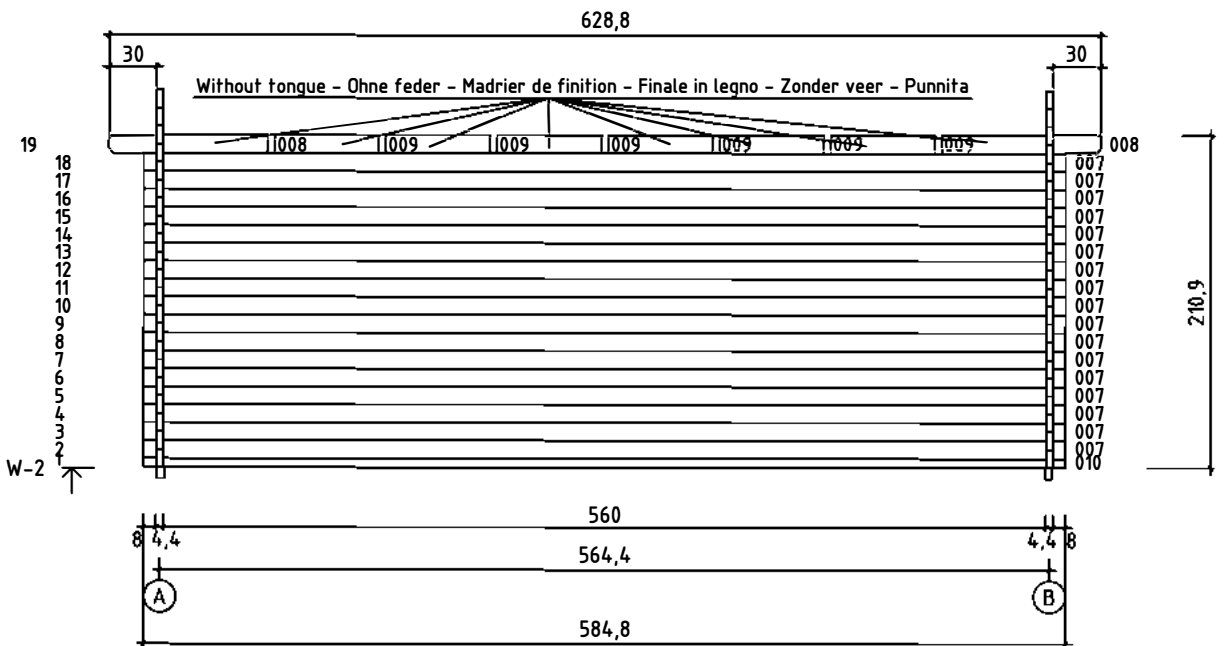
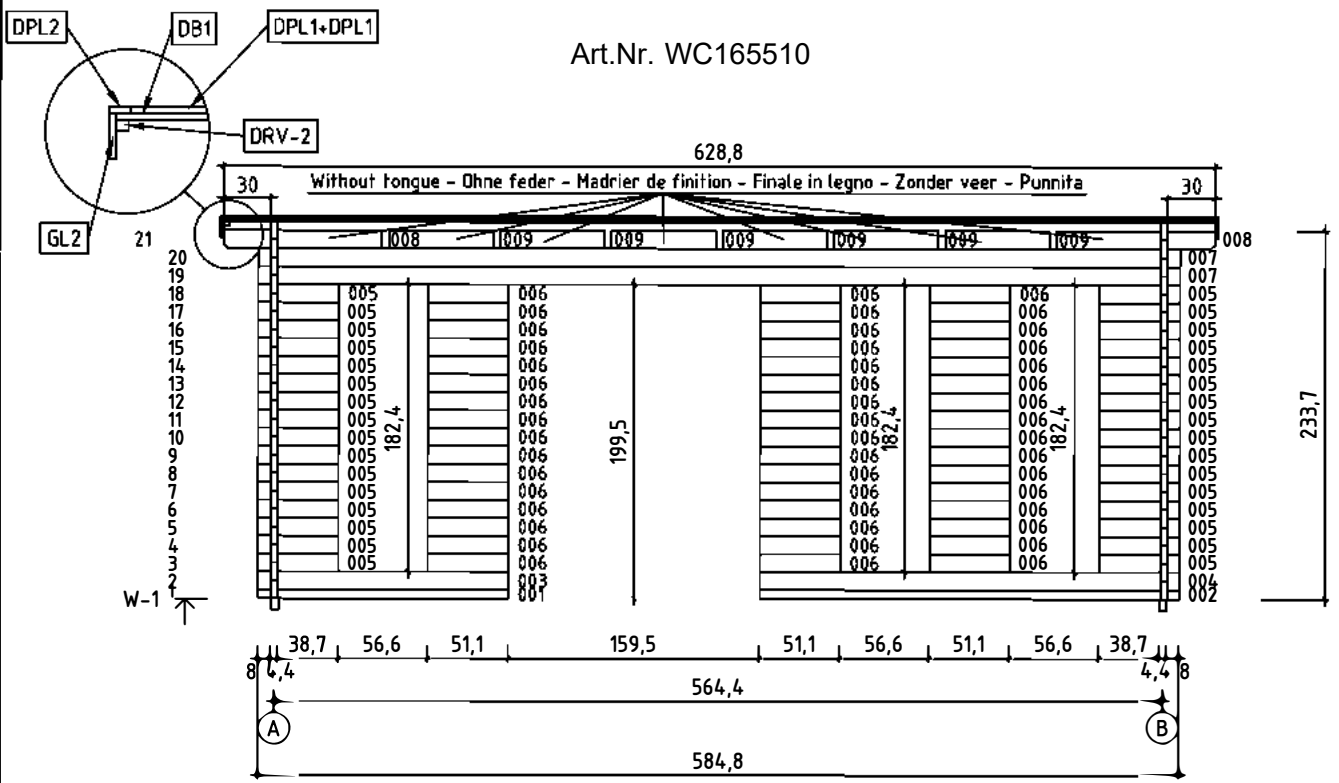

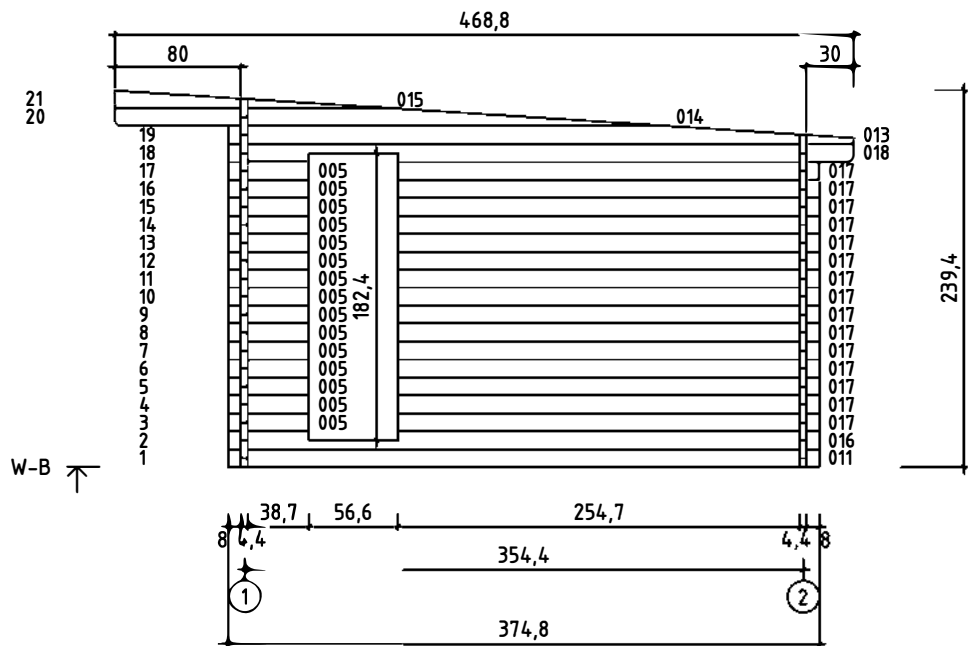
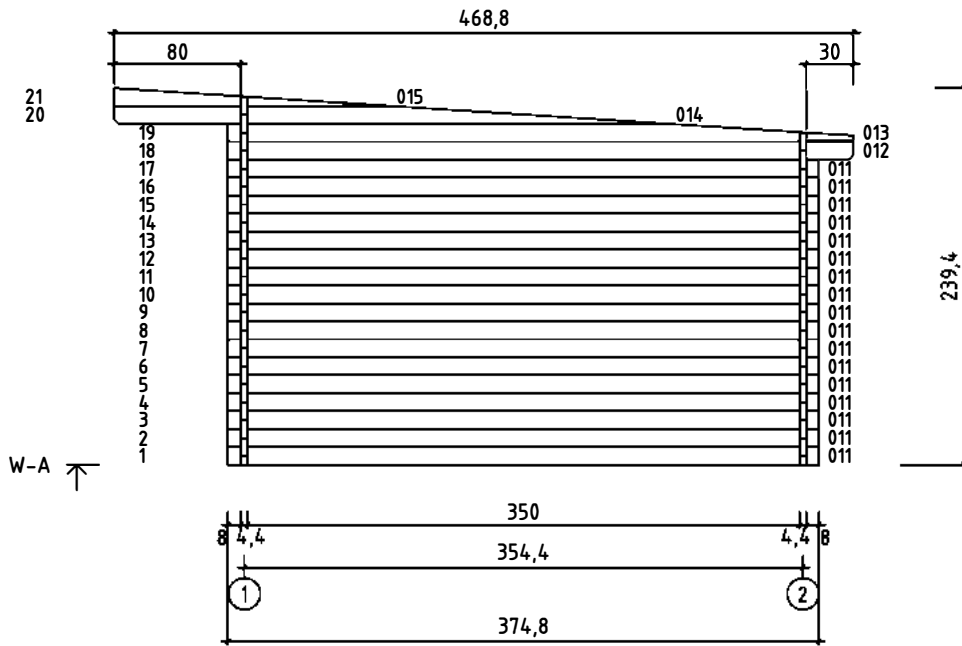

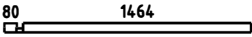
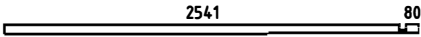
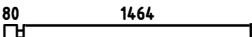
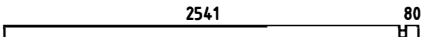

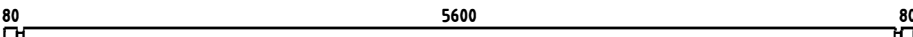
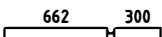
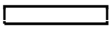
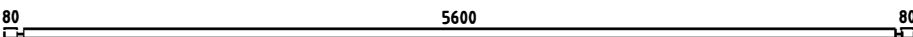
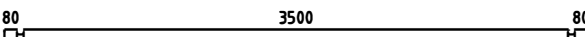
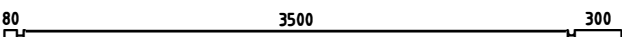
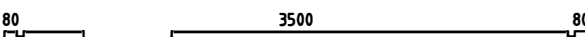
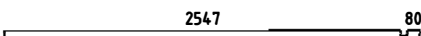
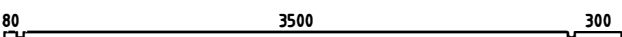
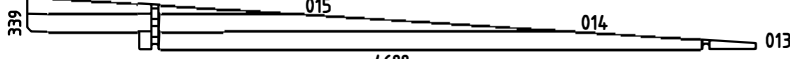
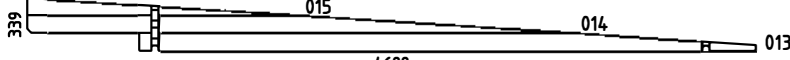
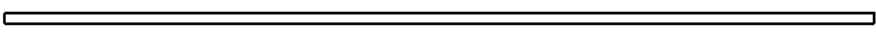
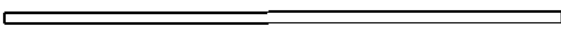
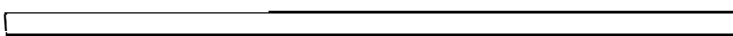

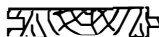











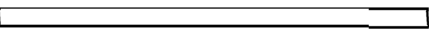

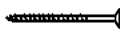
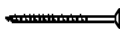
Rafters plan - Dachsparren - Plan de chevron - Piano di travi -  
Dak spar constructie plattegrond - Sarikaplaan





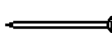

| Pos  | Piece list - Stückliste - Liste des pièces - Elementi - Stuklijst - Tükitalabel<br>09.05.2018 Art. Nr. WC165510                                                                                                                     | 7/9 | Q   | P<br>(mm) | L<br>(mm) |
|------|-------------------------------------------------------------------------------------------------------------------------------------------------------------------------------------------------------------------------------------|-----|-----|-----------|-----------|
| 001  |                                                                                                                                                    |     | 1   | 44x57     | 1588      |
| 002  |                                                                                                                                                    |     | 1   | 44x57     | 2665      |
| 003  |                                                                                                                                                    |     | 1   | 44x114    | 1588      |
| 004  |                                                                                                                                                    |     | 1   | 44x114    | 2665      |
| 005  |                                                                                                                                                    |     | 47  | 44x114    | 511       |
| 006  |                                                                                                                                                    |     | 48  | 44x114    | 511       |
| 007  |                                                                                                                                                   |     | 19  | 44x114    | 5848      |
| 008  |                                                                                                                                                    |     | 4   | 44x114    | 1006      |
| 009  |                                                                                                                                                    |     | 12  | 44x114    | 662       |
| 010  |                                                                                                                                                   |     | 1   | 44x57     | 5848      |
| 011  |                                                                                                                                                  |     | 18  | 44x114    | 3748      |
| 012  |                                                                                                                                                  |     | 1   | 44x114    | 3968      |
| 016  |                                                                                                                                                  |     | 1   | 44x114    | 3748      |
| 017  |                                                                                                                                                  |     | 15  | 44x114    | 2671      |
| 018  |                                                                                                                                                  |     | 1   | 44x114    | 3968      |
| WA-1 |                                                                                                                                                 |     | 1   |           |           |
| WB-1 |                                                                                                                                                 |     | 1   |           |           |
| IAR2 | Foundation - Fundament - Fondation - Fondamenta - Fundering - Immutatud alusraam<br>                                                            |     | 10  | 45x70     | 5588      |
| IAR1 | Foundation - Fundament - Fondation - Fondamenta - Fundering - Immutatud alusraam<br>                                                             |     | 2   | 45x70     | 3578      |
| SR1  | SARIKAD<br>                                                                                                                                     |     | 7   | 44x140    | 4698      |
| FB   | Floor boards - Fussbodenbretter - Lame de plancher - Pavimento - Vloerhout<br>- Põrandalaud                                                    |     | 63  | 90x18     | 3496      |
| DB1  | Roof boards - Dachbretter - Voliges - Perlina per tetto - Dakhout -<br>Katuselaud                                                              |     | 106 | 90x18     | 3144      |
| FBL  | Floor fillet - Fussbodenleiste - Corniere de finition du plancher - Finitura per<br>pavimento (battisco pa) - Vloerafwerklijst - Põrandaliist  |     |     | 18x18     | 18.18     |

| Pos   | Piece list - Stückliste - Liste des pièces - Elementi - Stuklijst - Tükítabel<br>09.05.2018<br>Art. Nr. WC165510                                                                                                                                                                                            | 8/9 | Q   | P<br>(mm) | L<br>(mm) |
|-------|-------------------------------------------------------------------------------------------------------------------------------------------------------------------------------------------------------------------------------------------------------------------------------------------------------------|-----|-----|-----------|-----------|
| DPL1  | Roofing felt fillet - Dachpappenleiste - Baguette de fixation du feutre bitumeux - Asse per fissaggio guaina bituminosa - Afdekljst asfaltpapier - Katusepapiilist                                                       |     | 2   | 18x58     | 3086      |
| DPL2  | Roofing felt fillet - Dachpappenleiste - Baguette de fixation du feutre bitumeux - Asse per fissaggio guaina bituminosa - Afdekljst asfaltpapier - Katusepapiilist                                                       |     | 2   | 18x58     | 4734      |
| DRV-1 | Roof edge reinforcement - Dachrandverstärkung - Corniere de renfort de bord de toit - Rinforzo x tetto - Dakrand versterking - Räästatugevdus                                                                            |     | 2   | 28x34     | 299       |
| DRV-2 | Roof edge reinforcement - Dachrandverstärkung - Corniere de renfort de bord de toit - Rinforzo x tetto - Dakrand versterking - Räästatugevdus                                                                            |     | 2   | 28x34     | 800       |
| DRV-3 | Roof edge reinforcement - Dachrandverstärkung - Corniere de renfort de bord de toit - Rinforzo x tetto - Dakrand versterking - Räästatugevdus                                                                            |     | 2   | 28x34     | 3505      |
| KFS-1 | Storm protection - Sturmleiste - Latte anti-tempete - Protezione anti vento - Stormverankering / beveiliging - Tormikinnitusliist                                                                                         |     | 2   | 22x45     | 2050      |
| KFS-2 | Storm protection - Sturmleiste - Latte anti-tempete - Protezione anti vento - Stormverankering / beveiliging - Tormikinnitusliist                                                                                         |     | 2   | 22x45     | 2500      |
| GL1   | Gable moulding - Giebelleiste - Planche de rive - Finitura per frontale e retro del tetto - Gevellijst - Viilulaud                                                                                                       |     | 6   | 18x120    | 3144      |
| GL2   | Gable moulding - Giebelleiste - Planche de rive - Finitura per frontale e retro del tetto - Gevellijst - Viilulaud                                                                                                        |     | 2   | 18x120    | 4705      |
| HS9   | Screw for gable moulding - Schrauben für giebelleiste - Vis pour fixation planche de rive - Vite per fissare finiture davanti e dietro del tetto - Schroef voor gevellijst - Kruvi viilulauale                          |     | 68  | 3.5x50    |           |
| HS12  | Screw for roof edge reinforcement - Schrauben für dachrandverstärkung - Vis pour fixation corniere renfort de bord de toit - Viti x rinforzo bordo tetto - Schroef voor dakrand versterking - Kruvi räästatugevdusele  |     | 26  | 4x40      |           |
| HS18  | Screw for rafter - Schrauben für dachsparren - Vis pour chevron - Vite per trave - Schroef voor dakspar - Kruvi sarikatele                                                                                             |     | 14  | 5x120     |           |
| HS18  | Screw for gable - Schrauben für giebel - Vis pour fixation des pignons - Viti per timpano - Schroef voor gevelpunt - Kruvi viilude kinnitamiseks                                                                       |     | 4   | 5x120     |           |
| HS16  | Screw for 1. wall beam - Schraube für 1. bohlenreihe - Vis de fixations 1ere rangée de madriers avec poutrelles de fondations - Vite fissaggio alle fondamenta - Schroef voor 1 wandbalk - Kruvi poollauale            |     | 10  | 5x90      |           |
| HS16  | Screw for foundation - Schrauben zur befestigung fundament - Vis de fixations des poutrelles de fondations - Viti x fondamenta - Schroef voor fundering - Kruvi alusraamile                                            |     | 20  | 5x90      |           |
| HS16  | Screw for foundation - Schrauben zur befestigung fundament - Vis de fixations des poutrelles de fondations - Viti x fondamenta - Schroef voor fundering - Kruvi alusraamile                                            |     | 10  | 5x90      |           |
| HS23  | Screw for pos. 008-009; - Schrauben für pos. 008-009 - Vis pour pos. 008-009 - Viti per fissare elemento vedi figura in pos. n.008-009 - Schroef voor pos. 008-009; - Kruvi pos. 008-009                               |     | 16  | 6x180     |           |
| NF2   | Zn nail for floor fillet - Zn nägel für fussbodenleiste - Pointe pour corniere de finition du plancher - Chiodi x fissaggio pavimento - Spijker(nagel) voor vloer afdekljst - Nael põrandaliistule                     |     | 36  | 1.4x40    |           |
| SH44  | Hammer block - Schlagholz - Calle de frappe - Blocco di legno da usare come cuscinetto quando si usa il martello - Slagklos - Löögiklots                                                                               |     | 1   |           |           |
| SFS   | Nut for storm protection - Schraubenmutter für sturmleiste - Ecrou pour latte anti-tempete - Dado x asta protezione vento - Moer voor stormverankering - Mutter tormikinnitusliistule                                  |     | 8   | D8        |           |
| NF4   | Zn nail for roof - Zn nägel für dachbretter - Pointe pour fixation voliges de toit - Chiodi x perline tetto - Spijker(nagel) voor dakhout - Nael katuselauale                                                          |     | 556 | 2x50      |           |
| NF4   | Zn nail for floor - Zn nägel für fussbodenbretter - Clous pour plancher - Chiodi x perline pavimento - Spijker(nagel) voor vloer - Nael põrandalauale                                                                  |     | 512 | 2x50      |           |
| NF5   | Zn nail for roofing felt fillet - Zn nägel für dachpappenleiste - Pointe pour baguette de fixation feutre bitumeux - Chiodi x carta bituminosa x tetto - Spijker(nagel) voor asfaltpapier afdekljst - Papiilistunael   |     | 34  | 2x40      |           |







|     |            |                                                                                                              |     |   |           |           |
|-----|------------|--------------------------------------------------------------------------------------------------------------|-----|---|-----------|-----------|
| Pos | 10.11.2017 | Piece list - Stückliste - Liste des pièces - Elementi - Stuklijst - Tükítabel<br>560x1780 AK.1.100.TPSP DGP+ | 1/1 | Q | P<br>(mm) | L<br>(mm) |
|-----|------------|--------------------------------------------------------------------------------------------------------------|-----|---|-----------|-----------|

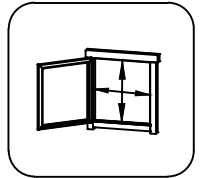
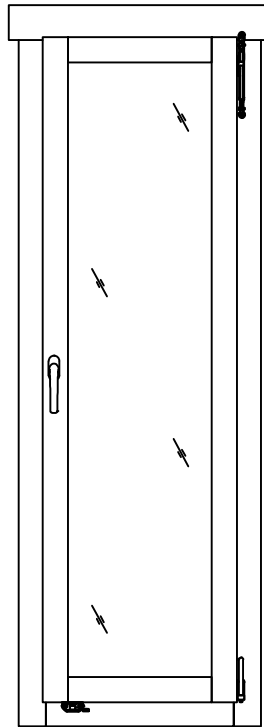



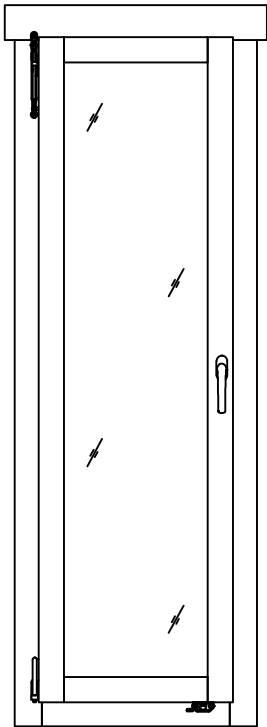
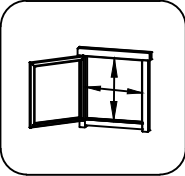

Glass size - Glasgröße - Taille de la vitre - Misura del vetro - Glas afmeting - Klaasi mõõt: 390x1602 mm

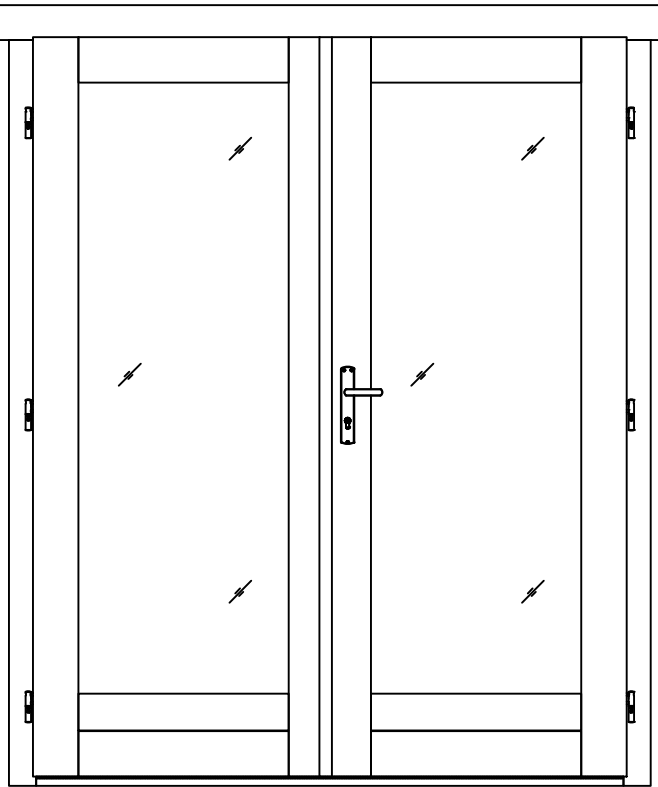
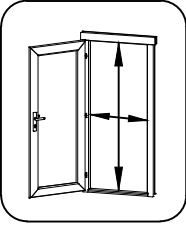
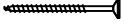
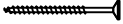
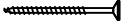

460x1684 mm

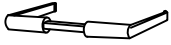
|     |                                                                                                                                 |                                                                                       |   |  |  |
|-----|---------------------------------------------------------------------------------------------------------------------------------|---------------------------------------------------------------------------------------|---|--|--|
| FS2 | Window handle fittings - Fenstergriff - Poignée de fenetre - Maniglia<br>c/ferramenta - Raamhendel -/grendel -/klink - Aknalink |  | 1 |  |  |
|-----|---------------------------------------------------------------------------------------------------------------------------------|---------------------------------------------------------------------------------------|---|--|--|

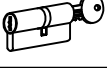
| Pos | 10.11.2017 Piece list - Stückliste - Liste des pièces - Elementi - Stuklijst - Tükitalabel<br>560x1780 AK.1.100.TPSV DGP+                                                                                                                                                                                                                                            | 1/1                                                                                   | Q | P<br>(mm) | L<br>(mm) |
|-----|----------------------------------------------------------------------------------------------------------------------------------------------------------------------------------------------------------------------------------------------------------------------------------------------------------------------------------------------------------------------|---------------------------------------------------------------------------------------|---|-----------|-----------|
|     | <p data-bbox="256 152 1289 183">Glass size - Glasgröße - Taille de la vitre - Misura del vetro - Glas afmeting - Klaasi mõõt: 390x1602 mm</p>   <p data-bbox="1362 349 1497 380">460x1684 mm</p> |                                                                                       |   |           |           |
| FS2 | <p data-bbox="261 2130 1023 2186">Window handle fittings - Fenstergriff - Poignee de fenetre - Maniglia<br/>c/ferramenta - Raamhendel -/grendel -/klink - Aknalink</p>                                                                                                                                                                                               |  | 1 |           |           |

| Pos  | Piece list - Stückliste - Liste des pièces - Elementi - Stuklijst - Tükitalabel<br>1588x1957 TUK.1.100.TPVP.MM DGP+                                                                                                                                                                                          | 1/1                                                                                   | Q  | P<br>(mm) | L<br>(mm) |
|------|--------------------------------------------------------------------------------------------------------------------------------------------------------------------------------------------------------------------------------------------------------------------------------------------------------------|---------------------------------------------------------------------------------------|----|-----------|-----------|
|      | <p>Glass size - Glasgröße - Taille de la vitre - Misura del vetro - Glas afmeting - Klaasi mõõt: 561x1593 mm</p>   <p>1488x1873 mm</p> |                                                                                       |    |           |           |
| HS4  | Screw for door fillet - Schraube zur Befestigung türleiste - Vis pour fixation baguette d'arret de porte - Viti per massellino della porta - Schroef voor deurlijst - Kruvi ukse kokkuvaltšiliistule                                                                                                         |  | 5  | 3x30      |           |
| HS16 | Screw for door jamb - Schraube für Türrahmen - Vis de fixation partie haute avec montants du cadre de porte - Viti x fissaggio montanti porte - Schroef voor deurkozijn - Kruvi ukse lengile                                                                                                                 |  | 4  | 5x90      |           |
| HS25 | Screw for doorstep - Schrauben für swelle - Vis pour fixation barre de seuil - Vite per soglia della porta - Schroef voor deurdorpel - Kruvi lävepakule                                                                                                                                                      |  | 3  | 4.5x65    |           |
| MH   | Male bolt hinge for door - Türband - Partie male de paumelle de porte - Cerniera anube x porta - Scharnier bout - Reguleeritav polthing isane                                                                                                                                                                |  | 6  | 14x80     |           |
| HC   | Covers for door hinges - Schutzkappe für Türband - Couverture de paumelle de porte - Copertura delle cerniere della porta - Afdek kap voor deurscharnier - Reguleeritava polthinge kate                                                                                                                      |  | 12 |           |           |
| TL4  | Door handle fittings - Türgriff - Poignée de porte - Maniglie - Deurhendel / klink - Ukse käepide                                                                                                                                                                                                            |  | 1  |           |           |
| TL5  | Set of door lock covers - Schlossblenden - Set de garnitures de porte - Copertura serrature - Slot sluitplaat set - Ukse lukuplaat                                                                                                                                                                           |  | 1  |           |           |
|      | Cylinder lock - Zylinderschloss - Barillet de porte - Serratura - Cylinder slot - Ukse lukusüdamik                                                                                                                                                                                                           |  | 1  | 30x35     |           |
|      | Striker for barrel bolt - Hülse für Grendelriegel - Gache au sol du targette - Boccola per fermo della porta - Huls voor vergrendelingsschuif - Vasturaud ukse servariivile                                                                                                                                  |  | 2  |           |           |