

MODULARO™

WOODEN SHED LYON

2 x 2 x 2.34 m



Groundplan - Grundplan - Plan de masse - Planimetria - Plattegrond - Põhiplaan

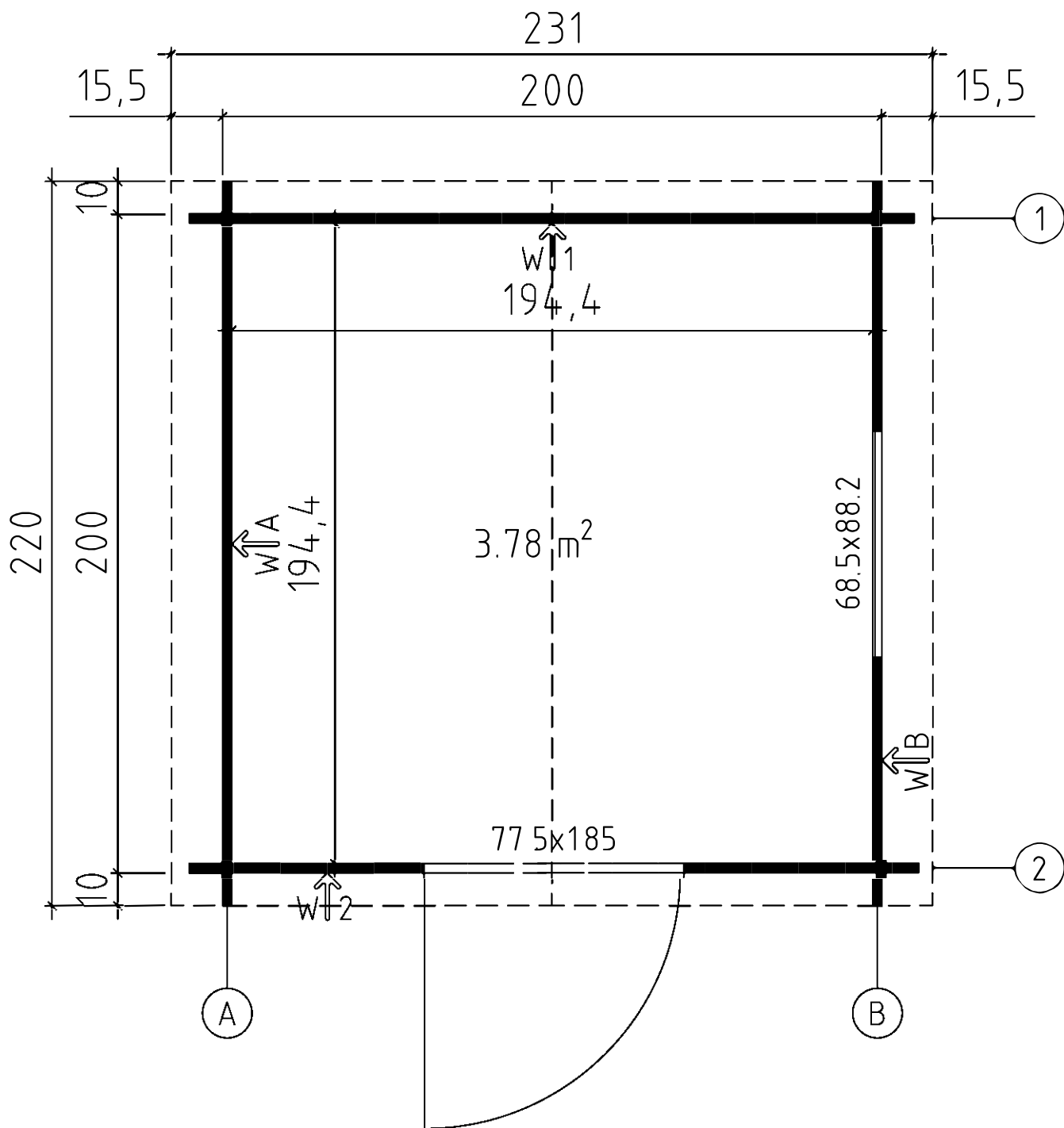

Foundation - Fundament - Fondation - Fundamenta - Fundering - Immutatud alusraam

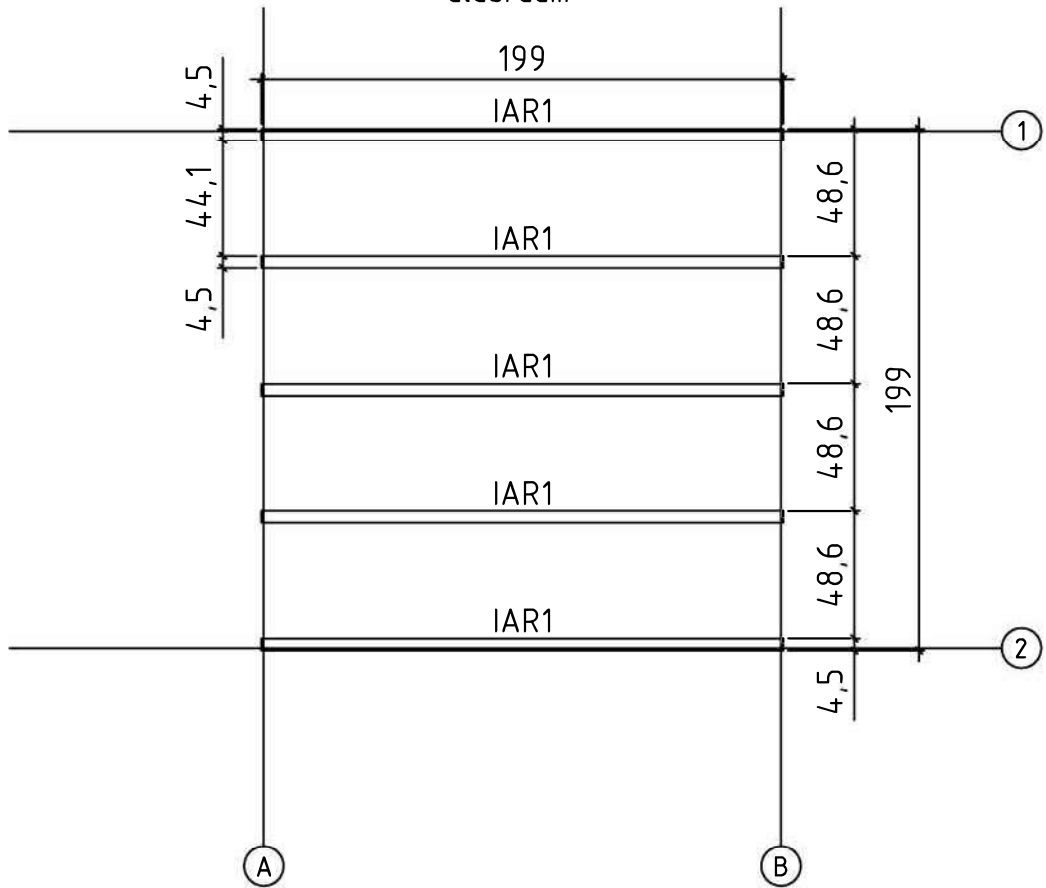



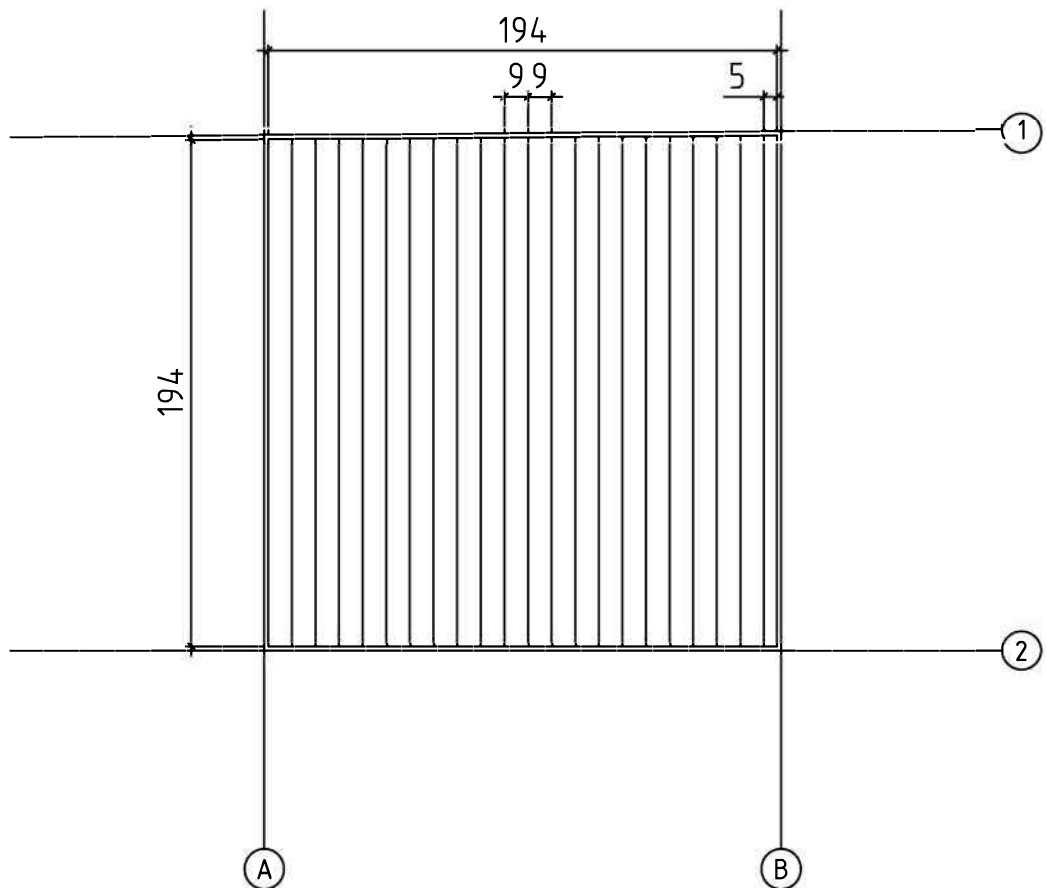

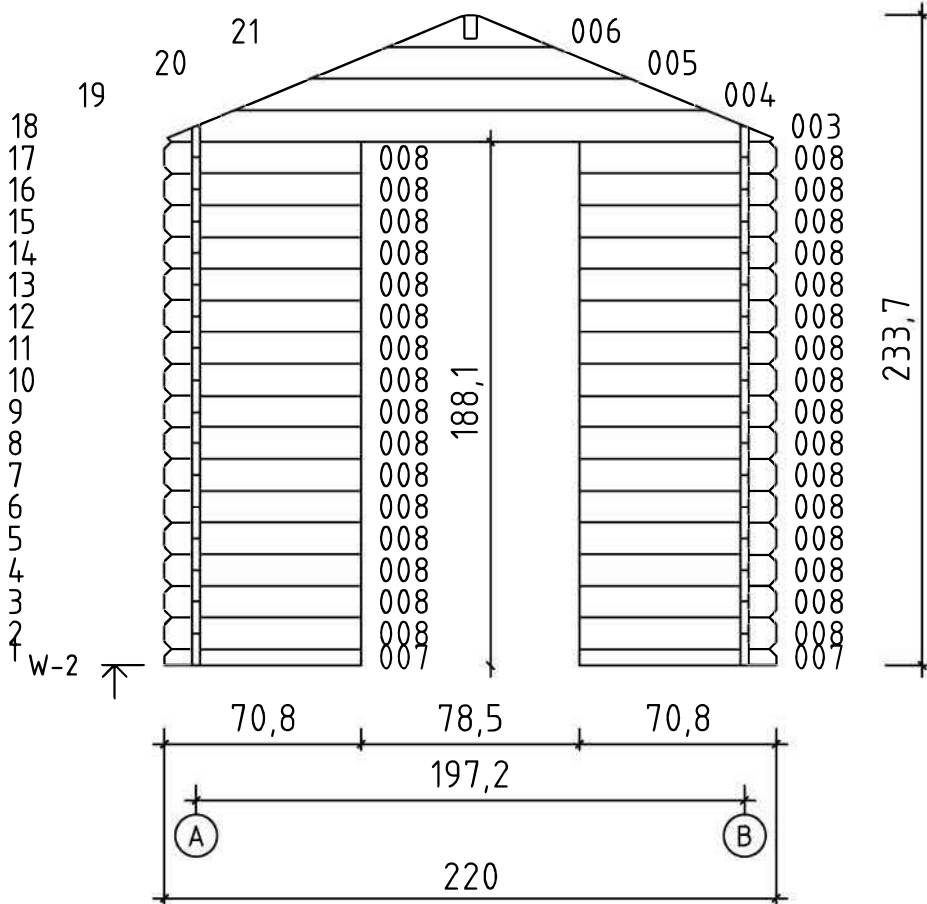
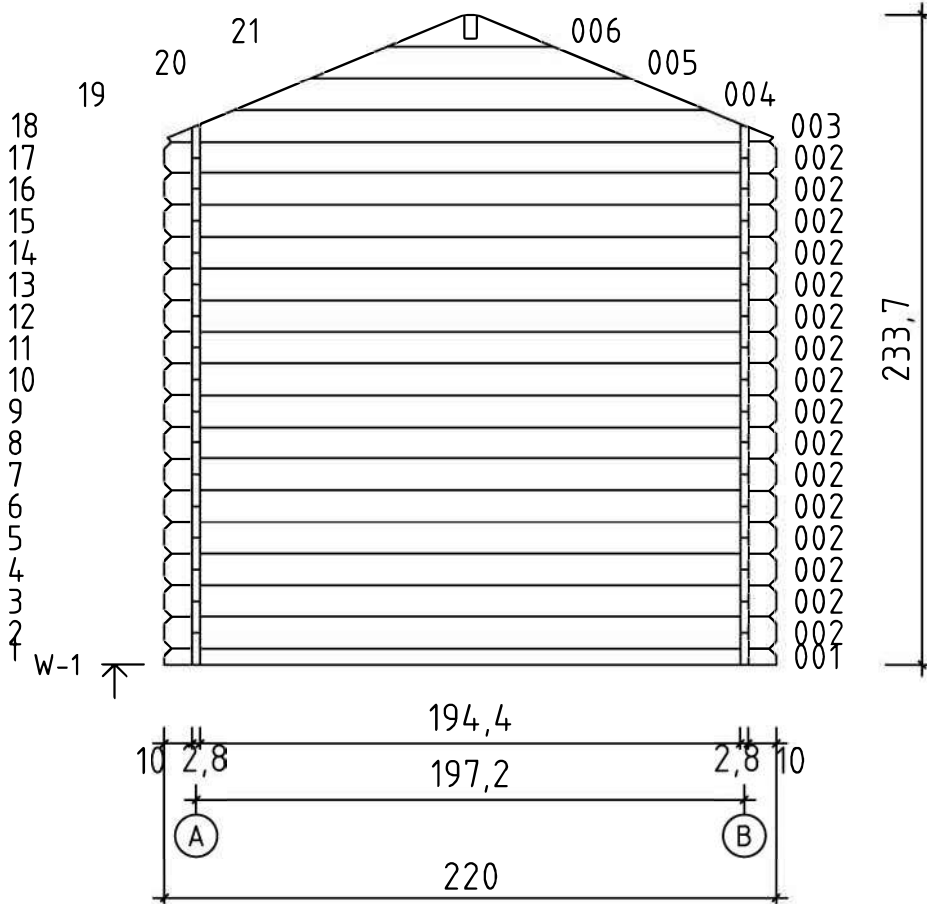

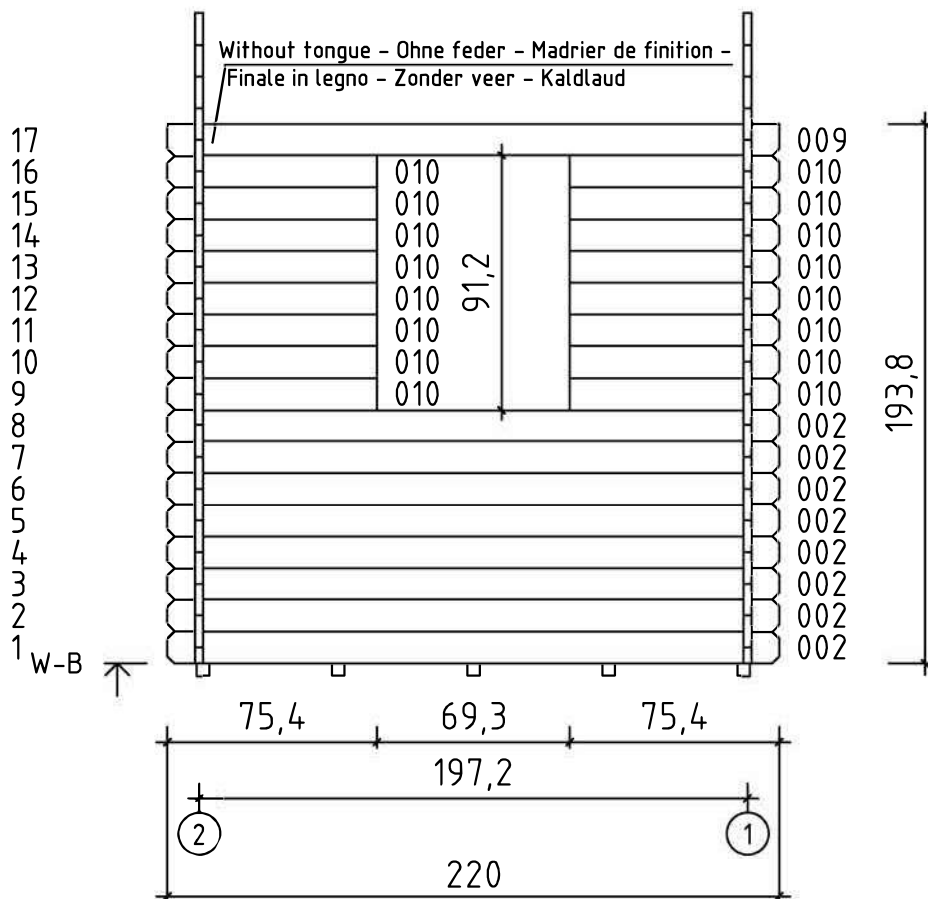
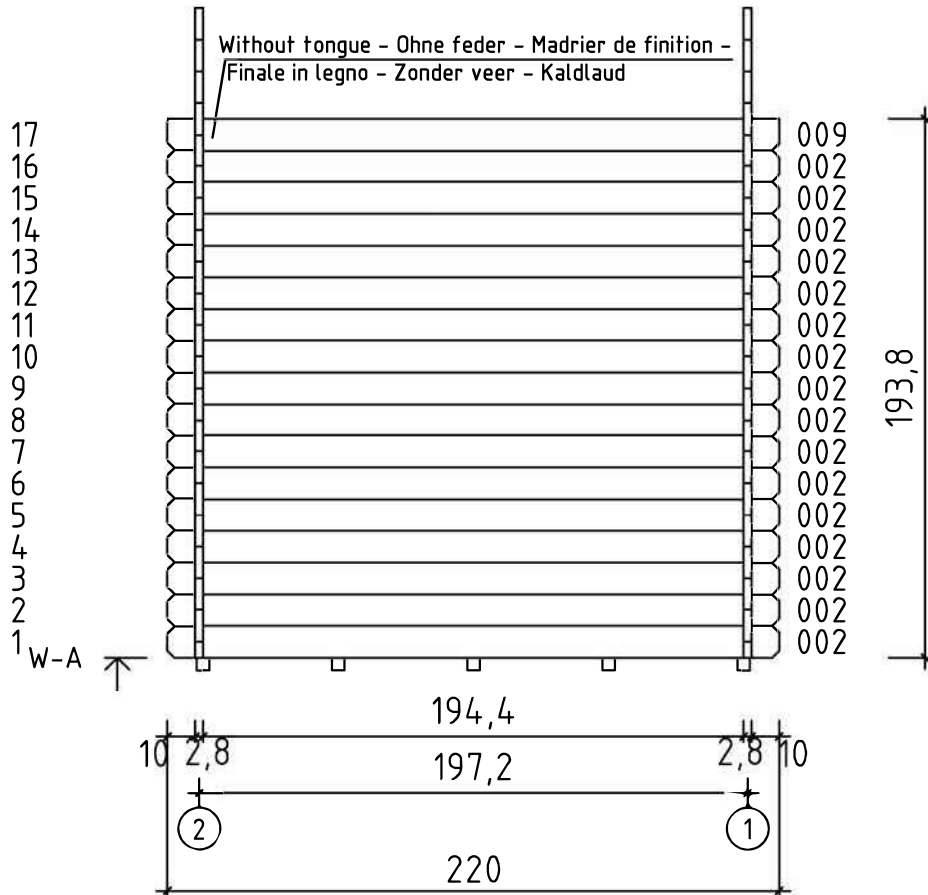

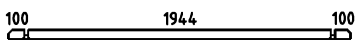
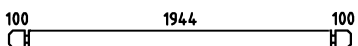
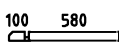
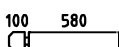
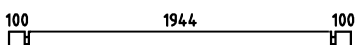
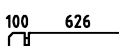
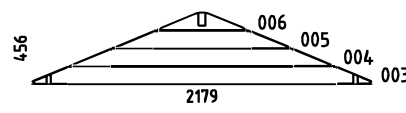
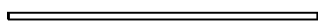
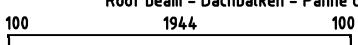
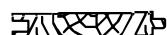
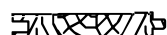



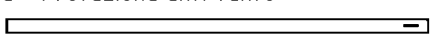
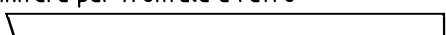
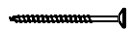
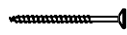

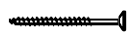
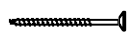

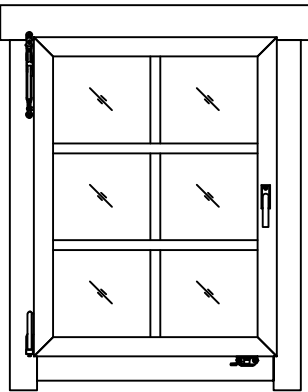
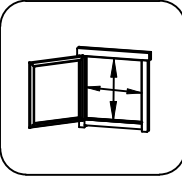

Floor boards - Fussbodenbretter - Plan pose plancher - Pavimento - Vloerhout - Põrandalaudis

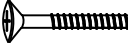
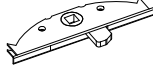

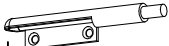

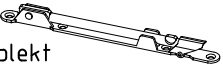
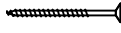
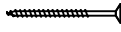

Pos	24.07.2018 Piece list - Stückliste - Liste des pièces - Elementi - Stuklijst - Tükitalabel Art.Nr. WC165262 6/7	Q	P (mm)	L (mm)
001		1	28x57	2200
002		40	28x114	2200
007		2	28x57	708
008		32	28x114	708
009		2	28x120	2200
010		16	28x114	754
W1-1 W2-1		1 1		
IAR1	Foundation - Fundament - Fondation - Fondamenta - Fundering - Immutatud alusraam 	5	45x45	1990
A-PR1	Roof beam - Dachbalken - Panne de toit - Perlina del tetto - Gordingen / dakbalk - Pärilin 	1	44x120	2200
	Floor boards - Fussbodenbretter - Lame de plancher - Pavimento - Vloerhout - Põrandalaud 	22	90x15	1940
	Roof boards - Dachbretter - Voliges - Perlina per tetto - Dakhout - Katuselaud 	50	90x15	1250
	Floor fillet - Fussbodenleiste - Corniere de finition du plancher - Finitura per pavimento (battisco pa) - Vloerafwerkljst - Põrandaliist 		18x18	7.76
	Roofing felt fillet - Dachpappenleiste - Baguette de fixation du feutre bitumeux - Asse per fissaggio guaina bituminosa - Afdeklijst asfaltpapier - Katussepapiliist 	4	15x45	1300
DRV-1	Roof edge reinforcement - Dachrandverstärkung - Corniere de renfort de bord de toit - Rinforzo x tetto - Dakrand versterking - Räästatugevdus 	2	15x45	2200
KFS-1	Storm protection - Sturmleiste - Latte anti-tempete - Protezione anti vento - Stormverankering / beveiliging - Tormikinnitusliist 	4	22x45	2050
	Gable moulding - Giebelleiste - Planche de rive - Finitura per frontale e retro del tetto - Gevellijst - Viilulaud 	4	15x120	1300
HS8	Screw for gable segment - Schrauben für deckblatt - Vis pour fixation losange de finition - Viti x frontali tetto - Schroef voor gevelpunt segment - Kruvi rombile 	4	3.5x35	
HS9	Screw for gable moulding - Schrauben für giebelleiste - Vis pour fixation planche de rive - Vite per fissare finiture davanti e dietro del tetto - Schroef voor gevellijst - Kruvi viilulauale 	16	3.5x50	
HS4	Screw for roof edge reinforcement - Schrauben für dachrandverstärkung - Vis pour fixation corniere renfort de bord de toit - Viti x rinforzo bordo tetto - Schroef voor dakrand versterking - Kruvi räästatugevdusele 	10	3x30	
HS18	Screw for roof beams - Schrauben für dachbalken - Vis pour fixation pannes de toit - Viti per perline del tetto - Schroef voor gordingen / dakbalken - Kruvi pärlinitele 	2	5x120	
HS18	Screw for gable - Schrauben für giebel - Vis pour fixation des pignons - Viti per timpano - Schroef voor gevelpunt - Kruvi viilude kinnitamiseks 	4	5x120	
HS16	Screw for 1. wall beam - Schraube für 1. bohlenreihe - Vis de fixations 1ere rangée de madriers avec poutrelles de fondations - Vite fissaggio alle fondamenta - Schroef voor 1 wandbalk - Kruvi poollauale 	4	5x90	

Pos	19.12.2017	Piece list - Stückliste - Liste des pièces - Elementi - Stuklijst - Tükitalabel 685x882 AK.1.106.SSV.d SGA	1/1	Q	P (mm)	L (mm)
		Glass size - Glasgröße - Taille de la vitre - Misura del vetro - Glas afmeting - Klaasi mõõt: 542x738 mm				
					585x782 mm	
1		Georgian bars - Sprossen - Croisillons - La griglia georgiana - Raamverdeling - Petteliistud		1	15x25	757
2		Georgian bars - Sprossen - Croisillons - La griglia georgiana - Raamverdeling - Petteliistud		2	15x25	576
FS1		Window handle fittings - Fenstergriff - Poignée de fenetre - Maniglia c/ferramenta - Raamhendel -/grendel -/klink - Aknalink		1		
FSP		Bolt for window handle fittings - Bolzen für fenstergriff beschlag - Vis pour fixation poignée de fenetre - Bullone x apertura manuale finestra - Schroef voor raamhendel - Akna käepideme pölt		2		
FSL		Window closer - Fenstergriff - Système de fermeture pour fenêtre - Serratura della finestra - Raamslotje - Akna sulguri südamik		1		
FSA		Window closer striker - Gegenstück für Fenstergriff - Entrebâilleur de fenetre - Attacco aggancio per serratura della finestra - Raam sluitplaatje - Akna luku vastus		1		
NA1		Tilt & turn window set - Dreh-Kipp-Beschlag für Fenster - Ensemble de fenêtres oscillo-battantes - Insieme per il fermo dell'oscillazione del battente della finestra - Draaikiep raamsetje - Kald-pöördsuluse komplekt		1		
NA2		Tilt & turn window set - Dreh-Kipp-Beschlag für Fenster - Ensemble de fenêtres oscillo-battantes - Insieme per il fermo dell'oscillazione del battente della finestra - Draaikiep raamsetje - Kald-pöördsuluse komplekt		1		
NA3		Tilt & turn window set - Dreh-Kipp-Beschlag für Fenster - Ensemble de fenêtres oscillo-battantes - Insieme per il fermo dell'oscillazione del battente della finestra - Draaikiep raamsetje - Kald-pöördsuluse komplekt		1		
NA4		Tilt & turn window set - Dreh-Kipp-Beschlag für Fenster - Ensemble de fenêtres oscillo-battantes - Insieme per il fermo dell'oscillazione del battente della finestra - Draaikiep raamsetje - Kald-pöördsuluse komplekt		1		
NA5		Tilt & turn window set - Dreh-Kipp-Beschlag für Fenster - Ensemble de fenêtres oscillo-battantes - Insieme per il fermo dell'oscillazione del battente della finestra - Draaikiep raamsetje - Kald-pöördsuluse komplekt		1		
NA6		Tilt & turn window set - Dreh-Kipp-Beschlag für Fenster - Ensemble de fenêtres oscillo-battantes - Insieme per il fermo dell'oscillazione del battente della finestra - Draaikiep raamsetje - Kald-pöördsuluse komplekt		1		
HS1		Screw for georgian bars - Schraube für sprossen - Vis pour croisillons - Viti per unire la griglia georgiana della finestra - Schroeven voor raamverdeling - Kruvi akna petteliistule		6	2.5x20	
HS31		Screw for window closer striker - Schraube für Gegenstück / Fenstergriff - Vis pour entrebâilleur de fenetre - viti per attacco della serratura della finestra - Schroef voor raam sluitplaatje - Kruvi akna luku vastusele		2	3.5x15	
HS10		Screw for tilt & turn window set - Schraube für Dreh-Kipp-Beschlag - Vis pour système oscillo-battant - Viti per attacco dell'insieme del fermo per oscillazione del battente della finestra - Schroeven voor draaikiepssetje - Kruvi kald-pöördsuluse komplektille		14	4x25	

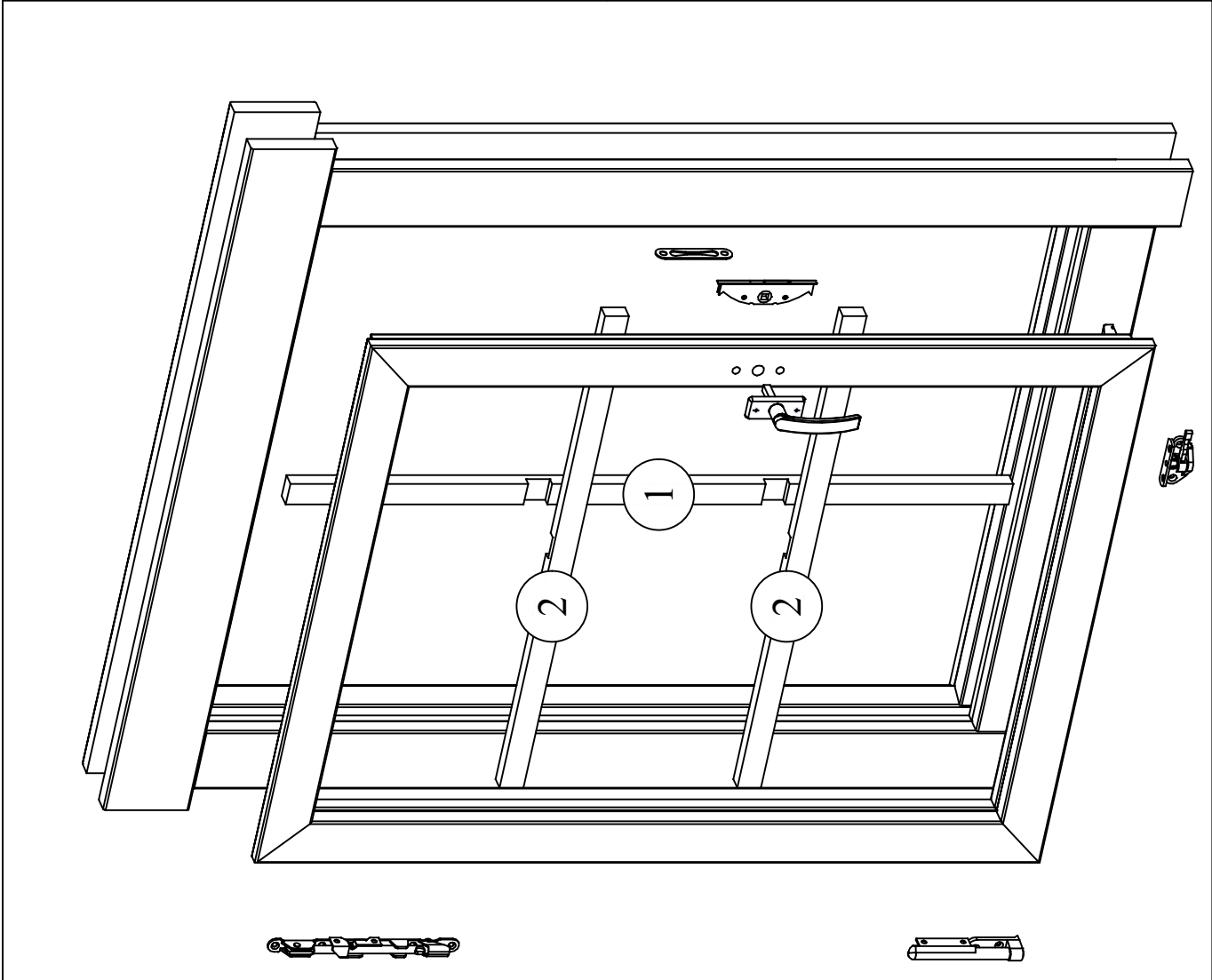
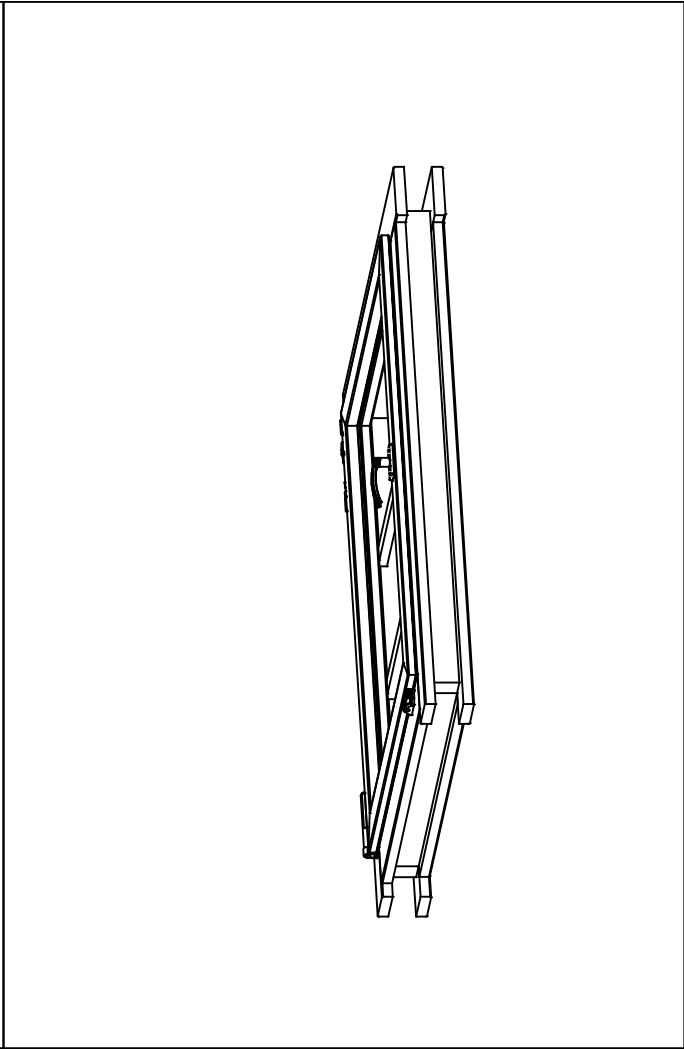
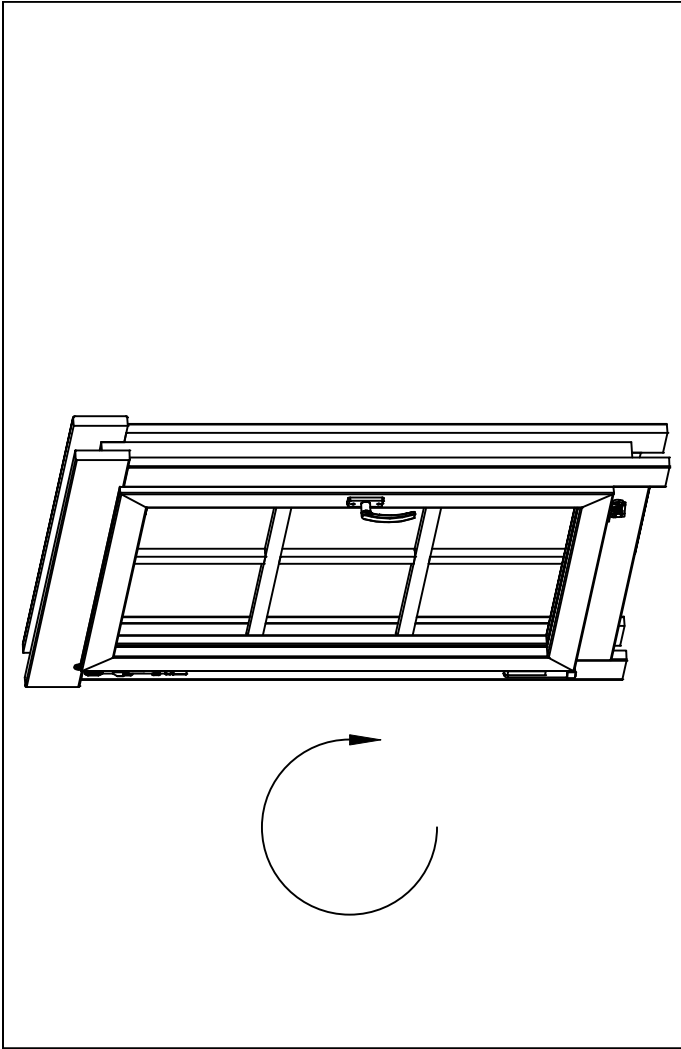

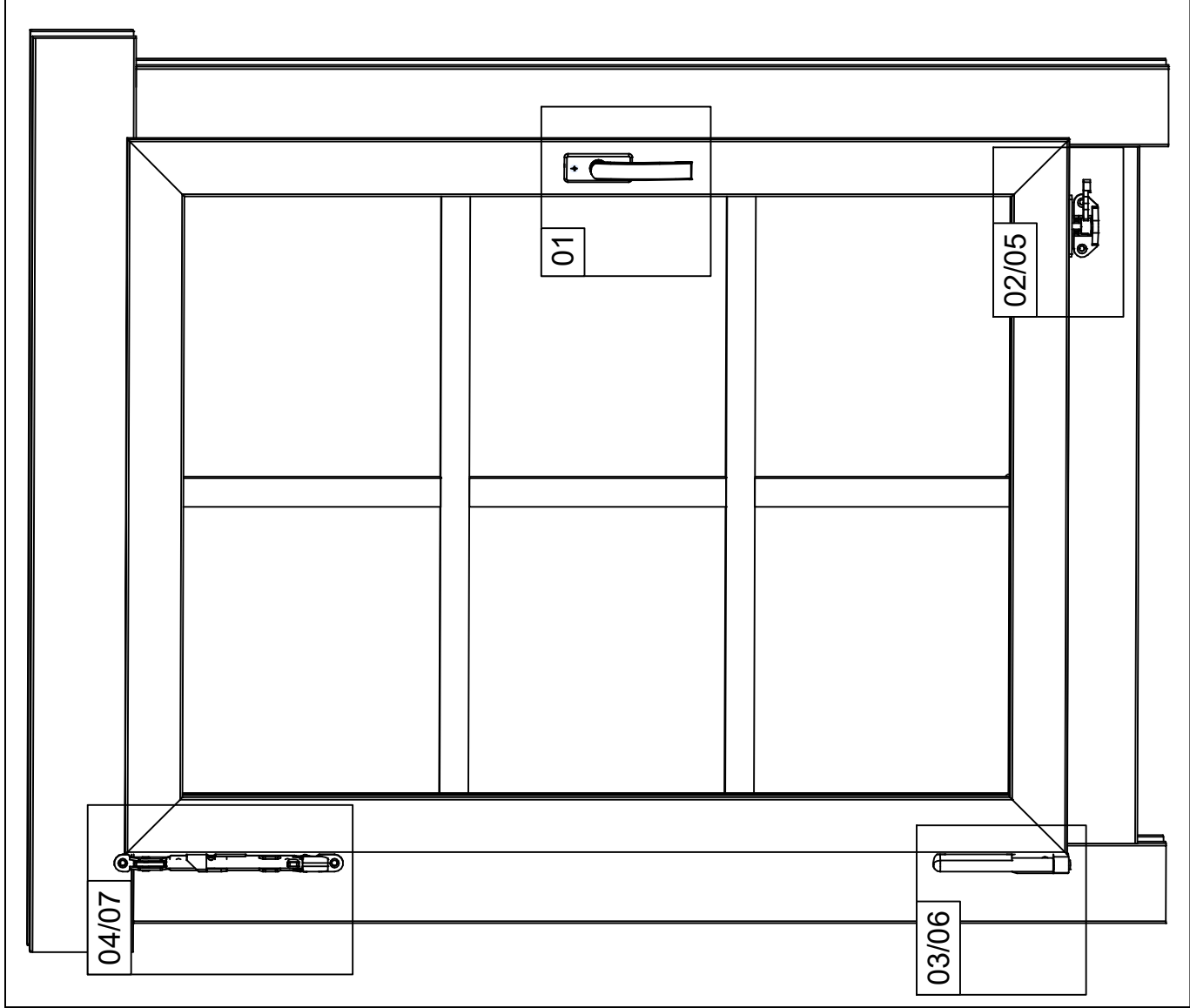
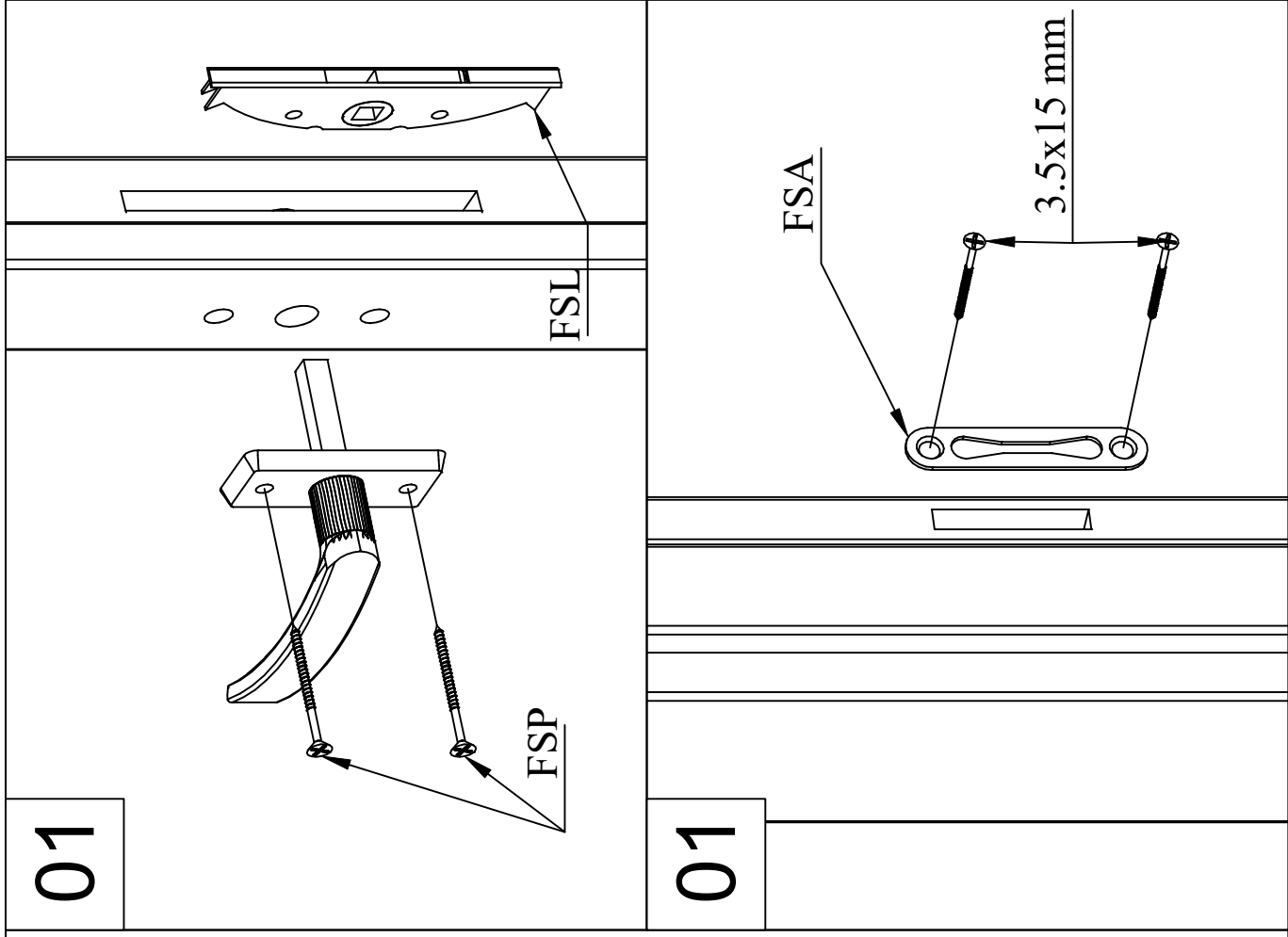

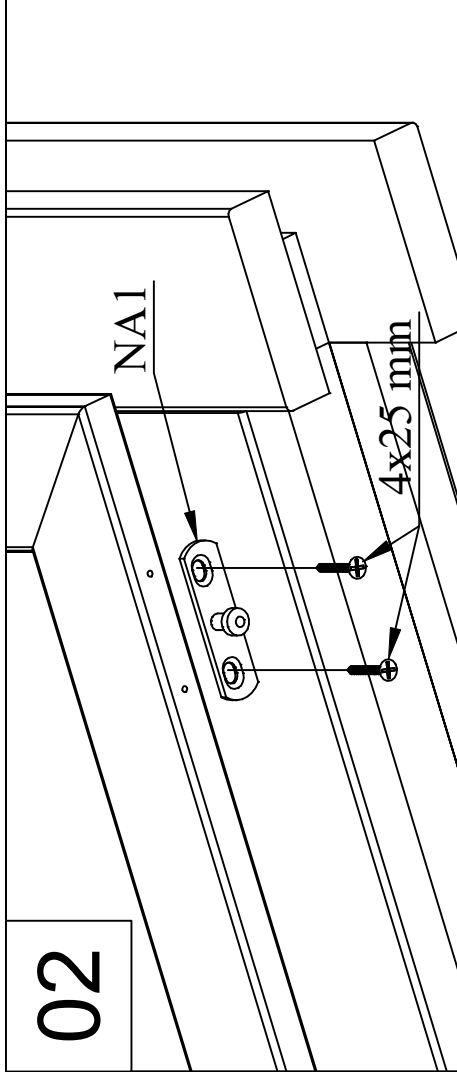

02

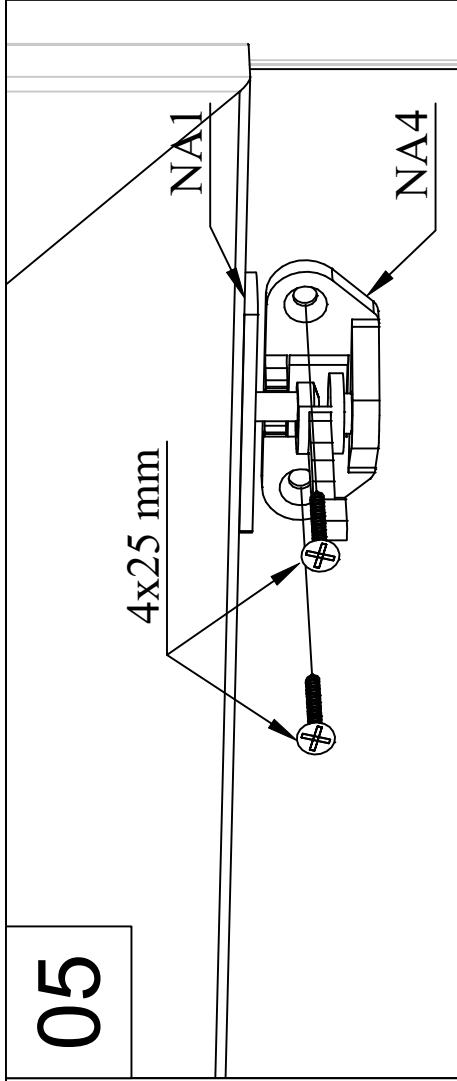

05

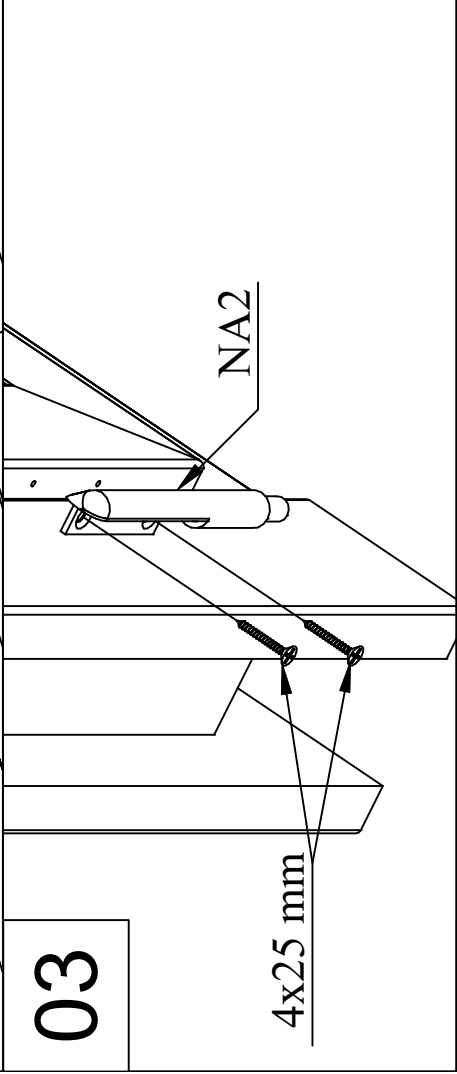

03

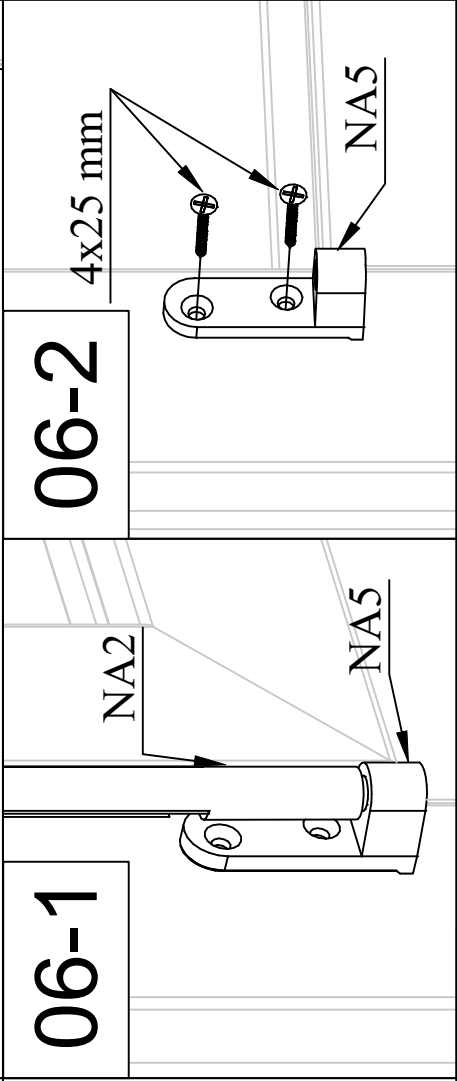

06-1

06-2

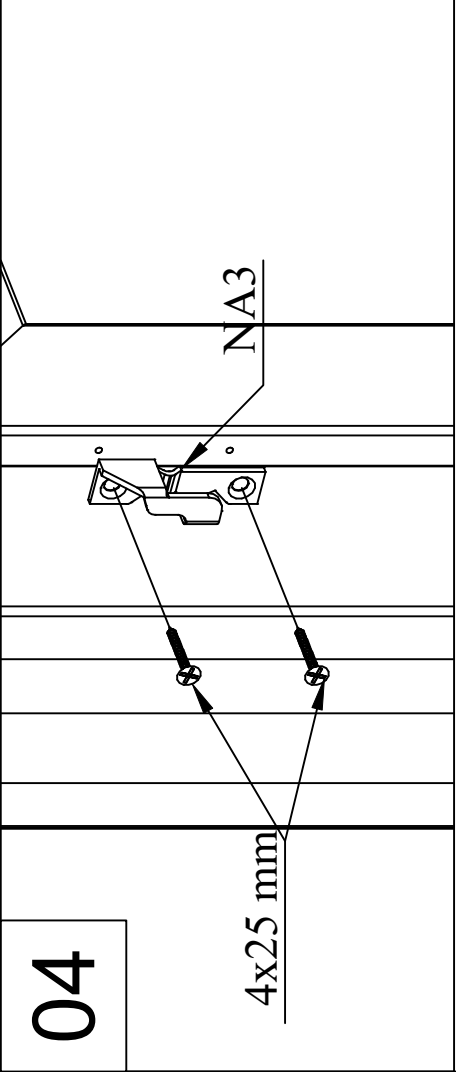



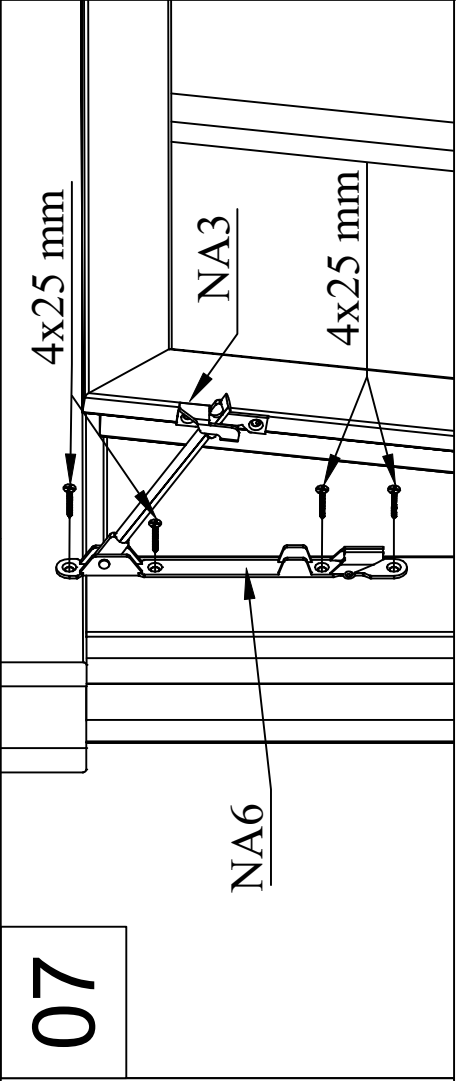

04

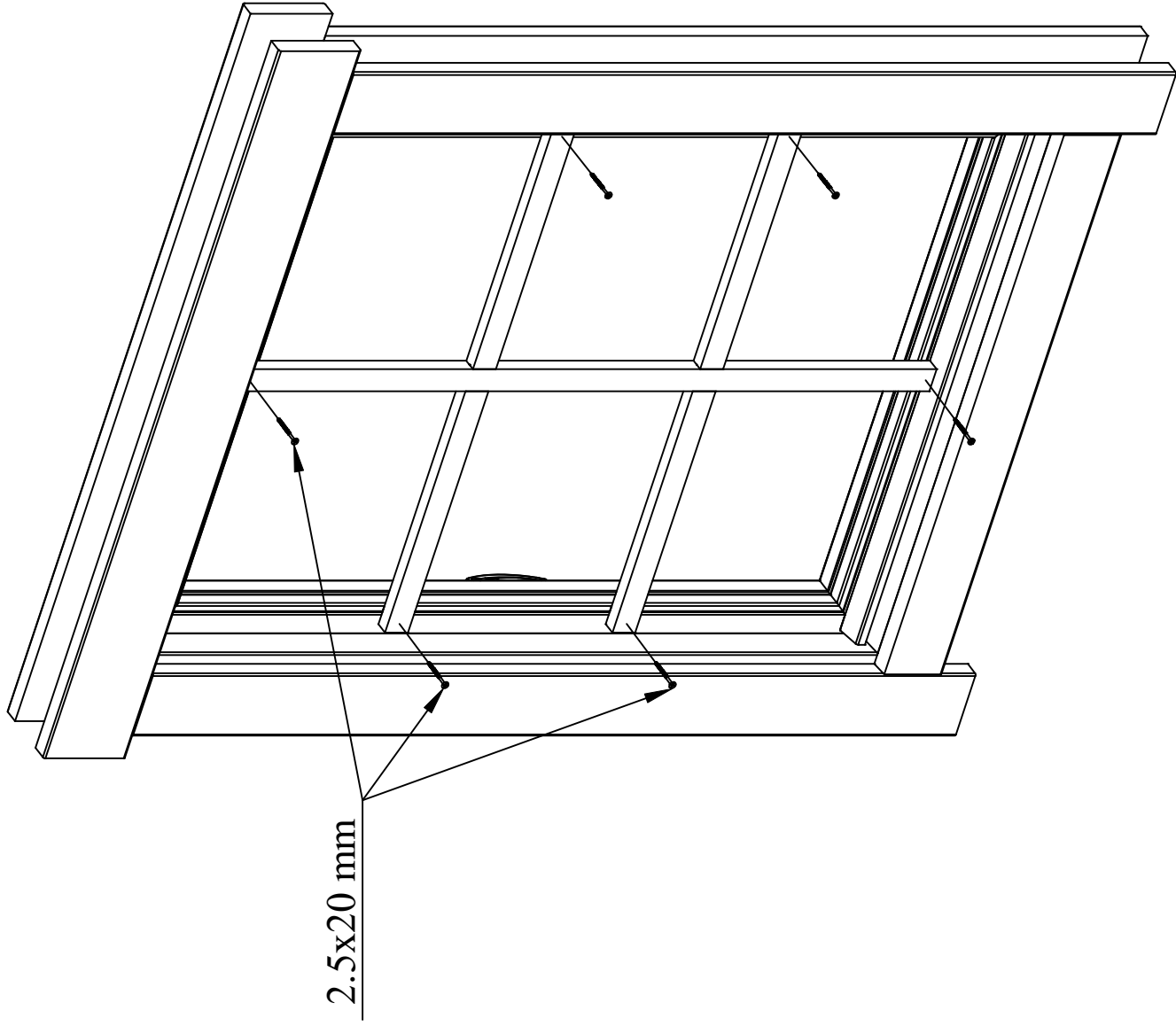

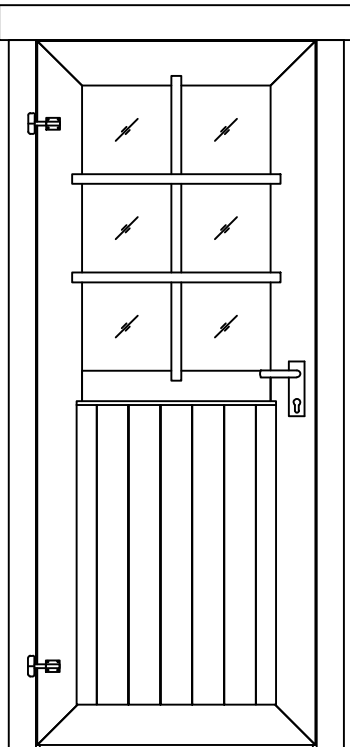
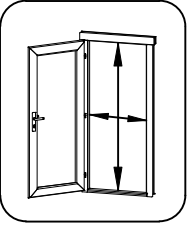
07



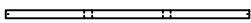
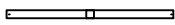

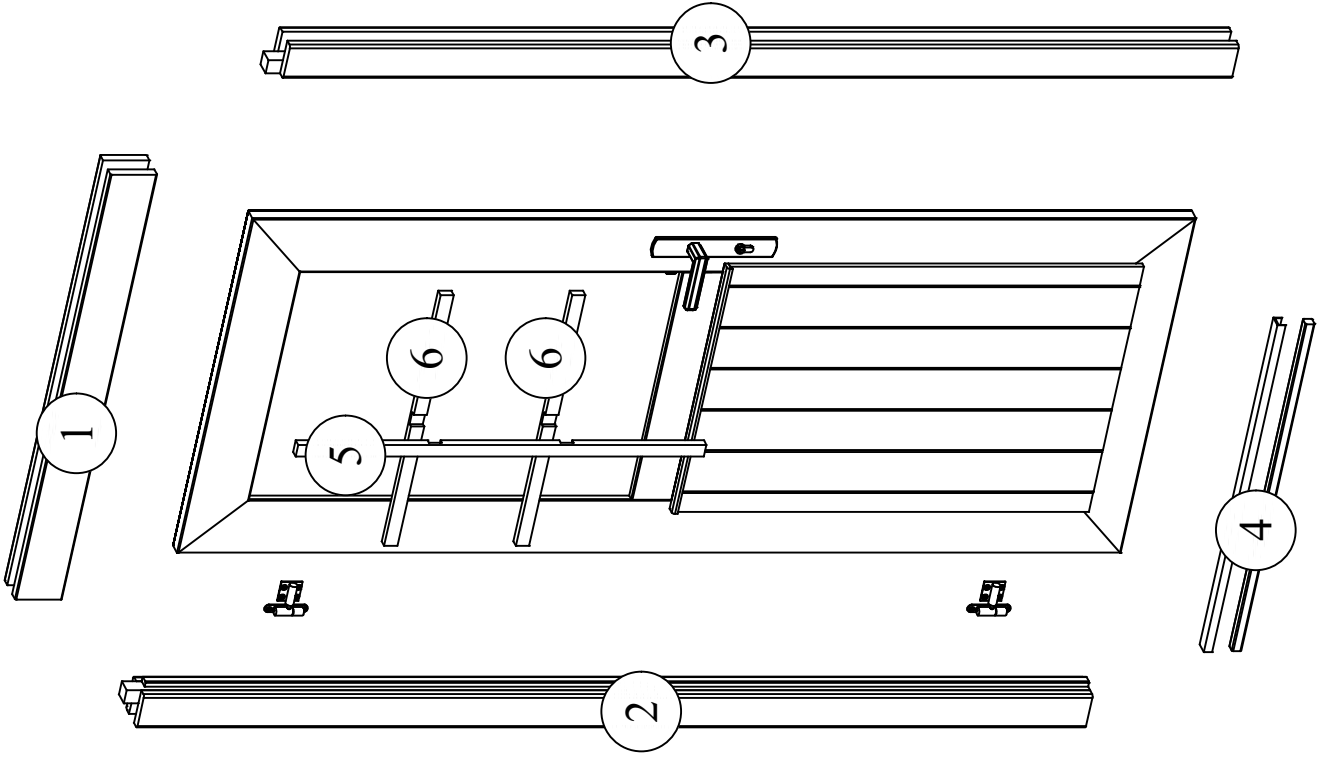

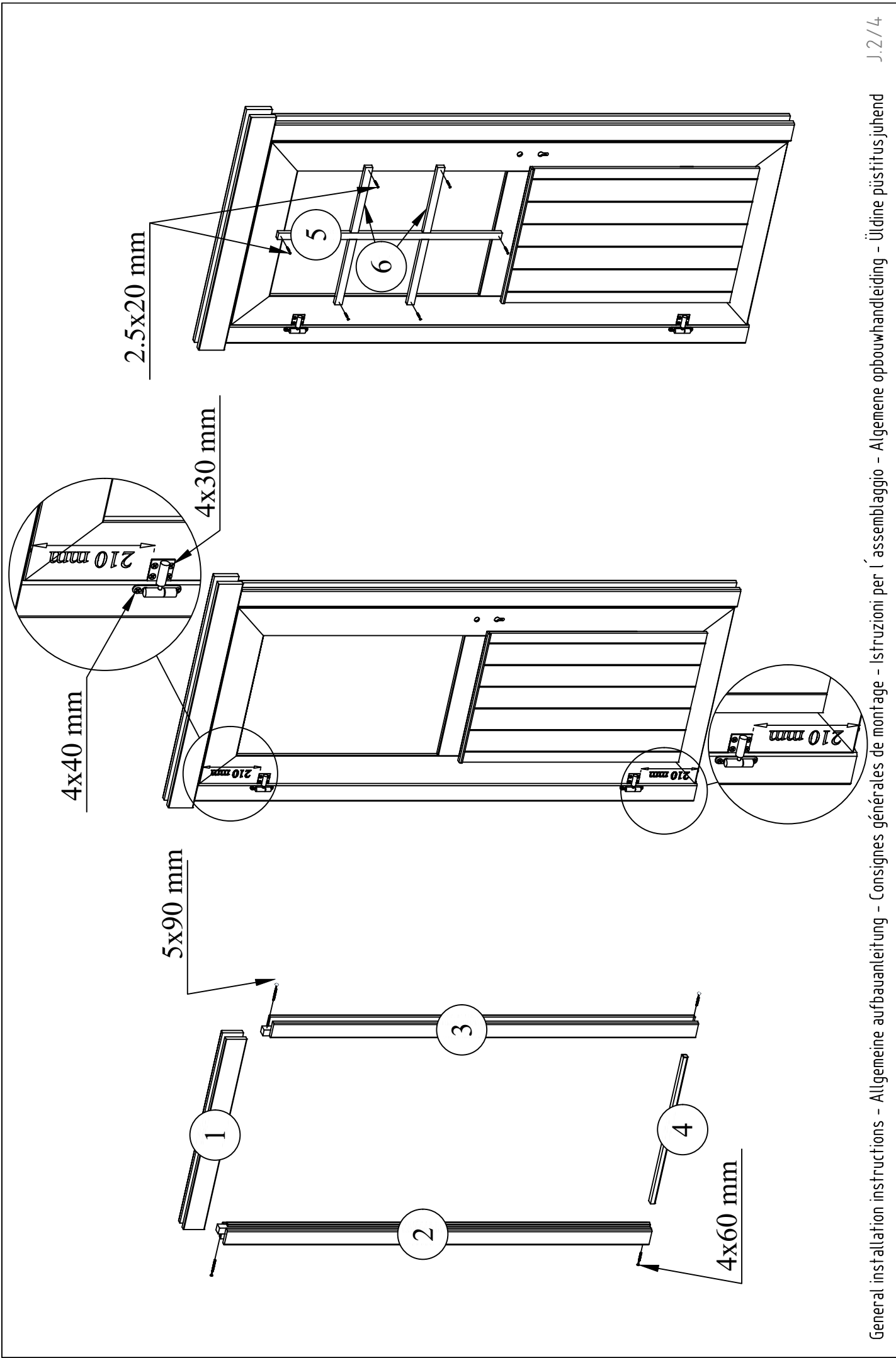

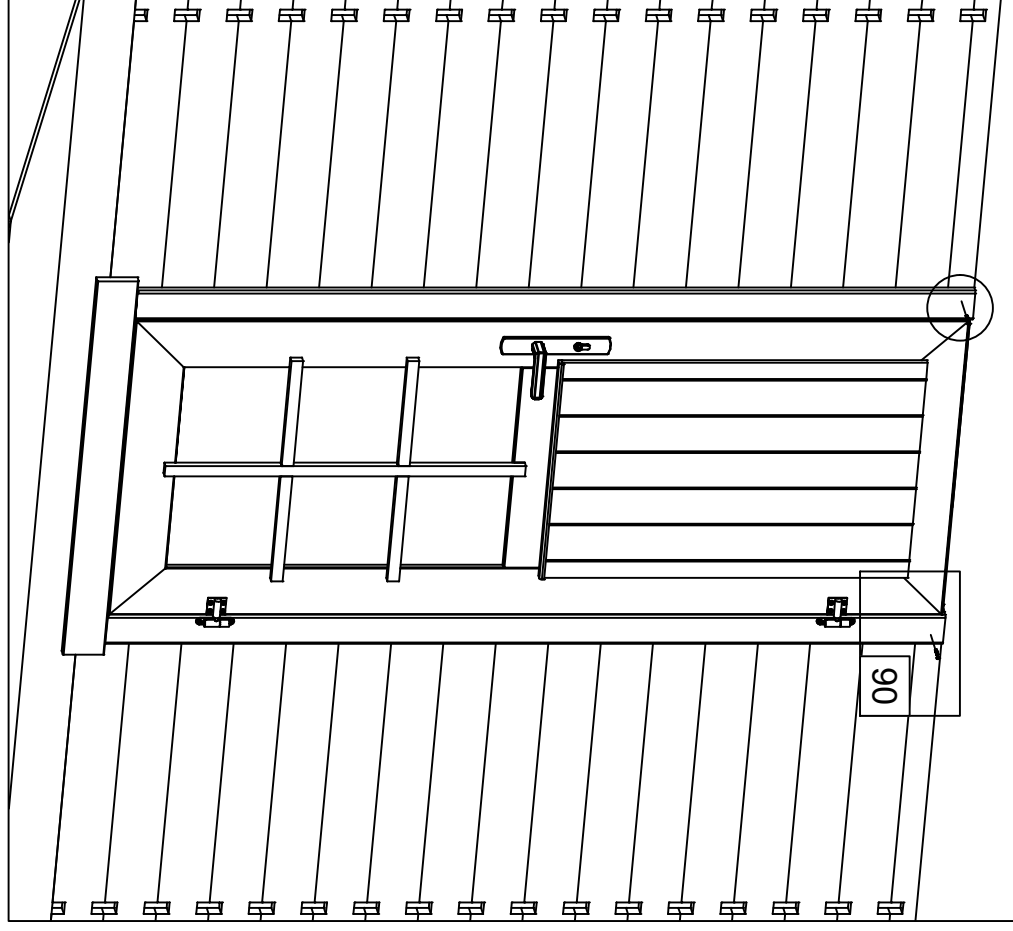
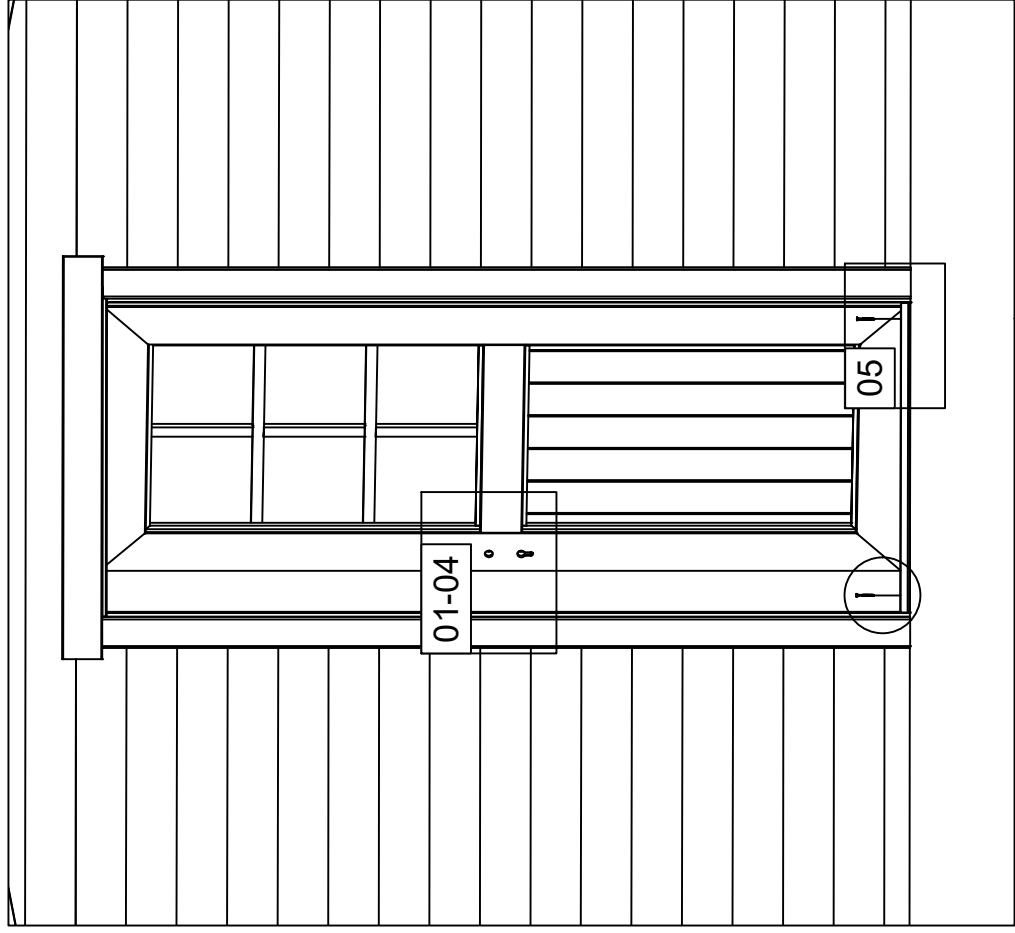
Pos	21.12.2017	Piece list - Stückliste - Liste des pièces - Elementi - Stuklijst - Tükítabel 775x1850 UK.2.056.SVV.MMX28 SGA+28	1/2	Q	P (mm)	L (mm)
		Glass size - Glasgröße - Taille de la vitre - Misura del vetro - Glas afmeting - Klaasi mõõt: 502x750 mm				
		  <p>702x1793 mm</p>				
1	Upper door jamb - Türrahmen oben - Cadre de porte supérieur - Telaio superiore della porta - Bovendorpel - Ukse ülemine leng		1	66x100	912	
2	Left door jamb - Türrahmen links - Cadre de porte gauche - Telaio montante sinistro della porta - Linkerstijl deurframe - Ukse vasak leng		1	66x80	1850	
3	Right door jamb - Türrahmen rechts - Cadre de porte droit - Telaio montante destro della porta - Rechterstijl deurframe - Ukse parem leng		1	66x80	1850	
4	Doorstep - Swelle - Barre de seuil - Soglia della porta - Deurdorpel - Lävepak		1	20x21	702	
5	Georgian bars - Sprossen - Croisillons - La griglia georgiana - Raamverdeling - Petteliistud		1	15x25	784	
6	Georgian bars - Sprossen - Croisillons - La griglia georgiana - Raamverdeling - Petteliistud		2	15x25	536	

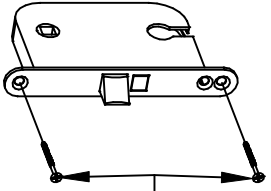

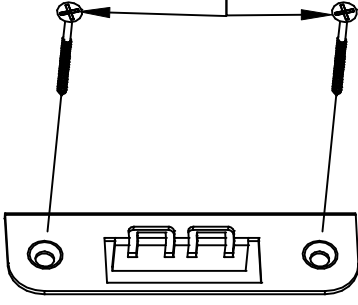
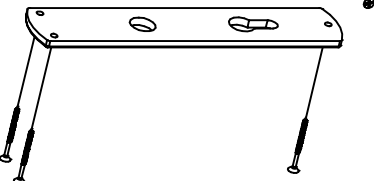

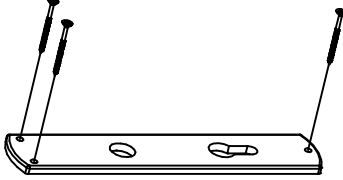
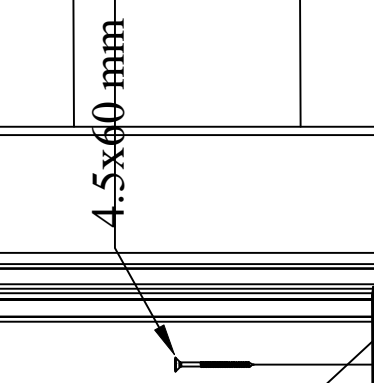

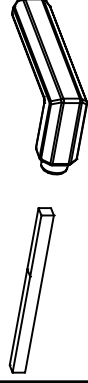
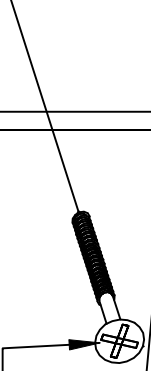
01	 <p>4x25 mm</p>			04	 <p>4x25 mm</p>
02				05	 <p>4.5x60 mm</p>
03				06	 <p>3.5x50 mm</p>