

MODULARO™

WOODEN CABIN VIENNA

5.7 x 3.8 x 2.45 m



Art.Nr. WC165002

Groundplan - Grundplan - Plan de masse - Planimetria - Plattegrond - Põhiplaan

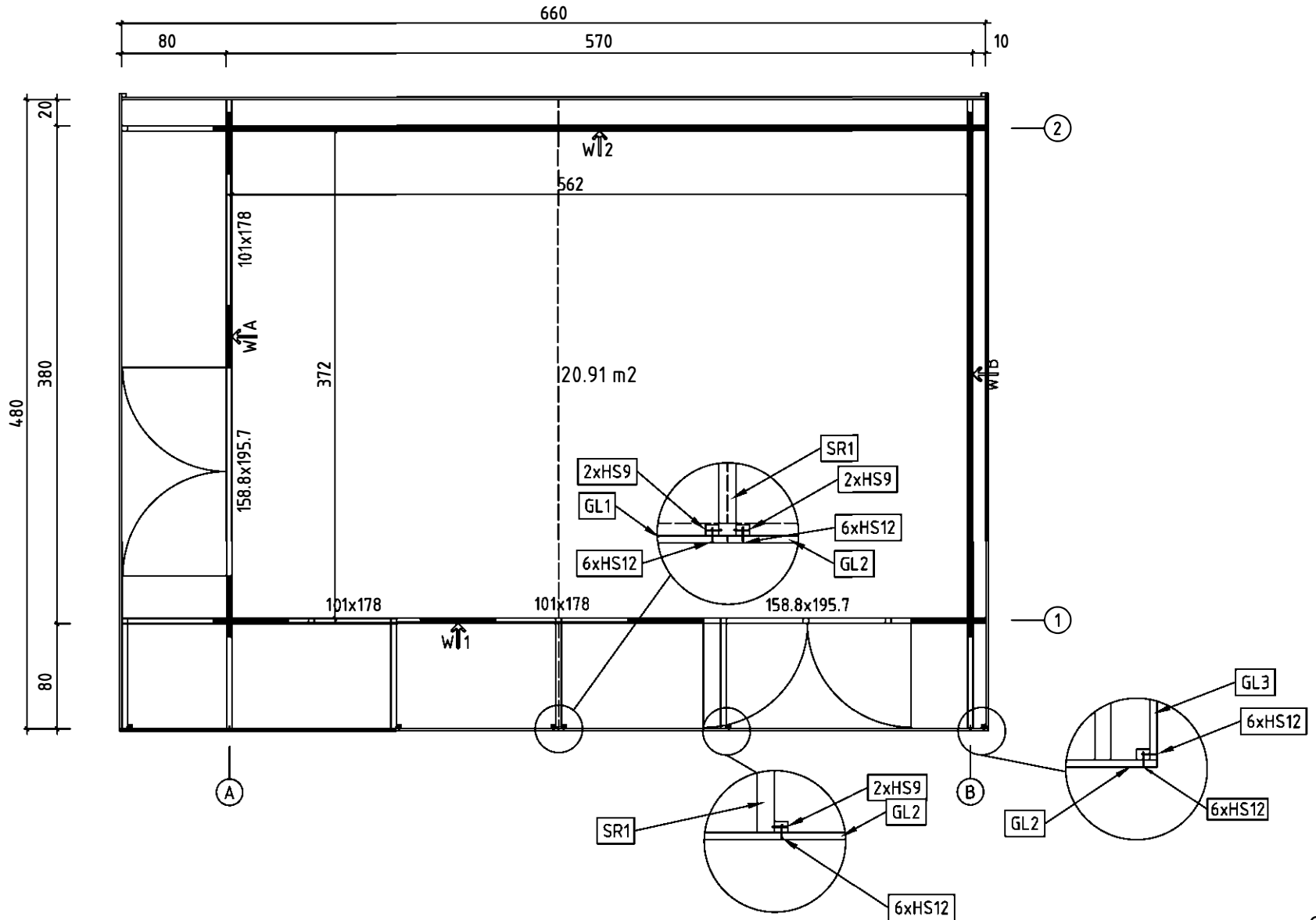

Art.Nr. WC165002

Foundation - Fundament - Fondation -
Fondamenta - Fundering - Immutatud alusraam

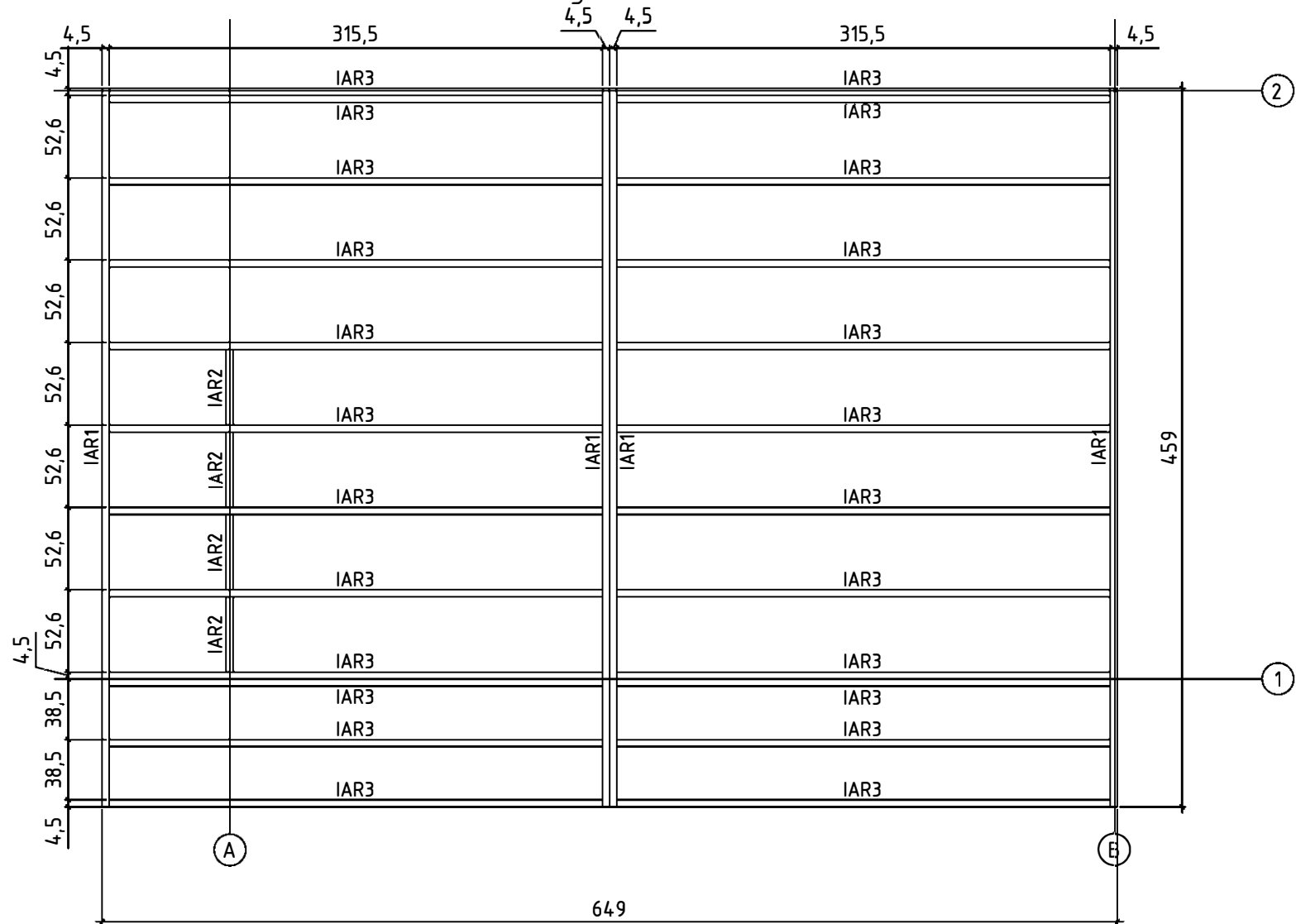

Art.Nr. WC165002

Floor boards - Fussbodenbretter - Plan pose plancher -
Pavimento - Vloerhout - Põrandalaudis

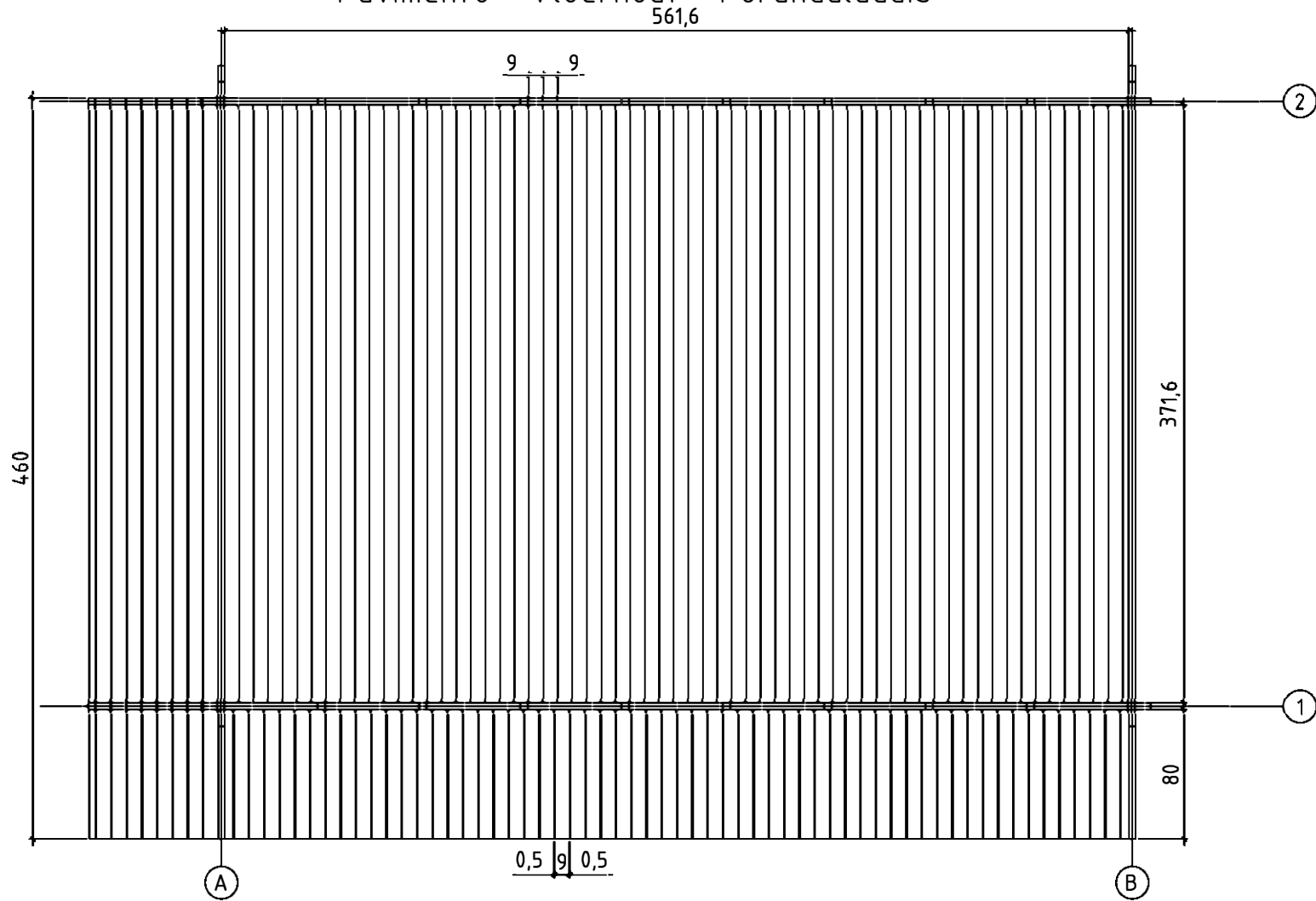

Terrace boards - Terrassenbretter - Plancher de terrasse -
Piattaforme terrazzo - Terrasvloer - Terrassilaudis

12.07.2019

4/13

Rafters plan - Dachsparren - Plan de chevron - Piano di travi - Dak spar constructie plattegrond - Sarikaplaan

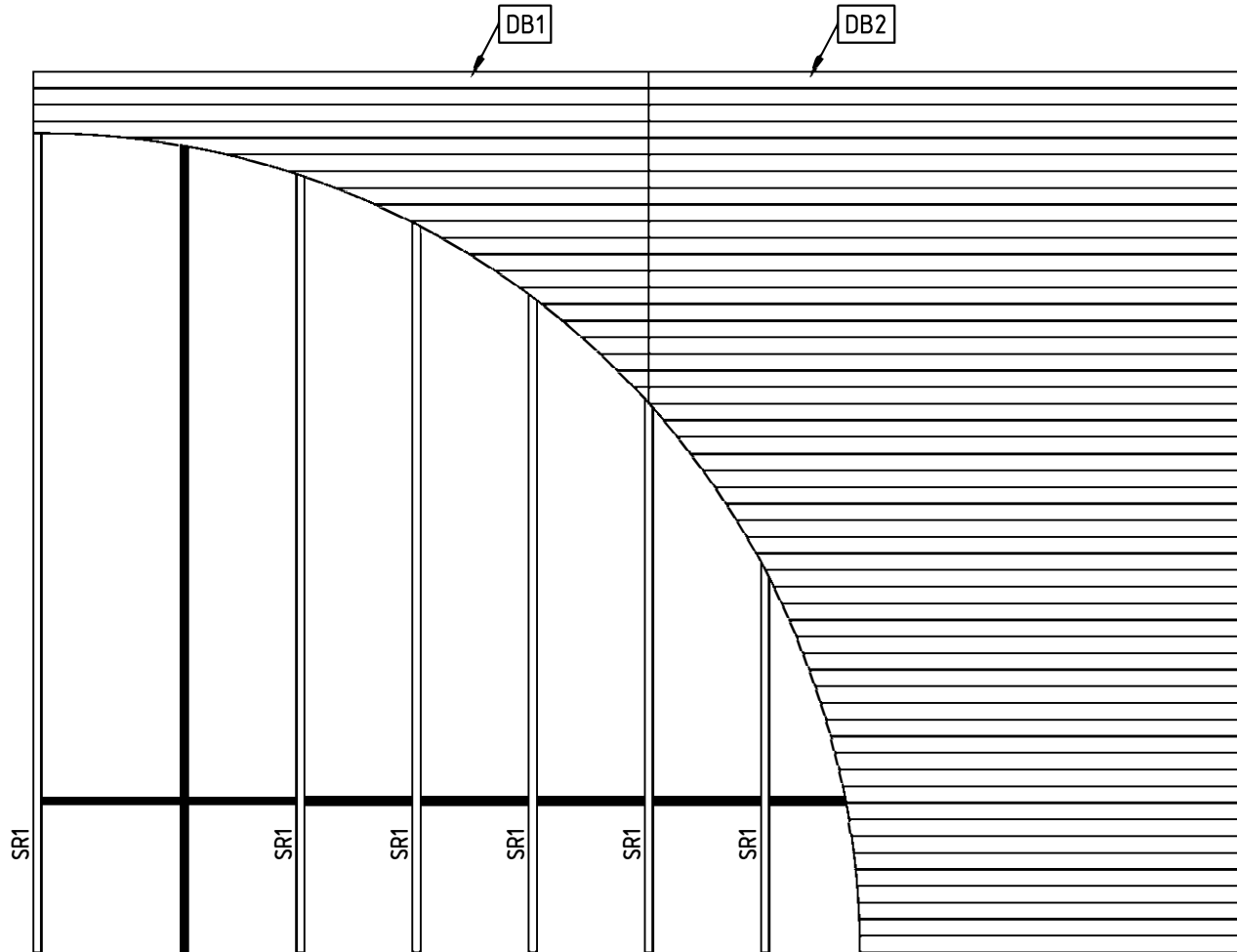

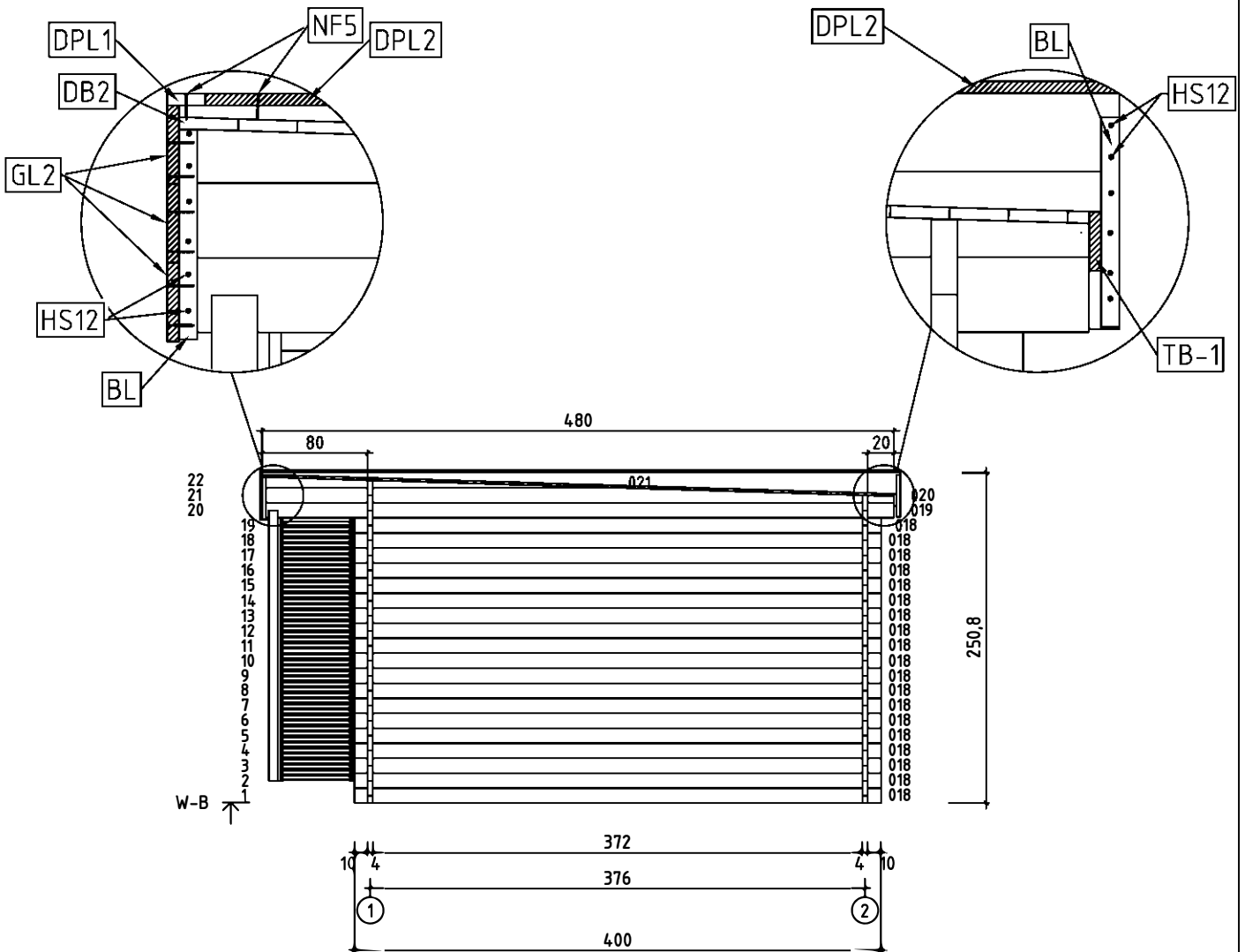
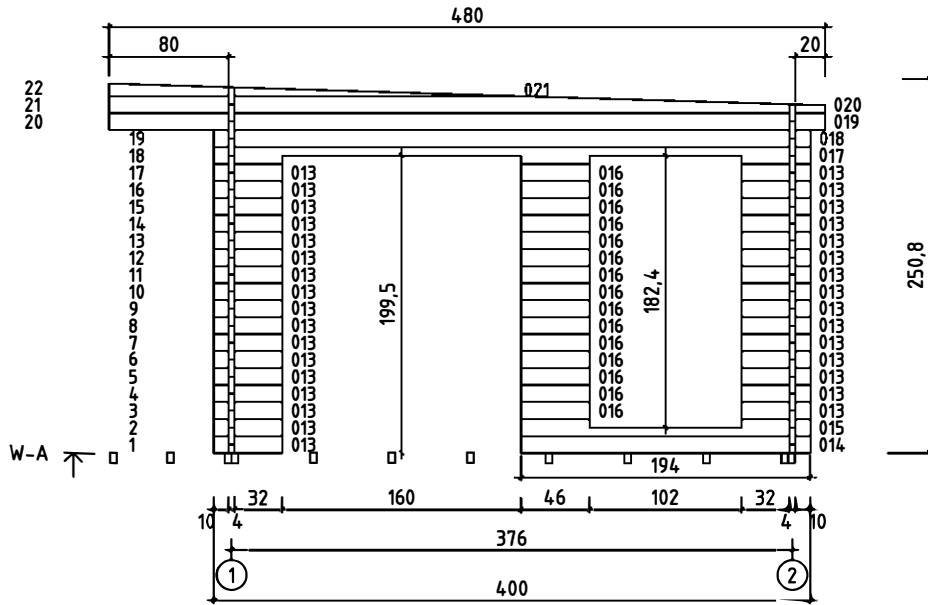

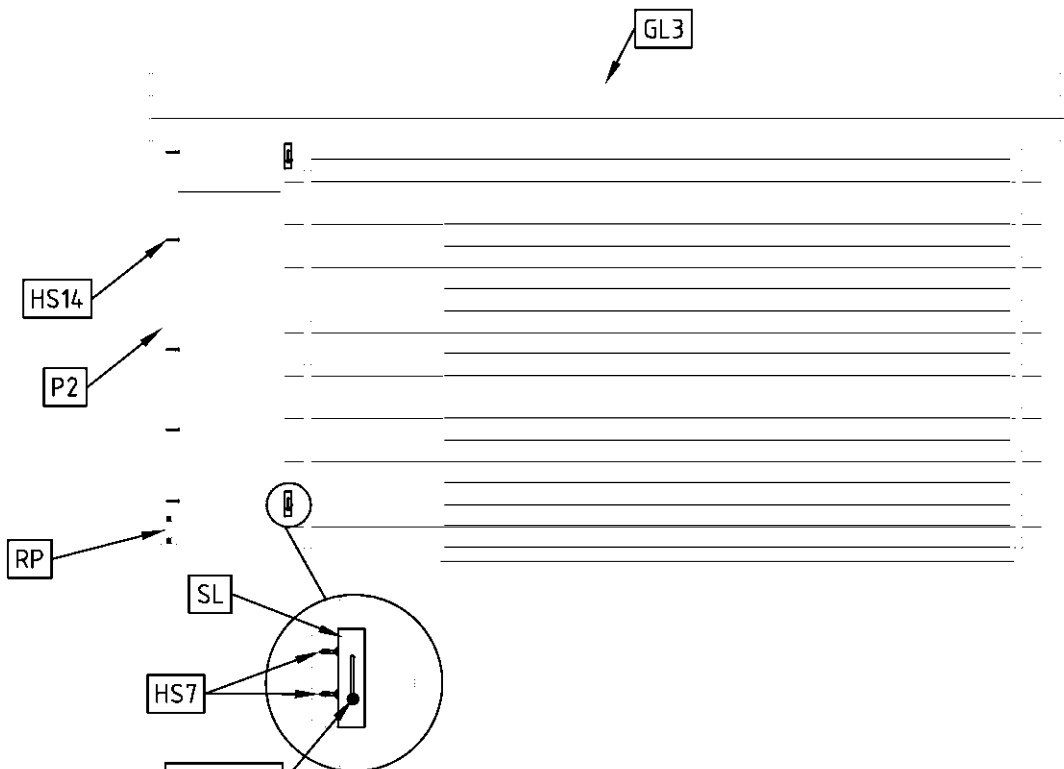



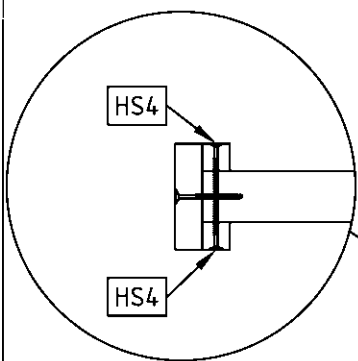
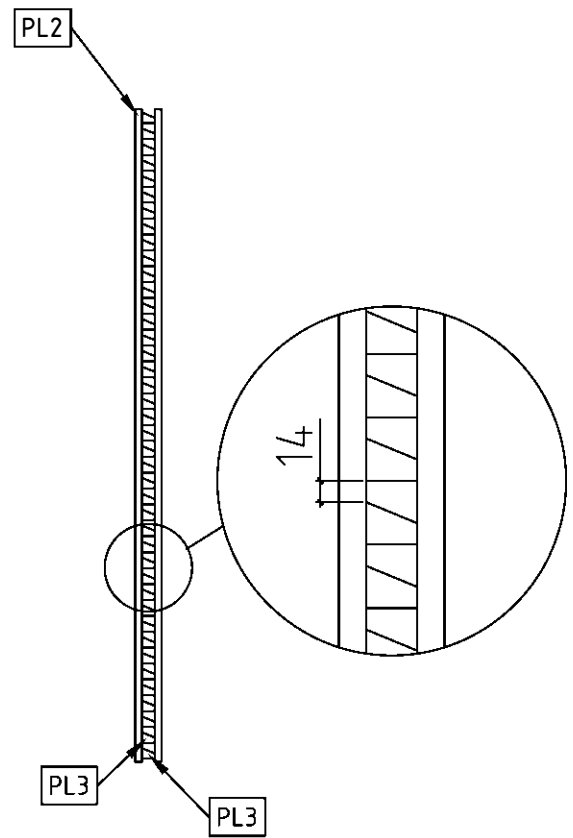
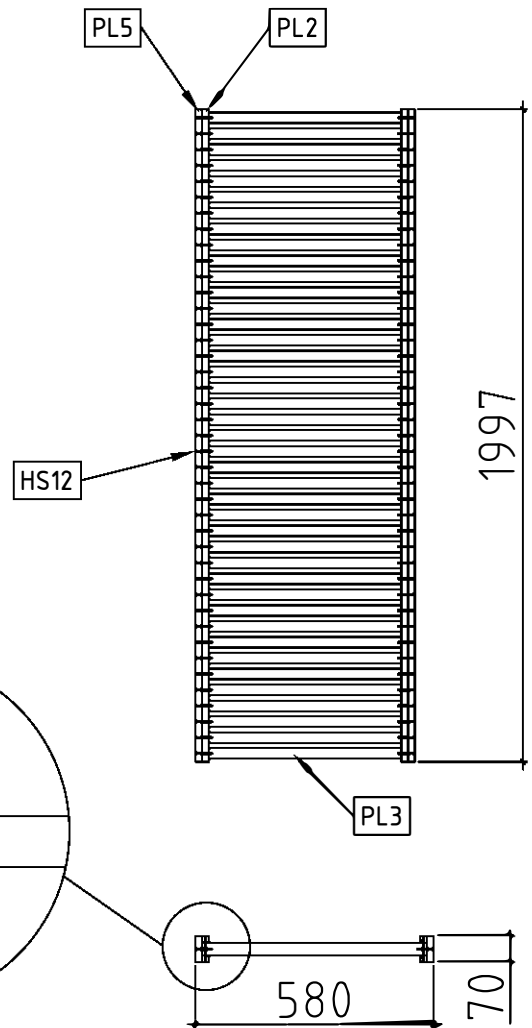

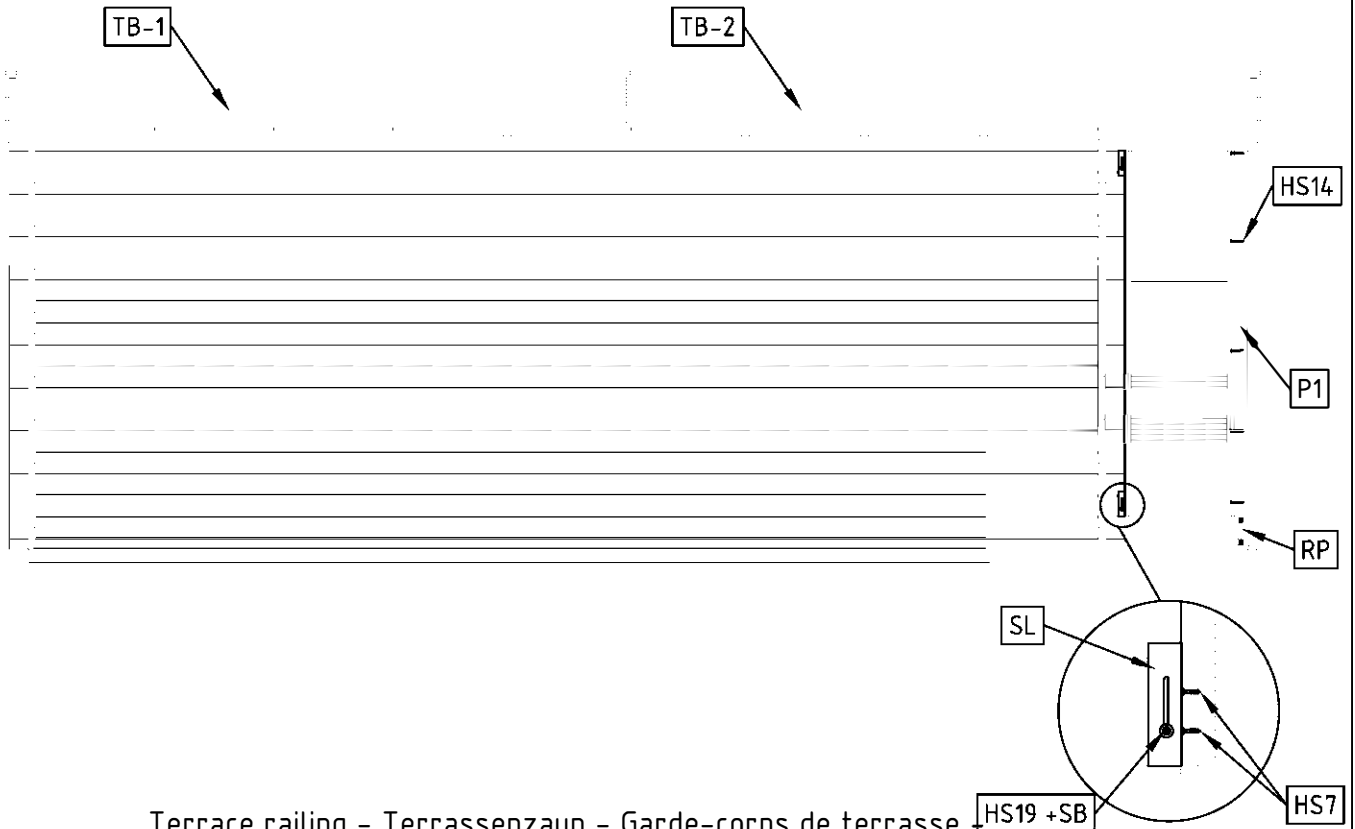



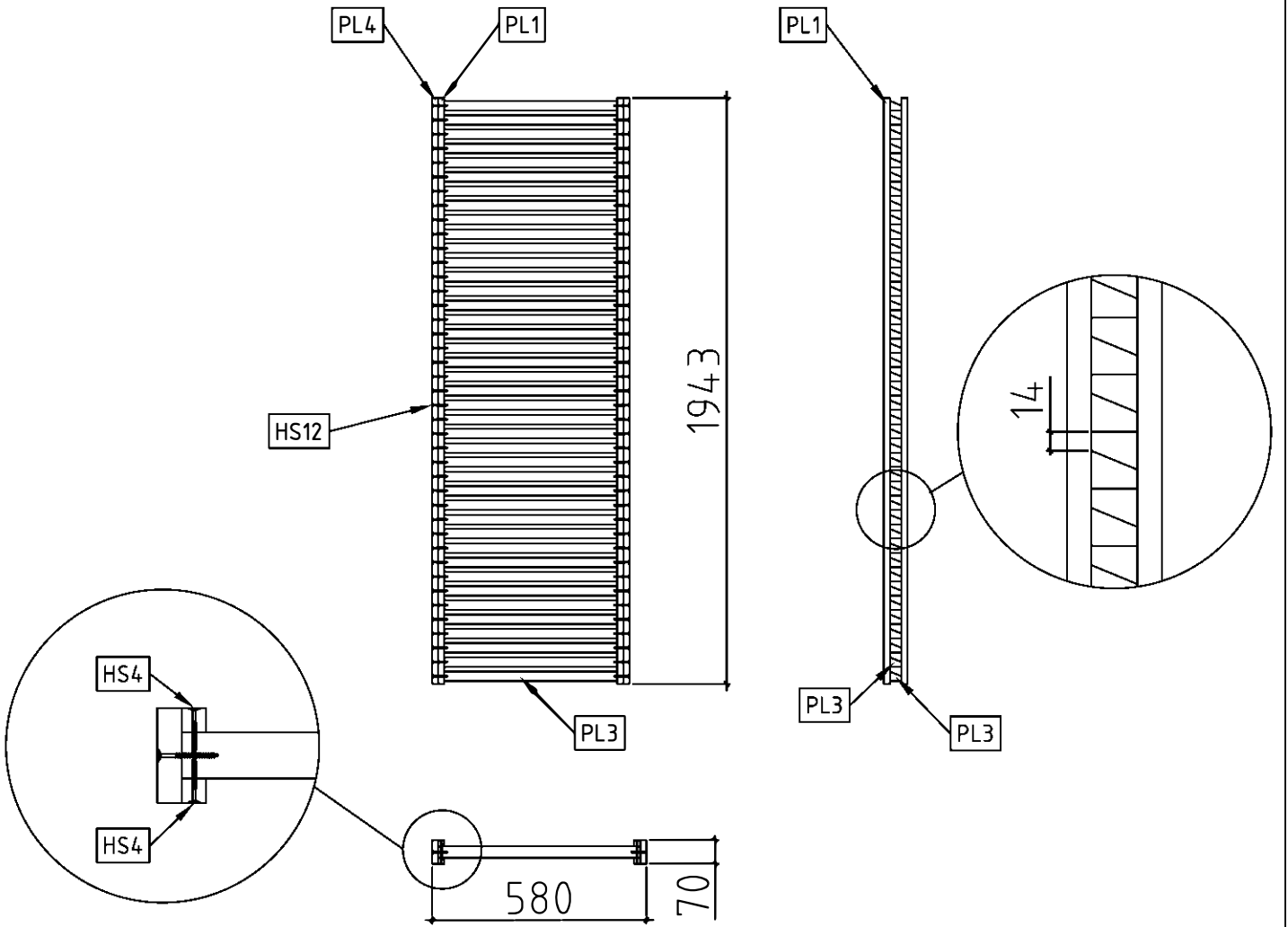

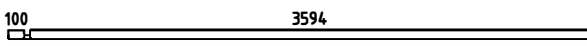

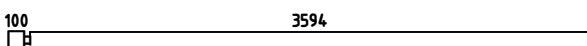
Terrace railing - Terrassenzaun - Garde-corp de terrasse -
Ringhiera per terrazza - Terras rails (leuning) - Piirdeaed

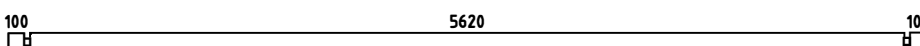
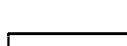
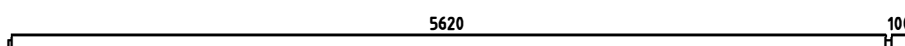
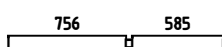

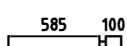
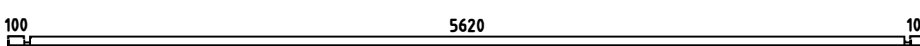

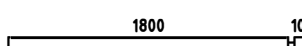

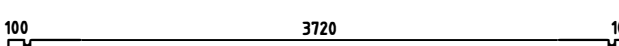
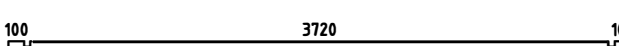
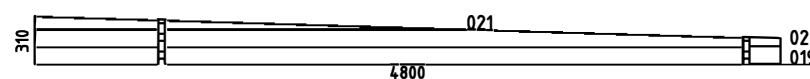
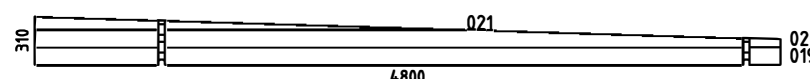
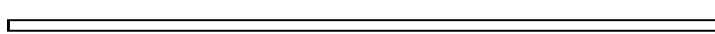
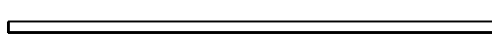







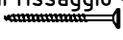
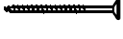

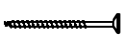
Terrace railing - Terrassenzaun - Garde-corps de terrasse
Ringhiera per terrazza - Terras rails (leuning) - Piiirdeaed

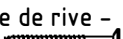
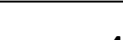
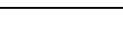
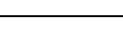
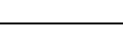
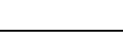

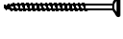
Pos	12.07.2019 Piece list - Stückliste - Liste des pièces - Elementi - Stuklijst - Tükitalabel Art. Nr. WC165002 10/13	Q	P (mm)	L (mm)
001		1	40x57	3734
002		1	40x57	564
003		1	40x114	3734
004		33	40x114	564
005		32	40x114	564
006		20	40x114	5900
007		2	40x114	820
008		2	40x114	5780
009		2	40x114	1381
010		14	40x114	585
011		2	40x114	725
012		1	40x57	5900
013		32	40x114	460
014		1	40x114	1940
015		1	40x114	1940
016		15	40x114	460
017		1	40x114	4000
018		20	40x114	4000
WA-1		1		
WB-1		1		
IAR1	Foundation - Fundament - Fondation - Fondamenta - Fundering - Immutatud alusraam 	4	45x70	4590
IAR3	Foundation - Fundament - Fondation - Fondamenta - Fundering - Immutatud alusraam 	24	45x70	3155
IAR2	Foundation - Fundament - Fondation - Fondamenta - Fundering - Immutatud alusraam 	4	45x70	481

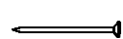

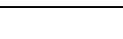
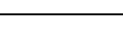

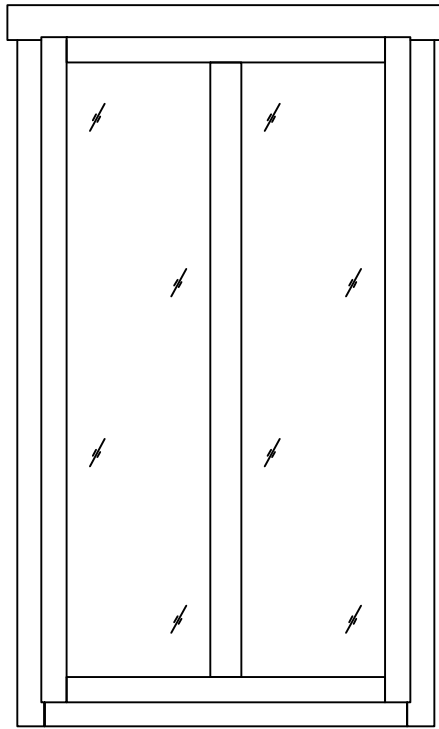

Pos	12.07.2019 Piece list - Stückliste - Liste des pièces - Elementi - Stuklijst - Tükital 11/13 Art. Nr. WC165002	Q	P (mm)	L (mm)
SR1	Rafter - Dachsparren - Chevron - Trave - Dak spar - Sarikas 	9	44x140	4806
	Floor boards - Fussbodenbretter - Lame de plancher - Pavimento - Vloerhout - Pörandalaud 	63	90x18	3716
	Terrace boards - Terrassenbretter - Plancher de terrasse - Piattaforme terrazzo - Terrasvloer - Terrasilaud 	9	90x19	4600
	Terrace boards - Terrassenbretter - Plancher de terrasse - Piattaforme terrazzo - Terrasvloer - Terrasilaud 	60	90x19	800
DB1	Roof boards - Dachbretter - Voliges - Perlina per tetto - Dakhout - Katuselaud 	54	90x18	3335
DB2	Roof boards - Dachbretter - Voliges - Perlina per tetto - Dakhout - Katuselaud 	54	90x18	3265
	Floor fillet - Fussbodenleiste - Corniere de finition du plancher - Finitura per pavimento (battisco pa) - Vloerafwerklijst - Pörandaliist 		18x18	18.66
DPL1	Roofing felt fillet - Dachpappenleiste - Baguette de fixation du feutre bitumeux - Asse per fissaggio guaina bituminosa - Afdekljst asfaltpapier - Katussepapiliist 	2	18x58	3300
DPL2	Roofing felt fillet - Dachpappenleiste - Baguette de fixation du feutre bitumeux - Asse per fissaggio guaina bituminosa - Afdekljst asfaltpapier - Katussepapiliist 	2	18x58	4807
PL1	Fillet for terrace railing - Leiste für terrasse - Baguette pour corps de terrasse - Massellino di guarnizione per ringhiera - Terras lijst - Päärde liist 	4	18x18	1943
PL2	Fillet for terrace railing - Leiste für terrasse - Baguette pour corps de terrasse - Massellino di guarnizione per ringhiera - Terras lijst - Päärde liist 	4	18x18	1997
PL4	Fillet for terrace railing - Leiste für terrasse - Baguette pour corps de terrasse - Massellino di guarnizione per ringhiera - Terras lijst - Päärde liist 	2	18x70	1943
PL5	Fillet for terrace railing - Leiste für terrasse - Baguette pour corps de terrasse - Massellino di guarnizione per ringhiera - Terras lijst - Päärde liist 	2	18x70	1997
PL3	Fillet for terrace railing - Leiste für terrasse - Baguette pour corps de terrasse - Massellino di guarnizione per ringhiera - Terras lijst - Päärde liist 	93	28x34	544
P1	Post - Pfosten - Poteau - Piede registrabile - Stijl - Post 	1	70x70	2000
P2	Post - Pfosten - Poteau - Piede registrabile - Stijl - Post 	1	70x70	2054
TB-1	Fascia board - Traufbrett - Bandeau de toit - Finitura lati tetto - Gevelliist - Räästalaud 	1	18x90	3265
TB-2	Fascia board - Traufbrett - Bandeau de toit - Finitura lati tetto - Gevelliist - Räästalaud 	1	18x90	3335
	Terrace edge board - Terrassenbrett, eingang - Lame de seuil d'entree de terrasse - Terrazzo uso abitacolo - Terrasvloer dorpel - Terrassi servaliist 	1	19x40	600
KFS-1	Storm protection - Sturmleiste - Latte anti-tempete - Protezione anti vento - Stormverankering / beveiliging - Tormikinnitusliist 	4	22x45	2500
BL	Fixing slat for distance spacers - Befestigungsleiste - Renforts planches de rives - Stecca per fissare i distanziatori - Bevestigingslat afstandhouders - Viilulaua kinnitus 	8	28x34	320
GL2	Gable moulding - Giebelleiste - Planche de rive - Finitura per frontale e retro del tetto - Gevelliist - Viilulaud 	3	18x120	3283
GL1	Gable moulding - Giebelleiste - Planche de rive - Finitura per frontale e retro del tetto - Gevelliist - Viilulaud 	3	18x120	3353

Pos	12.07.2019 Piece list – Stückliste – Liste des pièces – Elementi – Stuklijst – Tükitalabel Art. Nr. WC165002 12/13	Q	P (mm)	L (mm)
GL3	Gable moulding – Giebelleiste – Planche de rive – Finitura per frontale e retro del tetto – Gevellijst – Viilulaud 	6	18x120	4847
HS7	Screw for sliding wall tie – Schieberegler für wand – Sabot métallique pour fixation mur – Vite per fissare scorrimento a c su slitta fissata alla parete – Schuifdeur instellingen wand – Kruvi seinaliugurite 	16	3.5x20	
HS9	Screw for distance spacer fixing slat – Schrauben für befestigungs – leiste – Vis de fixation renforts planches de rives – Viti per distanziafore della stecca di fissaggio – Schroef voor afstand houder lat – Kruvi viilulaua kinnitusele 	10	3.5x50	
HS4	Screw for covering moulding – Schrauben für deckungsprofil – Vis de fixation profils horizontaux haut intérieur et extérieur d'encadrement de porte – Vite per cornice di copertura – Schroef voor afdekprofiel – Kruvi piirdelauale 	40	3x30	
HS14	Screw for fixing terrace railing – Schraube für terrasse – Vis de fixation de garde-corps de terrasse – Vite per fissaggio della ringhiera al terrazzo – Schroef voor terras – Kruvi piirdeaia kinnituseks 	10	4.5x80	
HS12	Screw for covering moulding – Schrauben für deckungsprofil – Vis de fixation profils horizontaux haut inférieur et extérieur d'encadrement de porte – Vite per cornice di copertura – Schroef voor afdekprofiel – Kruvi piirdelauale 	186	4x40	
HS12	Screw for fascia boards – Schrauben für traufbretter – Vis pour fixation bandeau de toit – Viti x striscia del tetto – Schroef voor gevellijst – Kruvi räästalauale 	24	4x40	
HS12	Screw for gable moulding – Schrauben für giebelleiste – Vis pour fixation planche de rive – Vite per fissare finiture davanti e dietro del tetto – Schroef voor gevellijst – Kruvi viilulauale 	96	4x40	
HS13	Screw for post – Schrauben für pfosten – Vis de fixation des poteaux – Viti per inviare – Schroef voor stijlen – Kruvi postile 	4	4x60	
HS18	Screw for rafter – Schrauben für dachsparren – Vis pour chevron – Vite per trave – Schroef voor dakspar – Kruvi sarikatele 	18	5x120	
HS18	Screw for gable – Schrauben für giebel – Vis pour fixation des pignons – Viti per timpano – Schroef voor gevelpunt – Kruvi viilude kinnitamiseks 	4	5x120	
HS16	Screw for 1. wall beam – Schraube für 1. bohlenreihe – Vis de fixations 1ere rangée de madriers avec poutrelles de fondations – Vite fissaggio alle fondamenta – Schroef voor 1 wandbalk – Kruvi poollauale 	10	5x90	
HS16	Screw for foundation – Schrauben zur befestigung fundament – Vis de fixations des poutrelles de fondations – Viti x fondamenta – Schroef voor fundering – Kruvi alusraamile 	56	5x90	
HS16	Screw for foundation – Schrauben zur befestigung fundament – Vis de fixations des poutrelles de fondations – Viti x fondamenta – Schroef voor fundering – Kruvi alusraamile 	17	5x90	
HS23	Screw for pos. 007-011; – Schrauben für pos. 007-011- Vis pour pos. 007-011 – Viti per fissare elemento vedi figura in pos. n.007-011 – Schroef voor pos. 007-011; – Kruvi pos. 007-011 	40	6x180	
HS19	Screw for sliding wall tie – Schieberegler für wand – Sabot métallique pour fixation mur – Vite per fissare scorrimento a c su slitta fissata alla parete – Schuifdeur instellingen wand – Kruvi seinaliugurite 	4	6x40	
HS20	Screw for post height adjustment – Schrauben für regulierungsschraube für pfosten – Vis de fixation de support réglable de poteau – Viti per fissare ed aggiustare l'altezza del palo verticale – Schroef voor hoogte instelling stijlen – Kruvi vajumispoldile 	16	6x50	
NF2	Zn nail for floor fillet – Zn nagel für fussbodenleiste – Pointe pour corniere de finition du plancher – Chiodi x fissaggio pavimento – Spijker(nagel) voor vloer afdeklijst – Nael põrandaliistule 	37	1.4x40	
SH40	Hammer block – Schlagholz – Calle de frappe – Blocco di legno da usare come cuscinetto quando si usa il martello – Slagklos – Löögiklots 	1		
SFS	Nut for storm protection – Schraubenmutter für sturmleiste – Ecrou pour latte anti-tempete – Dado x asta protezione vento – Moer voor stromverankering – Mutter tormikinnitusliistule 	8	D6	
NF3	Zn nail for terrace – Zn nagel für terrassenbretter – Pointe pour plancher de terrasse – Chiodo zincato per terrazza – Spijker(nagel) voor terrasvloer – Nael terrasilauale 	552	2.1x50	
NF4	Zn nail for roof – Zn nagel für dachbretter – Pointe pour fixation voliges de toit – Chiodi x perline tetto – Spijker(nagel) voor dakhout – Nael katuselauale 	656	2x50	
NF4	Zn nail for floor – Zn nagel für fussbodenbretter – Clous pour plancher – Chiodi x perline pavimento – Spijker(nagel) voor vloer – Nael põrandalauale 	512	2x50	

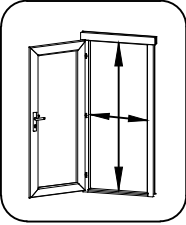
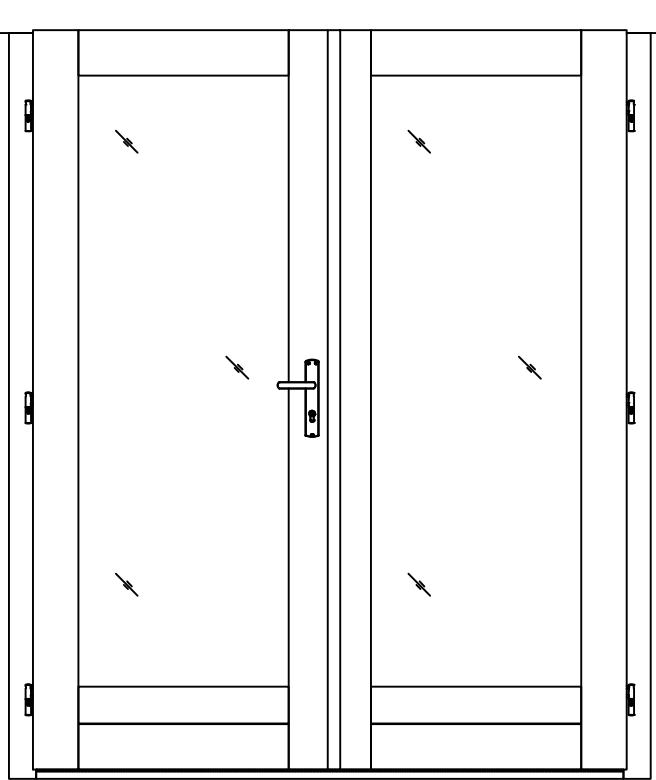
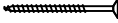
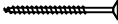
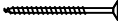
Pos	10.11.2017 Piece list - Stückliste - Liste des pièces - Elementi - Stuklijst - Tükítabel 1010x1780 TAK.1.100.TPM0.e DGP+	1/1	Q	P (mm)	L (mm)
-----	---	-----	---	-----------	-----------

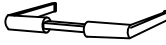
Glass size - Glasgröße - Taille de la vitre - Misura del vetro - Glas afmeting - Klaasi mõõt: 390x1602 mm



Pos	08.11.2018	Piece list - Stückliste - Liste des pièces - Elementi - Stuklijst - Tükitalabel 1588x1957 TUK.1.100.TPVV.MM DGP+	1/1	Q	P (mm)	L (mm)
	Glass size - Glasgröße - Taille de la vitre - Misura del vetro - Glas afmeting - Klaasi mõõt: 561x1593 mm				 1488x1873 mm	
						
HS4	Screw for door fillet - Schraube zur Befestigung türleiste - Vis pour fixation baguette d'arrêt de porte - Viti per massellino della porta - Schroef voor deurlijst - Kruvi ukse kokkuvaltšiliistule				5	3x30
HS16	Screw for door jamb - Schraube für Türrahmen - Vis de fixation partie haute avec montants du cadre de porte - Viti x fissaggio montanti porte - Schroef voor deurkozijn - Kruvi ukse lengile				4	5x90
HS25	Screw for doorstep - Schrauben für swelle - Vis pour fixation barre de seuil - Vite per soglia della porta - Schroef voor deurdorpel - Kruvi lävepakule				3	4.5x65
MH	Male bolt hinge for door - Türband - Partie male de paumelle de porte - Cerniera anube x porta - Scharnier bout - Reguleeritav polthing isane				6	14x80
HC	Covers for door hinges - Schutzkappe für Türband - Couverture de paumelle de porte - Copertura delle cerniere della porta - Afdek kap voor deurscharnier - Reguleeritava polthinge kate				12	
TL4	Door handle fittings - Türgriff - Poignée de porte - Maniglie - Deurhendel / klink - Ukse käepide				1	
TL5	Set of door lock covers - Schlossblenden - Set de garnitures de porte - Copertura serrature - Slot sluitplaat set - Ukse lukuplaat				1	
	Cylinder lock - Zylinderschloss - Barillet de porte - Serratura - Cylinder slot - Ukse lukusüdamik				1	30x35
	Striker for barrel bolt - Hülse für Grendelriegel - Gache au sol du targette - Boccola per fermo della porta - Huls voor vergrendelingsschuif - Vasturaud ukse servariivile				2	