

DANCOVER[®]

.com

Manual
Storage tent
4m Series PVC

DANCOVER[®]

.com

Safety Advice

Attention

In some countries approval is needed to set up a marquee/tent larger than 75 m². It is your responsibility to comply with local rules and regulations and to ensure that the marquee/tent is assembled correctly.

In case of bad weather conditions, it is your responsibility to ensure the marquee/tent is safely secured and that the marquee/tent does not cause damage to others.

Do not use open fire, welding equipment or other sources which can ignite, inside or close to the tent.

The marquee/tent must be safely secured. We recommend you secure your marquee/tent with straps and pegs as soon as it is assembled.

Make sure to check if the marquee/tent is covered by your home contents insurance.

Marquees/tents must be evacuated under extreme weather conditions.

In the event of snow always remove snow from the roof of the marquee/tent regularly to prevent snow from building on the roof as heavy snow can cause the marquee/tent to collapse.

In the event of rain there is a risk of rain puddles building up on top of the roof of the marquee/tent. Heavy rain puddles can cause the roof to collapse. It is your responsibility to ensure rain puddles do not build up. As a precaution, make sure the roof of the marquee/tent is stretched out properly and adequately over the side frames of the marquee/tent and remove rain water regularly.

Do not unpack or repack your marquee/tent in freezing temperatures. In case of temperatures below zero always unpack and repack your marquee/tent indoors to avoid the risk of cracking parts.

The marquee/tent must be totally dry before you repack and store it to avoid mildew.

Note: Marquees are intended for events and other arrangements and are as such only meant for short term temporary assembly and the following disassembly. Dancover warranty applies only to the normal use of the Product, normal wear and tear excepted, in accordance with written use instructions or manual. The warranty does not apply to damage caused by accident, abuse, misuse, or modification of the Product.

Warranty Information

Please visit dancovershop.com for information on warranty.









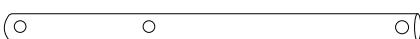
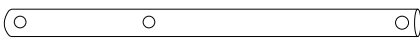
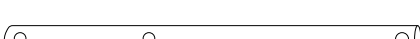
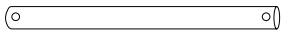

Please always check our website for the latest safety advice and manual.

Warning

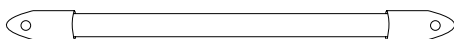
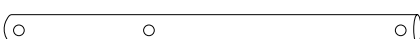

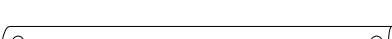

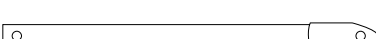



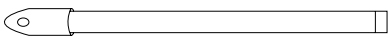

1. In order to avoid being rusted by air, oil is covered on the surface of the pipes, before set up the tent, please remove the oil carefully first to keep the cover clean.
2. Take note that the tent needs to be handled carefully to avoid damage.
3. Do not force the frame as they may be damaged in the process.
4. Tents are meant as temporary shelter and must be evacuated under extreme weather conditions.

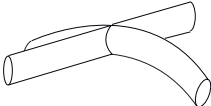
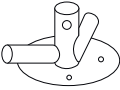
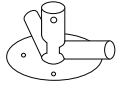
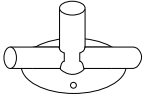
Please select a suitable site for the tent to avoid the damage to underground sprinkler systems, water, gas or electrical lines.

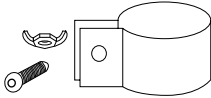
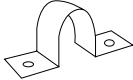



4m Storagetent manual

Part No.			4x4m	4x6m	4x8m	4x10m	4x12m
1	Middle leg 1880mm Ø50		2	4	6	8	10
2	Frame pole 1880mm Ø38		6	11	16	21	26
3-1	Frame pole 1880mm Ø38		2	2	2	2	2
3-2	Frame pole 1880mm Ø38		2	2	2	2	2
4	Frame pole 2030mm Ø50		6	8	10	12	14
5	Groundbar pipe		4	4	4	4	4
6	Diagonal support 1174mm Ø25		4	4	4	4	4
7	Roof support 1652mm Ø25		3	4	5	6	7
8	Corner leg 1880mm Ø50		4	4	4	4	4
9	Male doorbar		2	2	2	2	2
10	Female doorbar		2	2	2	2	2
11	Pillar		4	4	4	4	4
12	Pillar		4	4	4	4	4
13	Ceiling rail		2	2	2	2	2

4m Storagetent manual

Part No.			4x4m	4x6m	4x8m	4x10m	4x12m
14	Ceiling rail		2	2	2	2	2
15-1	3-way connector 54-42mm (A)		6	6	6	6	6
15-2	4-way connector 54-42mm (B)		3	6	9	12	15
16	3-way connector for corner		2	2	2	2	2
17	3-way connector for corner		2	2	2	2	2
18	3-way connector for sidewall		6	8	10	12	14
23	Strengthen bar		4	6	8	10	12
24	Bracket		10	12	14	16	18
25	Groundbracket		4	6	8	10	12
26	Peg 400mm		8	12	16	20	24
27	Spiral peg		4	4	4	4	4
28	Long peg		10	12	14	16	18
29	Small peg		28	32	36	40	44
30	Bungeeball long		44	44	44	44	44
31	Rope		4	4	4	4	4

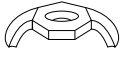
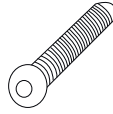
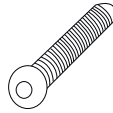
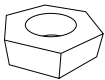
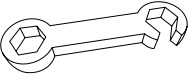
4m Storagetent manual

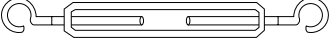
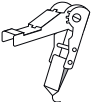
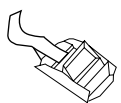
Part No.			4x4m	4x6m	4x8m	4x10m	4x12m
32	Screw M6x30		8	10	12	14	16
33	Screw M6x45		5	5	5	5	5
35	M6 wingnut		13	15	17	19	21
37	Screw M8x50mm		40	50	60	66	80
38	Screw M8x60mm		38	46	54	64	70
39	M8 nut		78	96	114	130	150
40	Spanner		1	1	1	1	1
41	Steel tension bar		8	12	16	20	24
42	Turnbuckle		4	6	8	10	12
43	Tie down		4	4	4	4	4
44	Steel clip		16	20	24	30	32
45	Roof		1	1	1	1	1
46	Endwall		2	2	2	2	2

I

Select a flat ground for the tent, unpack the carton and check all the parts including tubes, tent and accessories... etc. are present and the same as the list.

Assemble the framework of rooftop by joining the portion (15-1.15-2) together with poles (2.3-1.3-2.4) NO.3 is on four corners for diagonal pipe

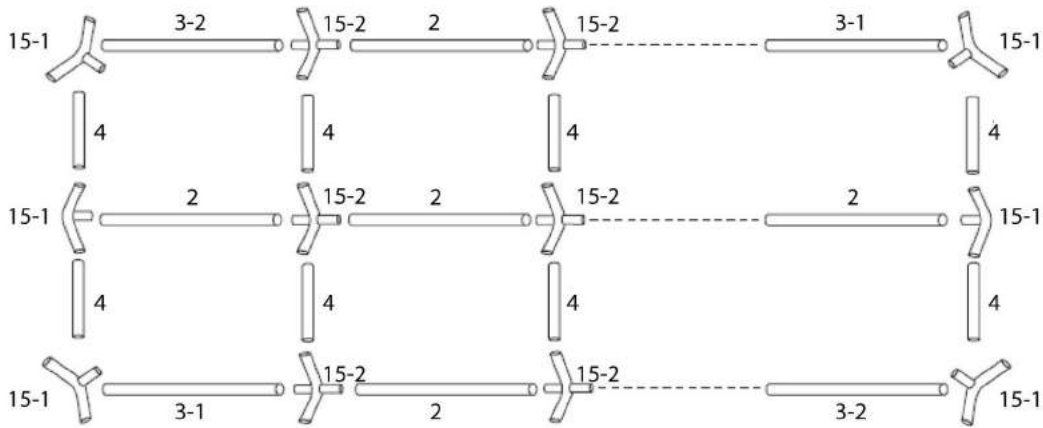

II

To ensure the screw fixed to every pole tightly. And then use the turnbuckle and steel tension bar to tighten the top structure.

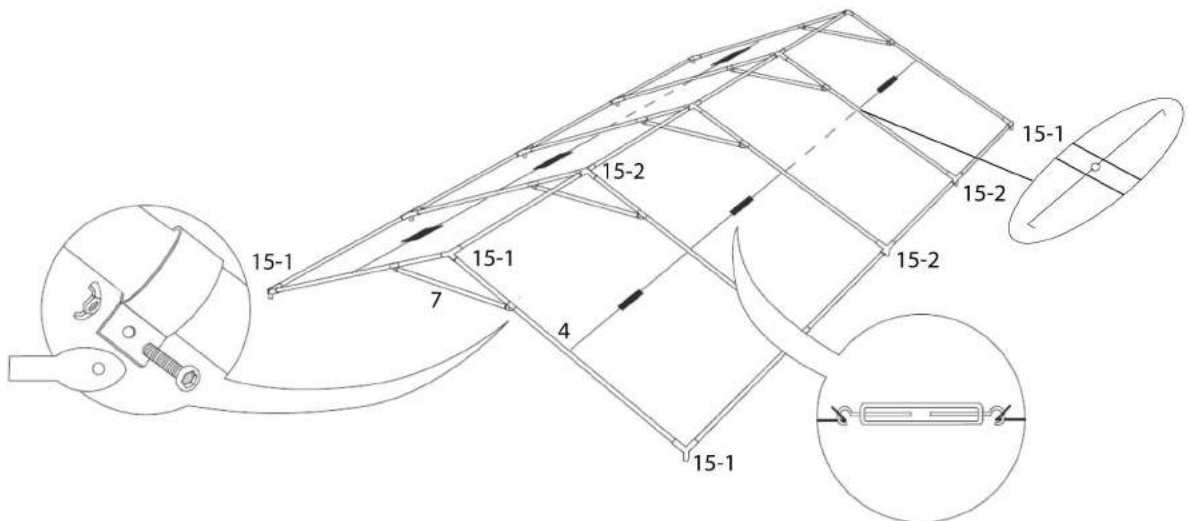

III

Attach one end of supported pole (1.8) to the joints

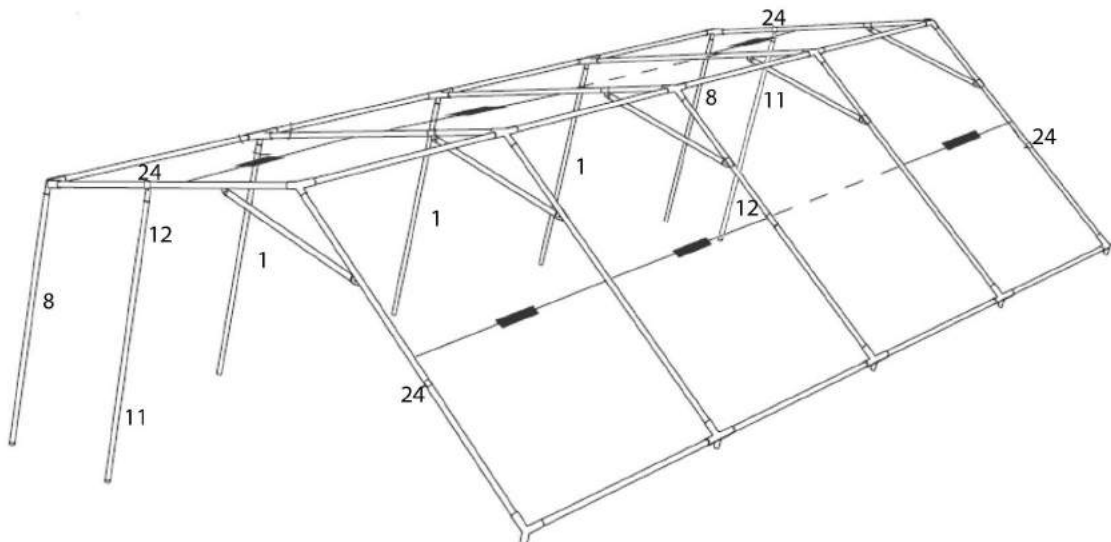

IV

Attach the another supported poles (1.8) to the joints, built-up the framework.

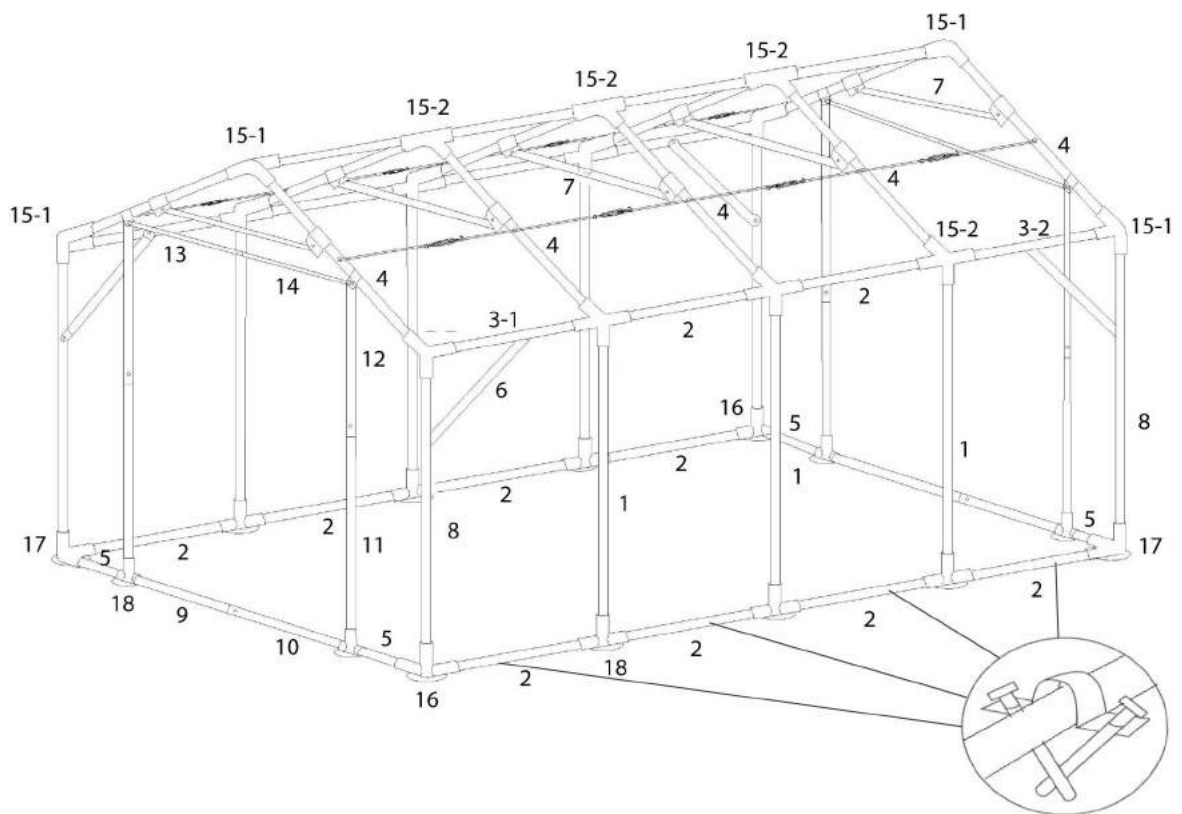

V

You facilitate the assembly and dismantling by pulling the roof with ropes on tent frame. Use the steel clips to fasten the cover to the frame. Each section we offer bracket and nail to fasten the frame to ground.

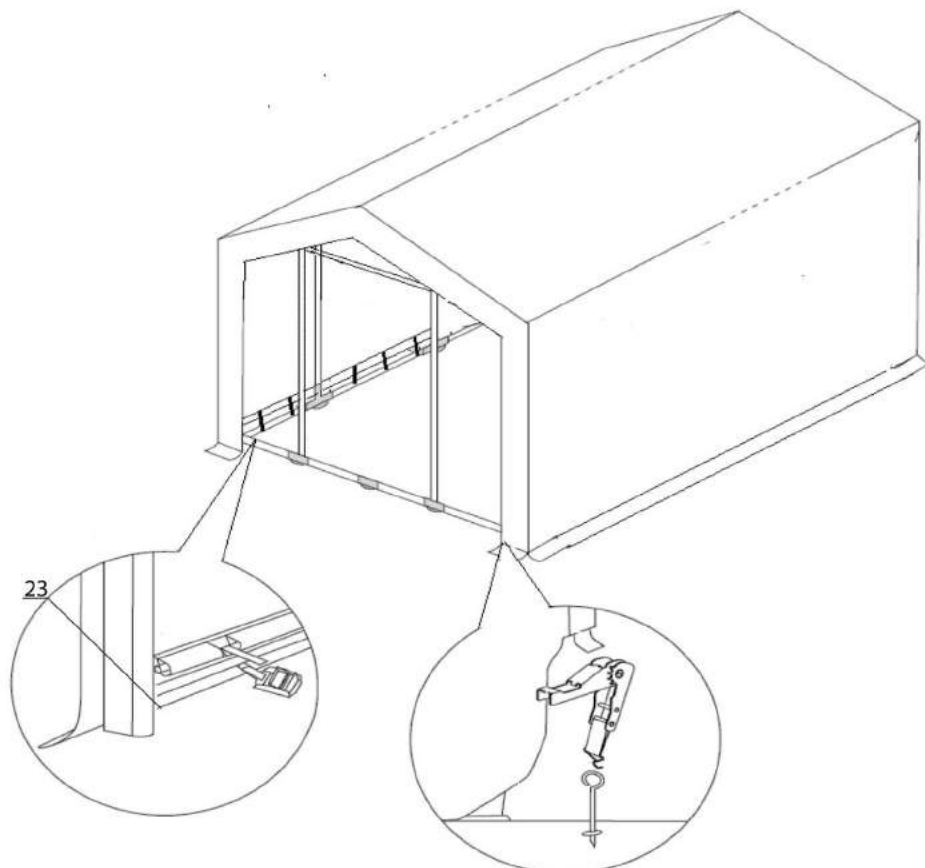

VI

Spread the wall panel and door panel attach to framework by using the bungee cords clasp the frame to grommets that is construct over the wall panel and door panel to ensure stability. Also use the short pegs to fix the doors to the ground.

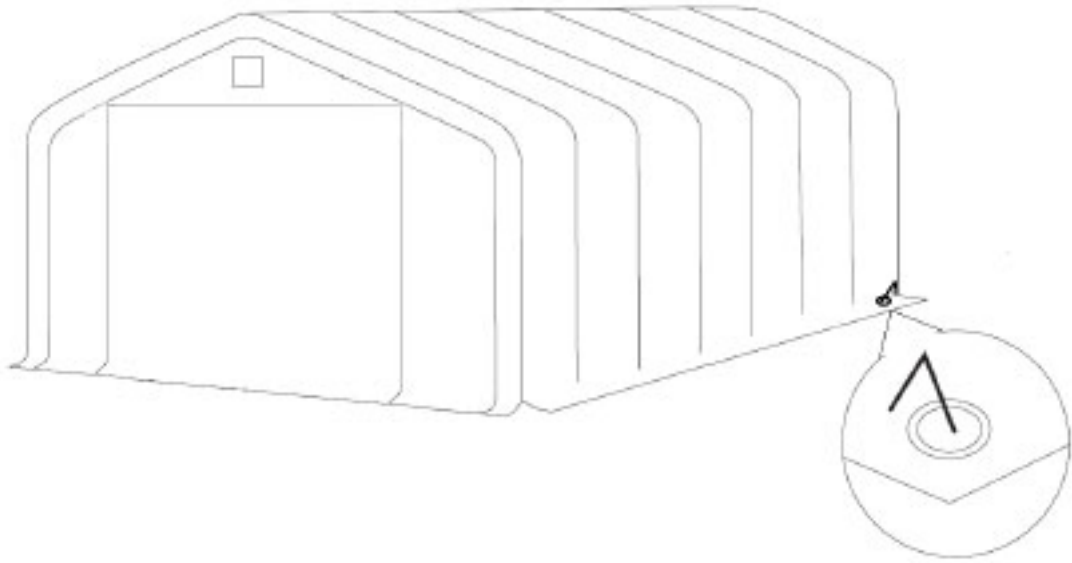

DANCOVER[®]



Contact information

Head office:

Dancover A/S
Nordre Strandvej 119 G
3150 Hellebæk
Denmark

For more information
please visit:
www.dancovershop.com

National contact

Denmark: 70 26 76 20
denmark@dancover.com

UK: 020 8099 7570
uk@dancover.com

Germany: 041 0266 7040
germany@dancover.com

France: 0975 181 800
france@dancover.com

Sweden: 040 233 262
sverige@dancover.com

Finland: 0 931 581 720
suomi@dancover.com

Poland: 22 300 8602
polska@dancover.com

Luxembourg: +49 041 0266 7040
luxembourg@dancover.com

Portugal: 308 800 899
portugal@dancover.com

Spain: 911 436 828
espana@dancover.com

Italy: 02 479 21 198
italia@dancover.com

Switzerland: 0840 000125
schweiz@dancover.com

Austria: 0662 626935
austria@dancover.com

Norway: 231 00 690
norge@dancover.com

Nederland: 0 858 880 524
nederland@dancover.com

Ireland: 0 151 33 003
ireland@dancover.com

Belgium: 0 28 08 08 09
belgique@dancover.com