

DANCOVER[®]

.com

Manual

Storage tent PRO

6m PVC/PE Series

DANCOVER[®]

.com

Safety Advice

Attention

In some countries approval is needed to set up a marquee/tent larger than 75 m². It is your responsibility to comply with local rules and regulations and to ensure that the marquee/tent is assembled correctly.

In case of bad weather conditions, it is your responsibility to ensure the marquee/tent is safely secured and that the marquee/tent does not cause damage to others.

Do not use open fire, welding equipment or other sources which can ignite, inside or close to the tent.

The marquee/tent must be safely secured. We recommend you secure your marquee/tent with straps and pegs as soon as it is assembled.

Make sure to check if the marquee/tent is covered by your home contents insurance.













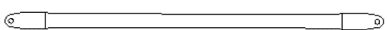
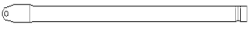

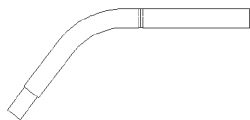
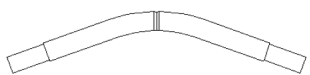
Marquees/tents must be evacuated under extreme weather conditions.







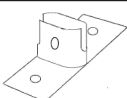
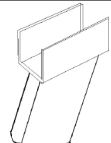







In the event of snow always remove snow from the roof of the marquee/tent regularly to prevent snow from building on the roof as heavy snow can cause the marquee/tent to collapse.

In the event of rain there is a risk of rain puddles building up on top of the roof of the marquee/tent. Heavy rain puddles can cause the roof to collapse. It is your responsibility to ensure rain puddles do not build up. As a precaution, make sure the roof of the marquee/tent is stretched out properly and adequately over the side frames of the marquee/tent and remove rain water regularly.

Please always check our website for the latest safety advice and manual.

Part list

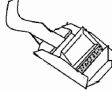
			6x6	6x12	6x18
1	Back leg		4	6	8
2	Back leg		8	16	24
3	Crossbar		8	16	24
4	Ceiling rail		6	11	16
5	Ceiling rail		6	11	16
6	Extension pipe		4	4	4
7	Corner arch		12	22	32
8	Center arch		6	11	16
9	Connecting pipe		44	99	154
10	Connecting pipe		11	11	11
11	Extension pipe		8	18	28
12	Door Pillar		4	4	4
13	Door pillar		4	4	4
14	Cross bar		8	8	8
15	Fastening bar		10	20	30
16	Foot base		16	26	36
17	Connecting component		4	4	4
18	Peg 10x305mm		8	16	24

19	Peg 6x180mm		34	60	78
20	Peg 8x300mm		24	44	64
21	Spiral peg 10x400mm		4	4	4
22	1.75" Screw		6	11	16
23	2.5" Screw		12	22	32
24	4" Screw		70	124	180
25	Wingnut		88	157	228
26	Floor Bracket (set of 2 pcs)		4	8	12
27	Bungee ball		96	96	96
28	Spanner		2	2	2
29	Bolt with nut		16	26	36
30	Tie-down kit		4	4	4
31	Steel clip		20	40	60
32	Rope		4	4	4
33	Rope		2	2	2

07-08-2013

Attention

Please use gloves when assembling the metal frame portion of this unit. The metal components of this products have been treated,with a rust preventive coating that may feel oily to the touch. This coating is not dangerous, but may dirty your hands during assembly. We recommend that you wipe the metal parts clean with a mixture of warm water and dish detergent prior to assembly. Should your hands become dirty, simply wash with soap and water.

After the whole frames are set up, they should be the same as the pictures below.

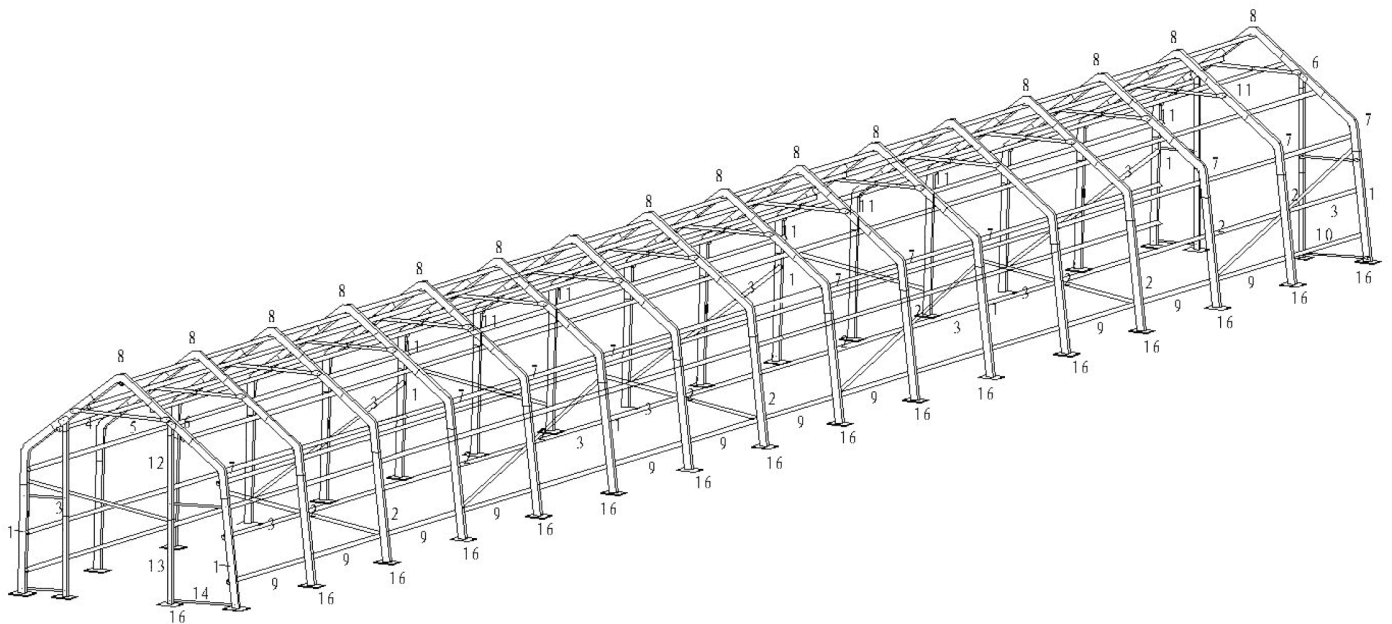
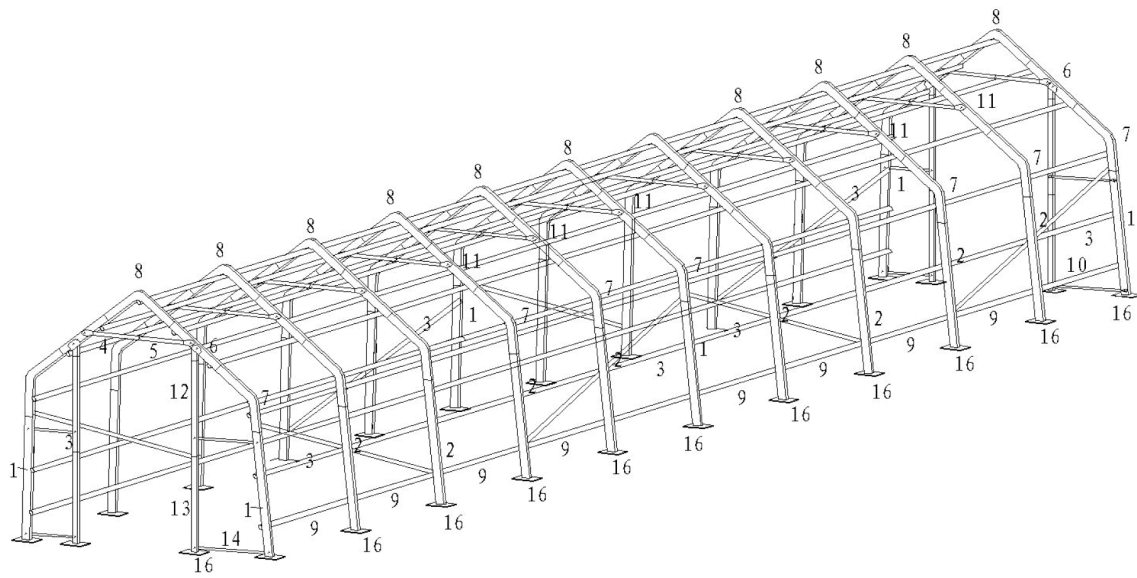
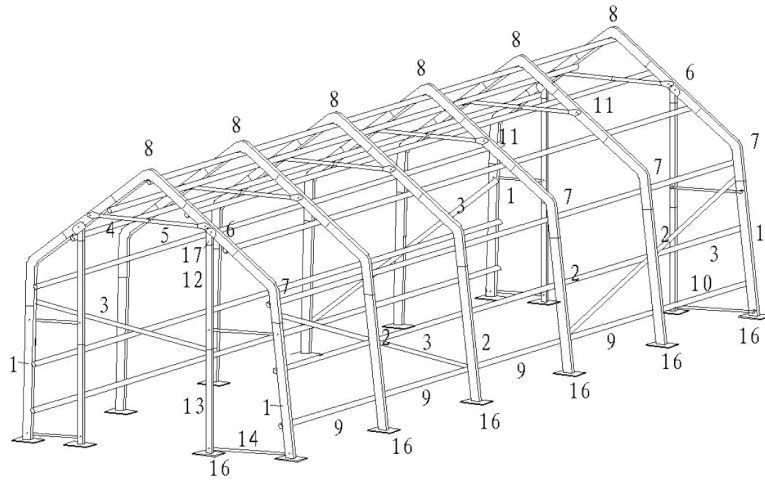

Please assemble the frame as below steps. They have similar assemble steps. Here we take 6x6 for example .

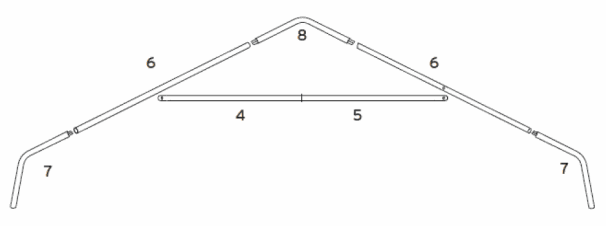
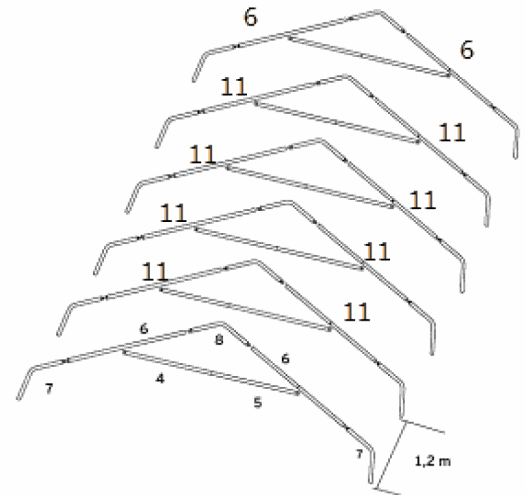
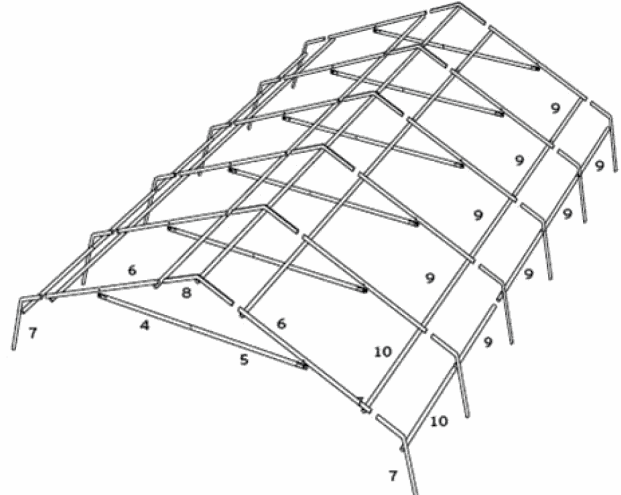
<p>Step 1 When assembling the tent, make sure that all the wingnuts are attached to the inside. Connect one center arch pipe(8) with the extension pipe Attached the corner arch(7) to the ends of the extension pipe(6). Now connect the ceiling rail(4 and 5) with each other using the 1.75"(22) screw and the wingnuts(25). Connect the ceiling rail with respective extension pipe(6) using the 2.5"(23) screws and wingnuts(25).</p>	
<p>Step 2 Repeat step 1 for the next 5/10/15 elements to place them on the ground one after another, as illustrated. Attention: all elements with extension pipe no.6 need to be placed at the ends. Extension pipe no.6 has holes for door pillar.</p>	
<p>Step 3 Now connect the 6 arch elements with each other using the connecting pipes (9 and 10). Not that only corner arch 10 are used for the front segments. Use the 4"(24) screw and wingnut(25) to tighten them.</p>	

Step 4

Start setting up one side first. Connect the corner arches(7) to the legs (1 and 2). Secure the frame using the connecting pipes(9 and 10). Attach the diagonal pipes(3) to the back legs(1). Please refer to the complete frame pictures to attach the diagonal pipes.

Tighten the tent at the feet using the 4" screws(24) and the wingnuts(25).

Use the floor bracket(26) and the pegs 10x305mm(18) to fasten the frame to the ground.

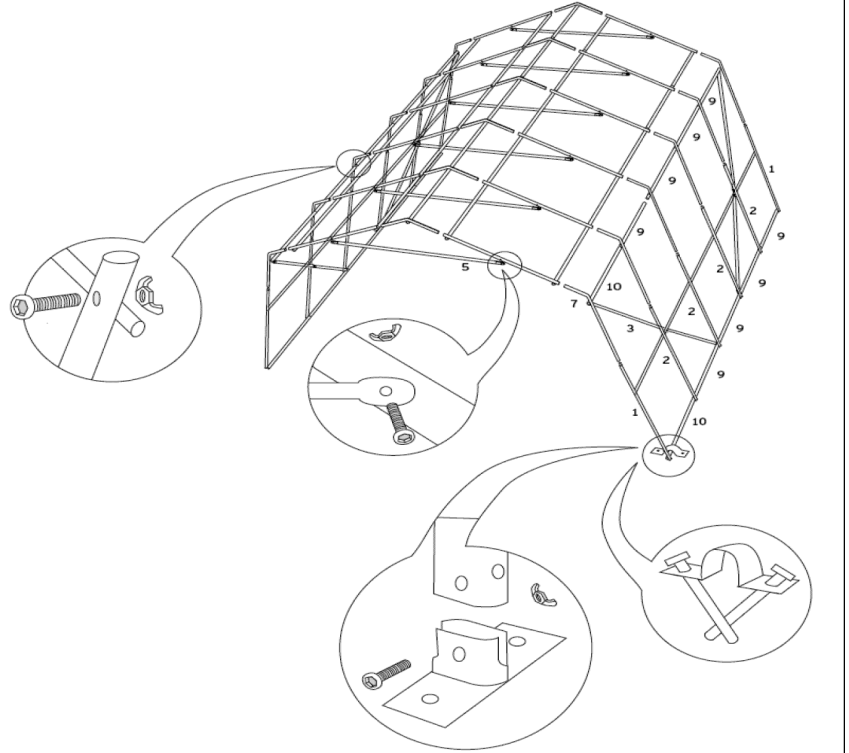

Step 5

Unfold the tent cover and put it over the frame. Insert the fastening bar into the loop at the lower end of the rood and fasten it with steel clips(31). Attach the endwall to the fram using the bungees. Tension the roof cover to the tent frame to the ground using pegs 8x300mm(20)

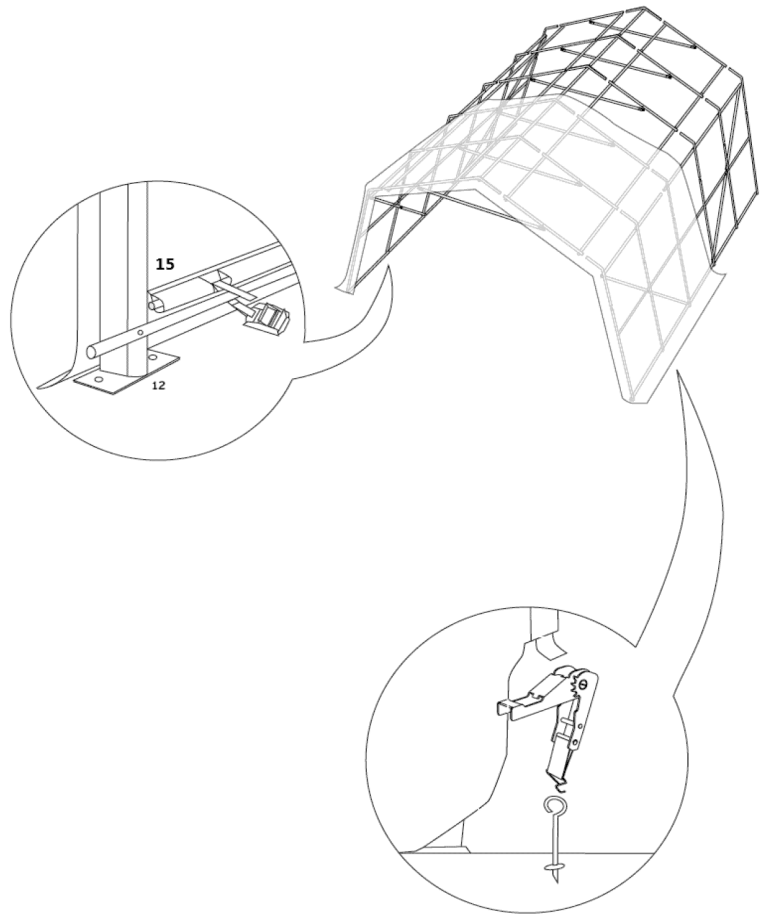

Step 6

Assemble the pillar set like below picture .

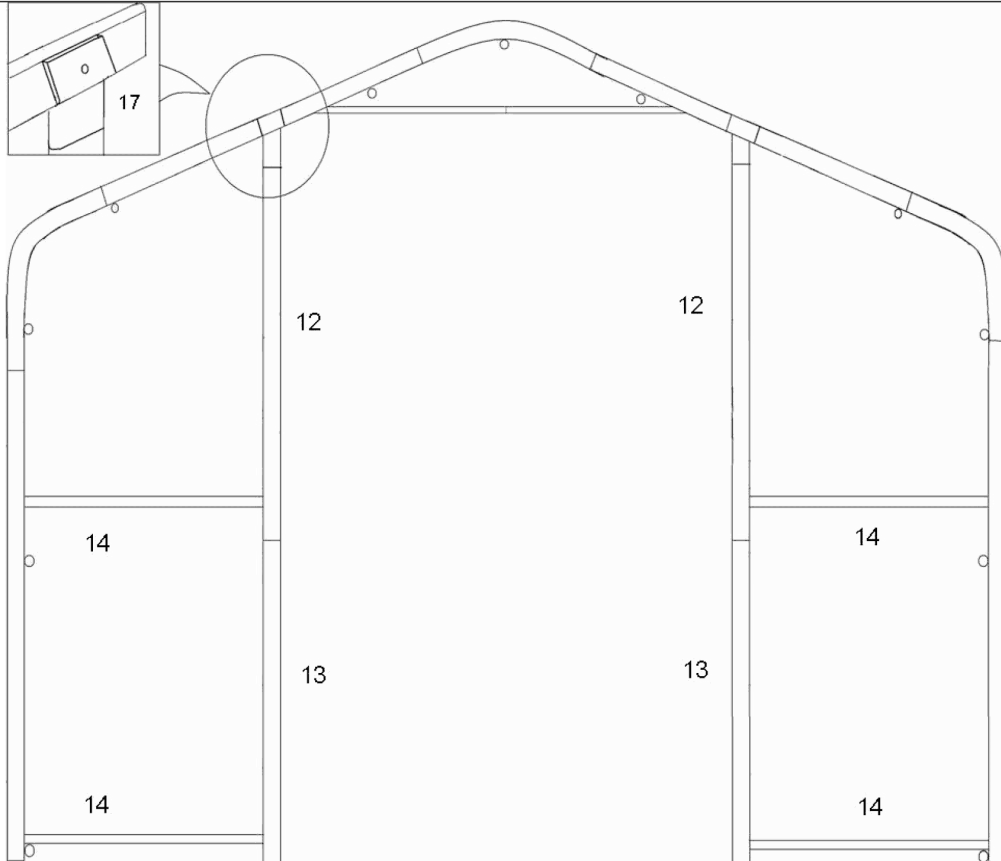

Step 7

Use ropes to attach the door and cover the the frame. To find a proper way and strength to attach the cover to frame carefully. Please do not use too much strength to tear the eyelet out of fabric

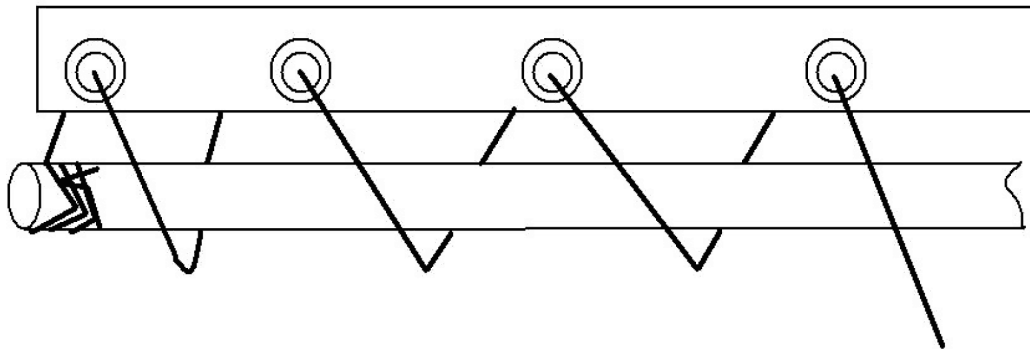

Contact information

Head office:

Dancover A/S
Nordre Strandvej 119 G
3150 Hellebæk
Denmark

For more information
please visit:
www.dancovershop.com

National contact

Denmark:

denmark@dancover.com

UK:

uk@dancover.com

Germany:

germany@dancover.com

France:

france@dancover.com

Sweden:

sverige@dancover.com

Finland:

suomi@dancover.com

Poland:

polska@dancover.com

Luxembourg:

luxembourg@dancover.com

Spain:

espana@dancover.com

Italy:

italia@dancover.com

Switzerland:

schweiz@dancover.com

Austria:

austria@dancover.com

Norway:

norge@dancover.com

Nederland:

nederland@dancover.com

Ireland:

ireland@dancover.com

Belgium:

belgique@dancover.com