

DANCOVER[®]

.com

Manual
Storage tent PRO
8x12x4,4m PVC

DANCOVER[®]

.com

Safety Advice

Attention

In some countries approval is needed to set up a marquee/tent larger than 75 m². It is your responsibility to comply with local rules and regulations and to ensure that the marquee/tent is assembled correctly.

In case of bad weather conditions, it is your responsibility to ensure the marquee/tent is safely secured and that the marquee/tent does not cause damage to others.

Do not use open fire, welding equipment or other sources which can ignite, inside or close to the tent.

The marquee/tent must be safely secured. We recommend you secure your marquee/tent with straps and pegs as soon as it is assembled.

Make sure to check if the marquee/tent is covered by your home contents insurance.

Marquees/tents must be evacuated under extreme weather conditions.

In the event of snow always remove snow from the roof of the marquee/tent regularly to prevent snow from building on the roof as heavy snow can cause the marquee/tent to collapse.

In the event of rain there is a risk of rain puddles building up on top of the roof of the marquee/tent. Heavy rain puddles can cause the roof to collapse. It is your responsibility to ensure rain puddles do not build up. As a precaution, make sure the roof of the marquee/tent is stretched out properly and adequately over the side frames of the marquee/tent and remove rain water regularly.

Do not unpack or repack your marquee/tent in freezing temperatures. In case of temperatures below zero always unpack and repack your marquee/tent indoors to avoid the risk of cracking parts.

The marquee/tent must be totally dry before you repack and store it to avoid mildew.







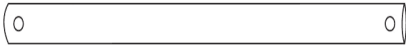

This structure is not tested for snow and wind loads. We always recommend that you remove snow from the roof. This is a none-permanent structure.

Warranty Information

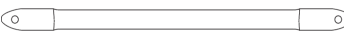
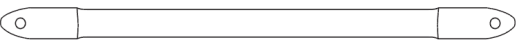
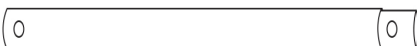

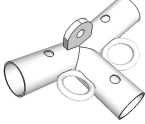
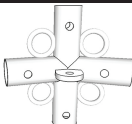
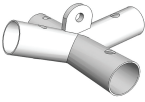

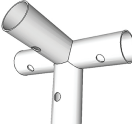
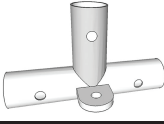
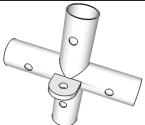

Please visit dancovershop.com for information on warranty.

Please always check our website for the latest safety advice and manual.

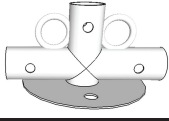
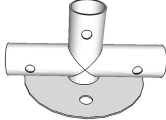
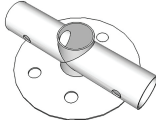

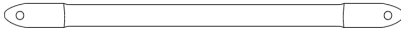
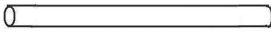
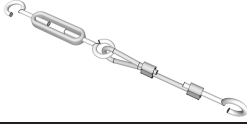
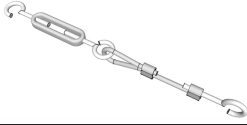

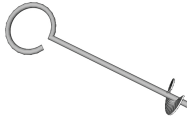

8x12 Storage Tent

| Description | Part number | | Quantity |
|--|-------------|--|----------|
| Bottom Leg 1455mm ø50 | 1 |  | 14 |
| Pipe 1880mm ø38 | 2 |  | 50 |
| Pipe 1950mm ø50 | 3 |  | 28 |
| Pipe 750mm roof enforcement vertical | 4 |  | 7 |
| Pipe 1980mm roof enforcement horizontal | 5 |  | 14 |
| Top Leg 1508mm ø50 | 6 |  | 14 |
| 3-way connector for corner 110°, 54-42mm with rings | 7 |  | 4 |
| 3-way connector for gabel roof top 140°, 54-42mm with rings and flange | 8 |  | 2 |
| 4-way connector roof top 140°, 54-42mm with rings and flange | 9-1 |  | 2 |
| 4-way connector roof top 140°, 54-42mm with flange | 9-2 |  | 3 |
| 4-way connector roof-leg 110°, 54-42mm with rings | 10-1 |  | 4 |
| 4-way connector roof-leg 110°, 54-42mm | 10-2 |  | 6 |
| 3-way connector flat roof, 54-42mm with flange | 11 |  | 4 |
| 4-way connector flat roof, 54-42mm with flange | 12 |  | 10 |
| Footbase 3-way right connector for corner with 1 ring | 13 |  | 2 |

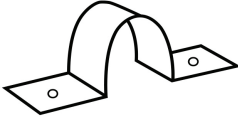
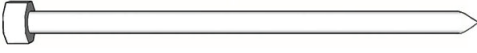
8x12 Storage Tent

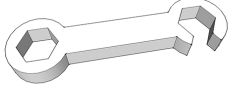
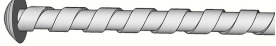
| | | | |
|--|------|--|----|
| Footbase 3-way Left connector for corner with 1 ring | 14 |  | 2 |
| Footbase 3-way connector flat for side with rings | 15-1 |  | 4 |
| Footbase 3-way connector flat for side | 15-2 |  | 10 |
| Footbase 2-way connector flat for gable | 16 |  | 2 |
| Bottom door pillar ø50 | 20 |  | 4 |
| Top door pillar ø50 | 21 |  | 4 |
| Pillar rail | 22 |  | 4 |
| Tension bar for roof cover | 23 |  | 12 |
| Steelwire buckle set for side | 24 |  | 8 |
| Steelwire buckle set for roof | 25 |  | 12 |
| Bungee | 26 |  | 90 |
| Spiral peg | 27 |  | 4 |
| Large peg 8x300mm | 28 |  | 20 |
| Small peg 4x180mm | 29 |  | 48 |

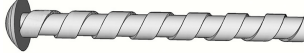
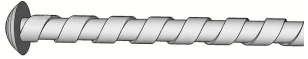
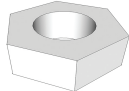
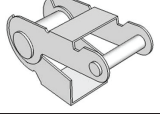
8x12 Storage Tent

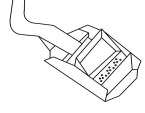
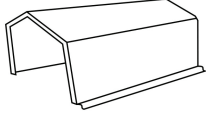
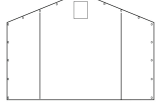
| | | | |
|---------------------------|----|--|-----|
| Floor bracket | 30 |  | 12 |
| Nail 40cm | 31 |  | 24 |
| rope 5m | 32 |  | 4 |
| Spanner | 33 |  | 1 |
| Screw M6x30mm | 34 |  | 28 |
| Wing nut M6 | 35 |  | 28 |
| Screw M8x50mm | 36 |  | 102 |
| Screw M8x60mm | 37 |  | 108 |
| Nut M8 | 38 |  | 214 |
| Tie down ratchet | 39 |  | 4 |
| Rope for pillar rails 10m | 40 |  | 4 |
| Steel clip | 41 |  | 36 |
| Roof | 42 |  | 1 |
| End wall | 43 |  | 2 |

8x12m Storage Tent

I

Select a flat ground for the tent, unpack the carton and check all the parts including tubes, tent and accessories... etc. are present as same as list.

Assemble the framework of rooftop by joining the portion (7.8.9.10.11.12.) together with poles (2.3). To ensure the screw fixed to every pole tightly.

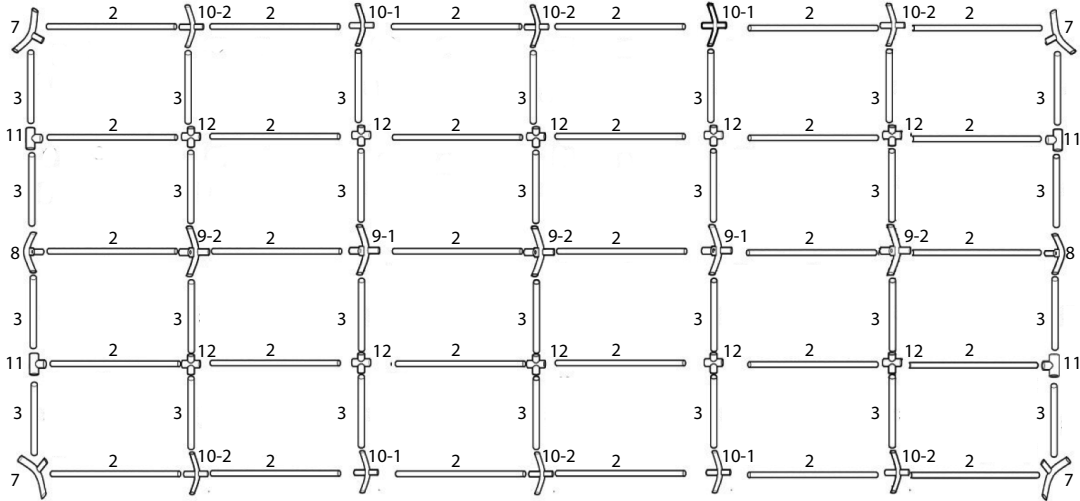

II

Attach one end of supported pole (4.5) to the joints (8.11.9.12)

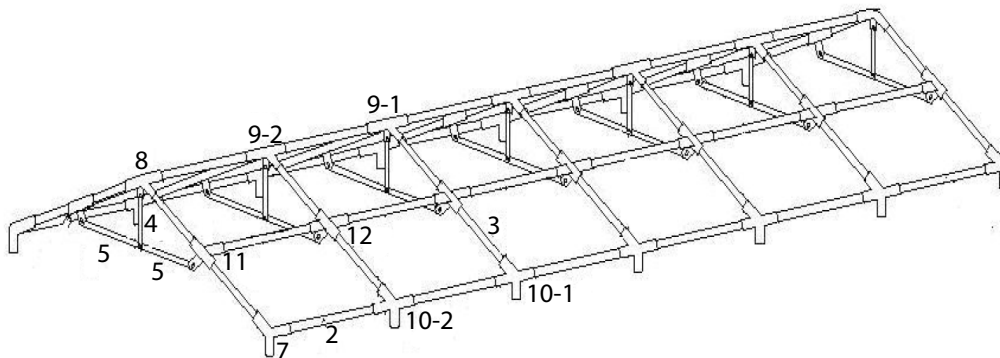

Fastening the roof by using turnbuckle set (25) which are diagonally across through each two sections as shown below.

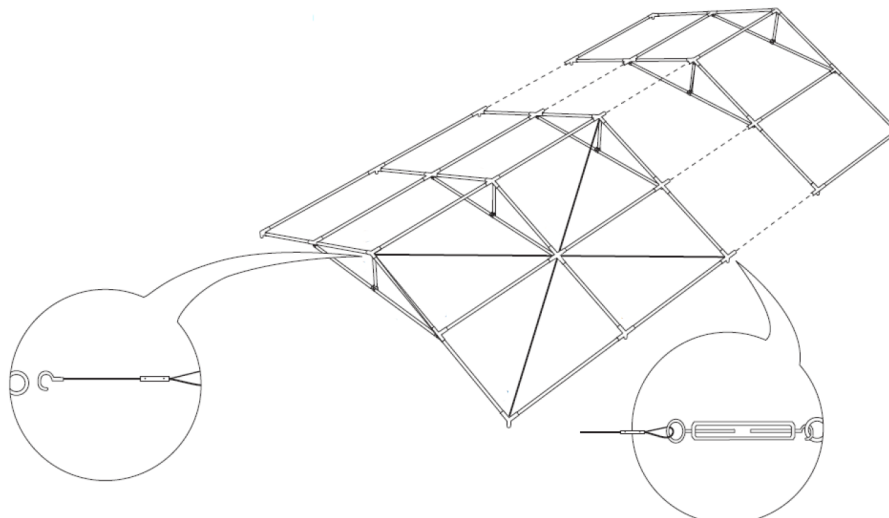

8x12m Storage Tent

III

Attach 7 pcs legs (no.6) to raise the tent on one side, then the other 7 pcs legs (no.6) on the other side. And repeat this step to fix the other 14 pcs legs. Use steel wires to complete the structure like below. Fix the ground bar and pillars like shown on the picture below.

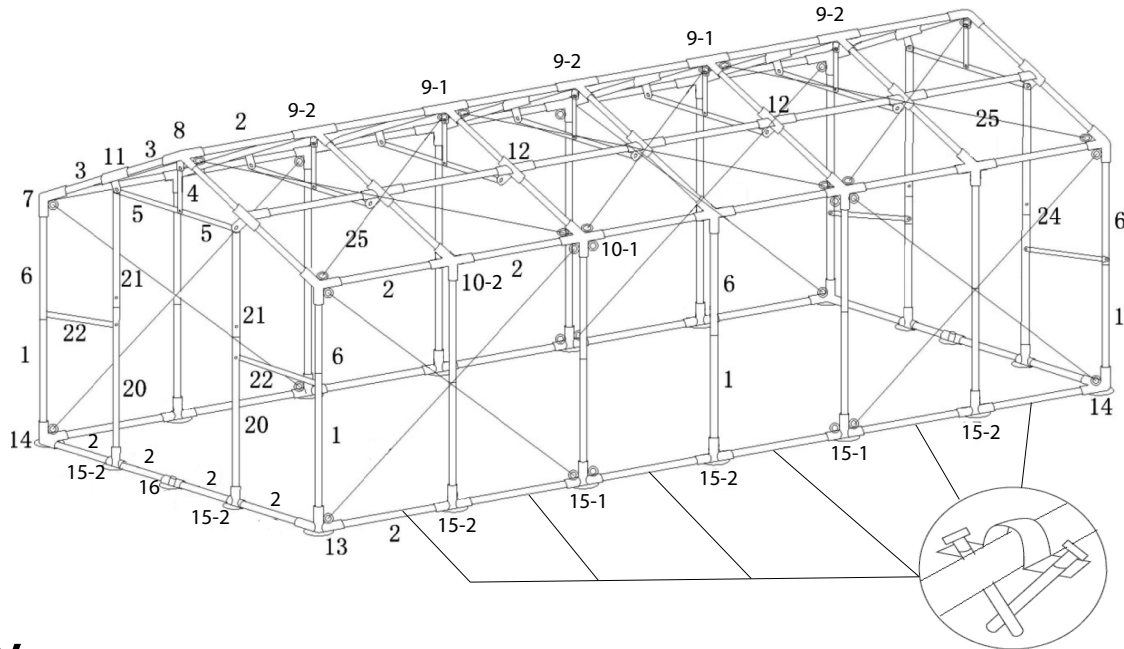

IV

You facilitate the assembly and dismantling by pulling the roof with ropes over the tent frame. steel clips to fasten the cover to the frame. In each section use brackets and nails to fasten the frame to the ground.

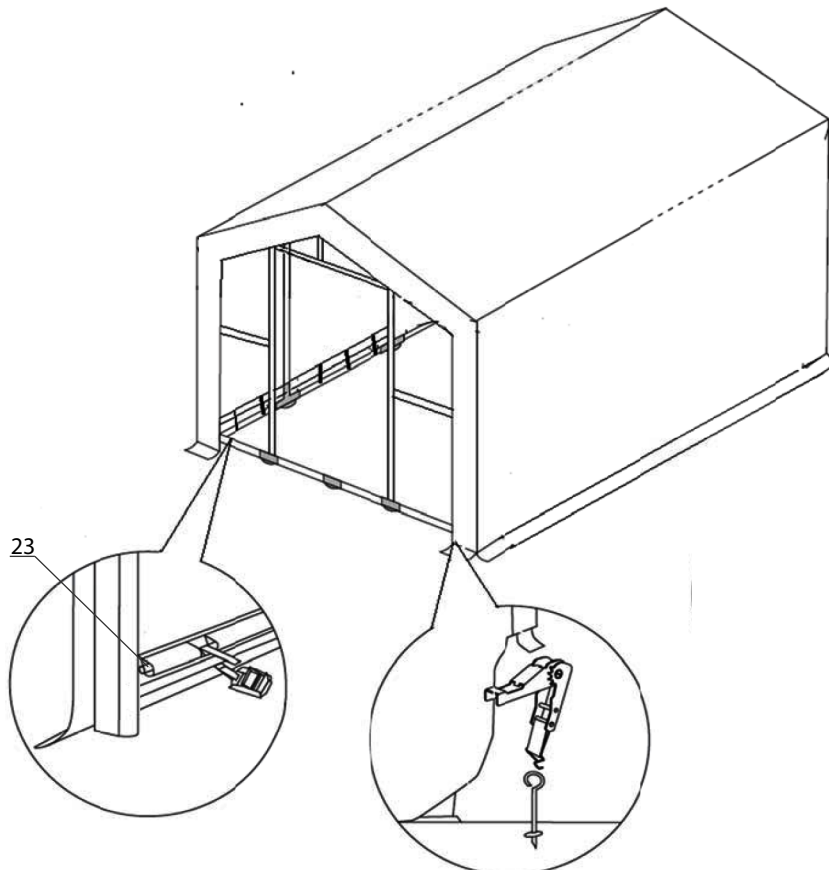

8x12m Storage Tent

V

Spread the wall panel and door panel attach to framework by using the bungee cords clasp the frame to grommets that is construct over the wall panel and door panel to ensure stability. Also use the short pegs to fix the doors to the ground.

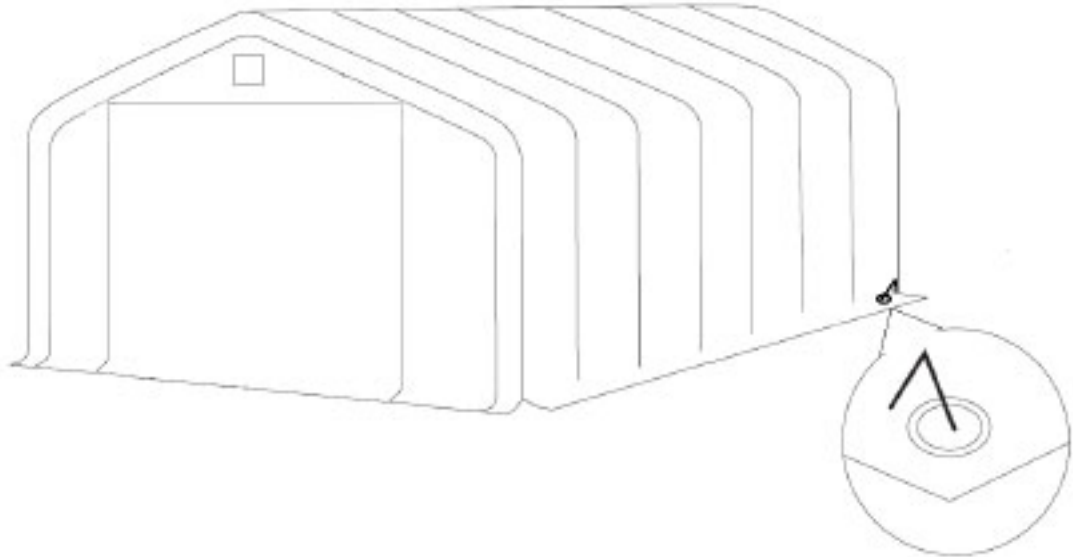

Warning

1. In order to avoid being rusted by air, oil is covered on the surface of the pipes, before set up the tent, please remove the oil carefully first to keep the cover clean.
2. Take note that the tent needs to be handled carefully to avoid damage.
3. Do not force the frame as they may be damaged in the process.
4. Tents are meant as temporary shelter and must be evacuated under extreme weather conditions.

Please select a suitable site for the tent to avoid the damage to underground sprinkler systems, water, gas or electrical lines.

Contact information

Head office:

Dancover A/S
Nordre Strandvej 119 G
3150 Hellebæk
Denmark

For more information
please visit:
www.dancovershop.com

National contact

Denmark:

denmark@dancover.com

UK:

uk@dancover.com

Germany:

germany@dancover.com

France:

france@dancover.com

Sweden:

sverige@dancover.com

Finland:

suomi@dancover.com

Poland:

polska@dancover.com

Luxembourg:

luxembourg@dancover.com

Spain:

espana@dancover.com

Italy:

italia@dancover.com

Switzerland:

schweiz@dancover.com

Austria:

austria@dancover.com

Norway:

norge@dancover.com

Nederland:

nederland@dancover.com

Ireland:

ireland@dancover.com

Belgium:

belgique@dancover.com