

**DANCOVER<sup>®</sup>**

**.com**

Manual  
for  
Chicken Coop  
1,4x1,25x1,12m

# Chicken Coop

## Manual

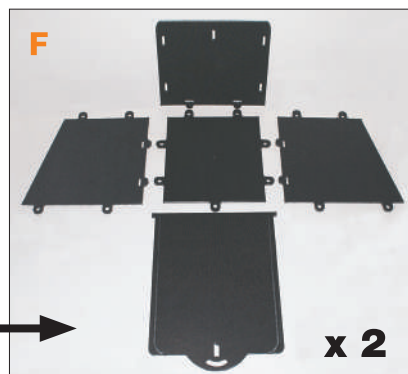
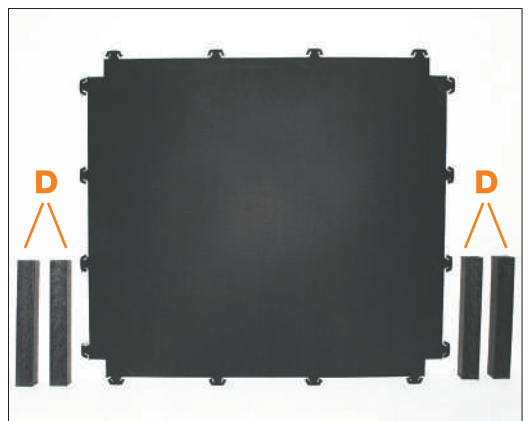
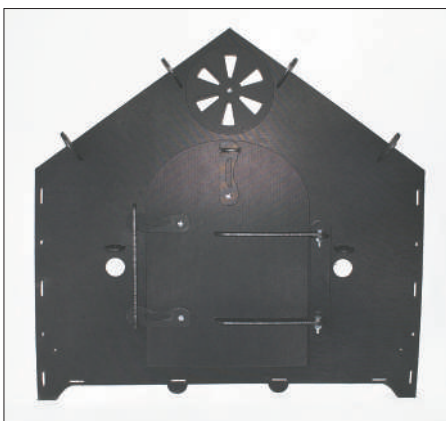
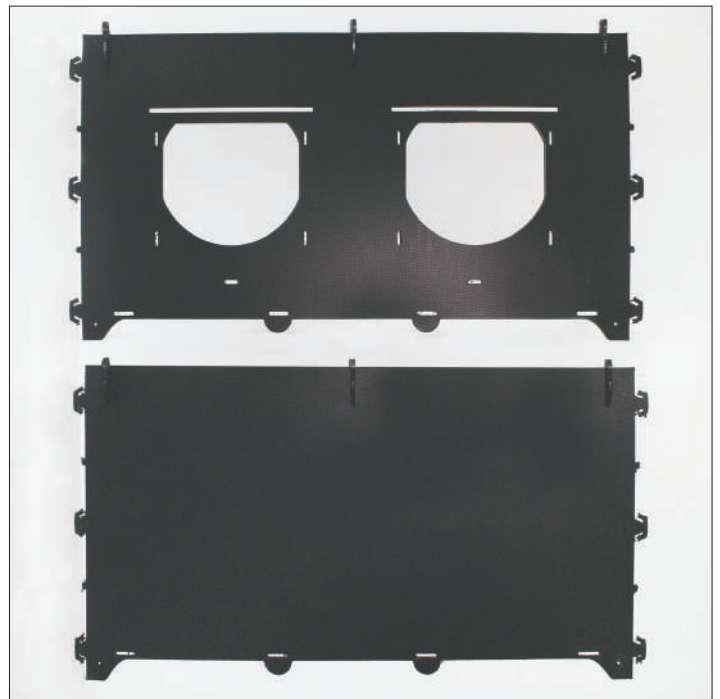
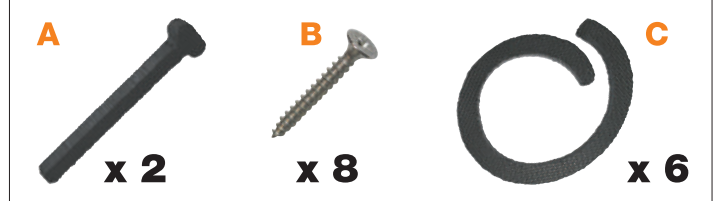

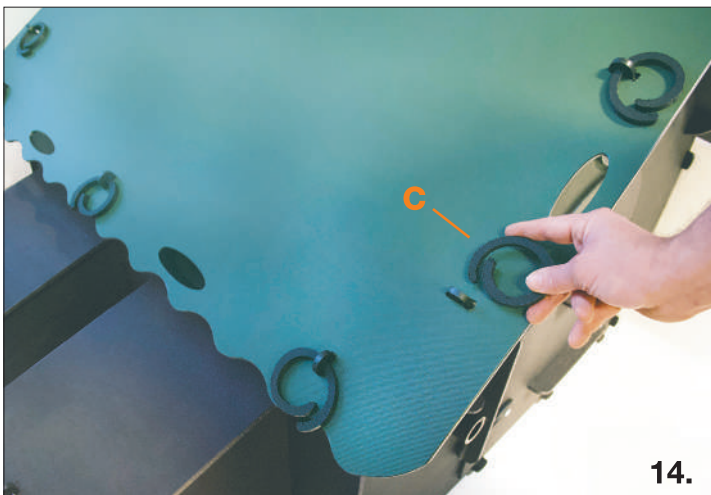
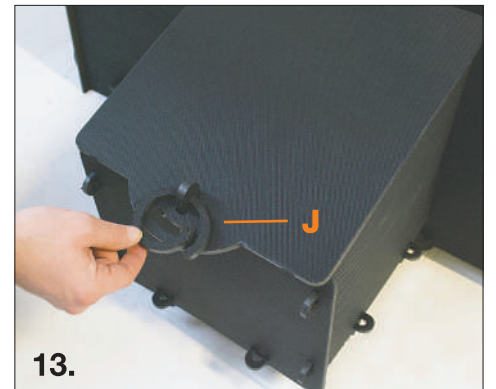
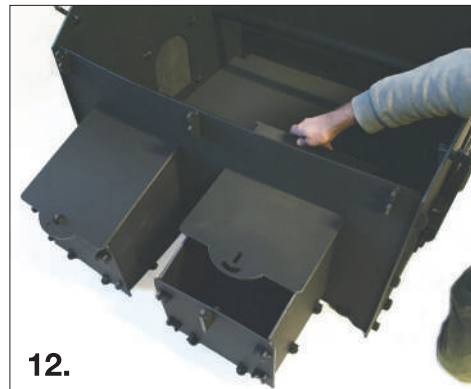
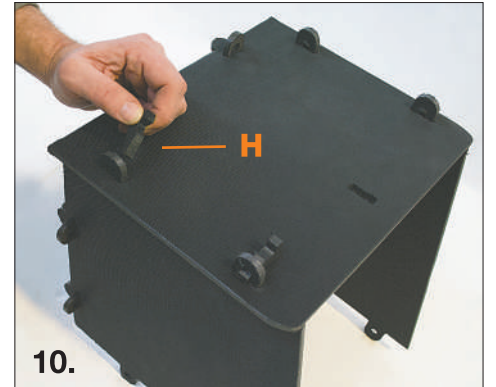
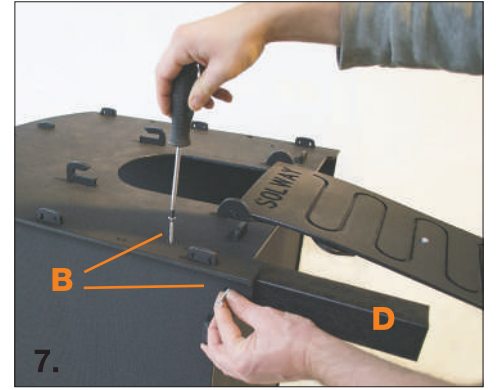
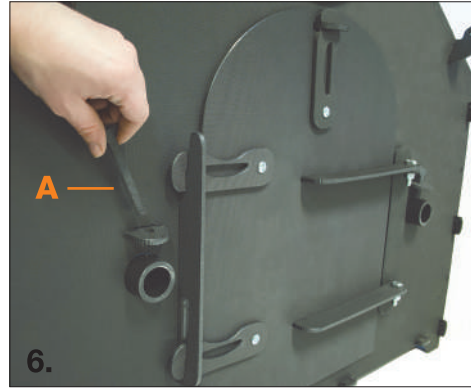
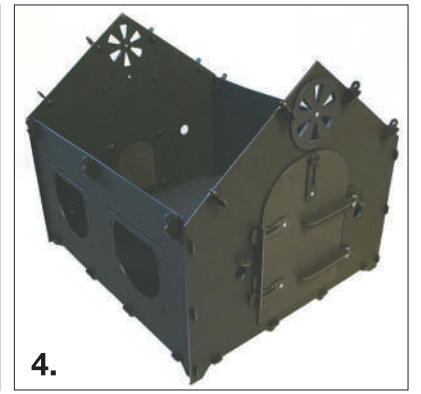
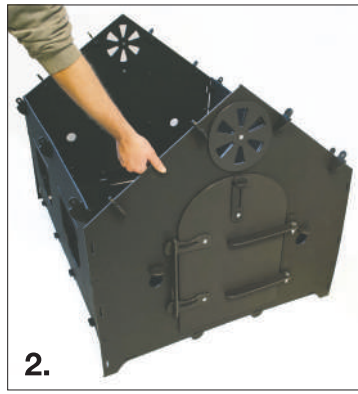
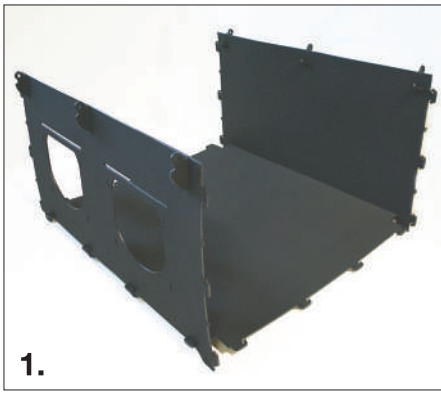

## Contact information

Head office:

Dancover A/S  
Lyngevej 16A, Nørre Herlev  
3400 Hillerød  
Denmark

For more information  
please visit:  
[www.dancovershop.com](http://www.dancovershop.com)

## National contact

Denmark:

[denmark@dancover.com](mailto:denmark@dancover.com)

UK:

[uk@dancover.com](mailto:uk@dancover.com)

Germany:

[germany@dancover.com](mailto:germany@dancover.com)

France:

[france@dancover.com](mailto:france@dancover.com)

Sweden:

[sverige@dancover.com](mailto:sverige@dancover.com)

Finland:

[suomi@dancover.com](mailto:suomi@dancover.com)

Poland:

[polska@dancover.com](mailto:polska@dancover.com)

Luxembourg:

[luxembourg@dancover.com](mailto:luxembourg@dancover.com)

Portugal:

[portugal@dancover.com](mailto:portugal@dancover.com)

Spain:

[espana@dancover.com](mailto:espana@dancover.com)

Italy:

[italia@dancover.com](mailto:italia@dancover.com)

Switzerland:

[schweiz@dancover.com](mailto:schweiz@dancover.com)

Austria:

[austria@dancover.com](mailto:austria@dancover.com)

Norway:

[norge@dancover.com](mailto:norge@dancover.com)

Nederland:

[nederland@dancover.com](mailto:nederland@dancover.com)

Ireland:

[ireland@dancover.com](mailto:ireland@dancover.com)

Belgium:

[belgique@dancover.com](mailto:belgique@dancover.com)