

DANCOVER[®]

.com

Manual
for
Storage Tent Arched
9,15x12x4,5m PVC

DANCOVER[®]

.com

Safety Advice

Attention

In some countries approval is needed to set up a marquee/tent larger than 75 m². It is your responsibility to comply with local rules and regulations and to ensure that the marquee/tent is assembled correctly.

In case of bad weather conditions, it is your responsibility to ensure the marquee/tent is safely secured and that the marquee/tent does not cause damage to others.

Do not use open fire, welding equipment or other sources which can ignite, inside or close to the tent.

The marquee/tent must be safely secured. We recommend you secure your marquee/tent with straps and pegs as soon as it is assembled.

Make sure to check if the marquee/tent is covered by your home contents insurance.

Marquees/tents must be evacuated under extreme weather conditions.

In the event of snow always remove snow from the roof of the marquee/tent regularly to prevent snow from building on the roof as heavy snow can cause the marquee/tent to collapse.

In the event of rain there is a risk of rain puddles building up on top of the roof of the marquee/tent. Heavy rain puddles can cause the roof to collapse. It is your responsibility to ensure rain puddles do not build up. As a precaution, make sure the roof of the marquee/tent is stretched out properly and adequately over the side frames of the marquee/tent and remove rain water regularly.

Do not unpack or repack your marquee/tent in freezing temperatures. In case of temperatures below zero always unpack and repack your marquee/tent indoors to avoid the risk of cracking parts.

The marquee/tent must be totally dry before you repack and store it to avoid mildew.

This structure is not tested for snow and wind loads. We always recommend that you remove snow from the roof. This is a none-permanent structure.

Maintenance: You must regularly check and retighten all assembly points of your storage shelter or garage tent. It is especially important to retighten the roof cover 1 month after having erected your shelter or tent. The roof cover of your shelter or tent must always be tensioned to withstand wind and weather.

Warranty Information

Please visit dancovershop.com for information on warranty.













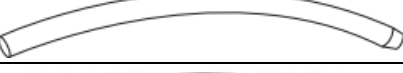
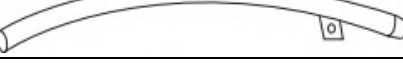





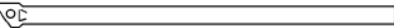
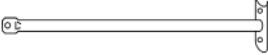

Please always check our website for the latest safety advice and manual.

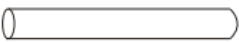
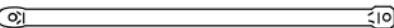
Assembly Illustration

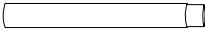



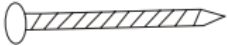







For “user friendly” assembly we have identified each individual component with our partcode number as indicated in the part list.

Please refer to the part code number and drawings to ensure problem free assembly.

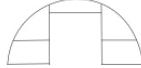
9.15x12x2x4.5m

Part number	Description	Qty.	Illustration	Box
1	Top roof curved tube	7		A
2	Roof curved tube	10		B
2A	Tube at front and rear	4		B
3	Sidewall tube	10		B
3A	Sidewall tube at front and rear	4		B
3B	Sidewall tube	14		B
4	Roof purlin and horizontal tube	30		A
5L	Base flange in corner in left corner	2		B
5R	Base flange in corner in right corner	2		B
6	Base flange for standing legs in front and back panel	4		A
7	Base flange for sidewall	10		A
8	Lower standing leg in front and rear panel	4		A
9	Upper standing leg in front and rear panel	4		A
10	Side beam for front and rear	4		A
11	Male beam for front and rear with 1 wheel pulley	2		A
11A	Female beam for front and rear with 2 wheels pulley	2		A
12	Bottom tensioning tube for front and rear cover	4		A
13	Standing support tube	4		A
13A	Tube slip for standing support tube	8		B
14	Male Tensioning tube for lower roof cover	12		A
14A	Female Tensioning tube for lower roof cover	2		A
15	Male Door dropping tube at the bottom	2		A
15A	Female Door dropping tube at the bottom	2		A
16	Stake peg	50		B
17	Bolt M10x110	35		B
18	Bolt M10x90	132		B

9.15x12x2x4.5m

Part number	Description	Qty.	Illustration	Box
18A	Bolt M10x100	16		B
19	Bolt M10x30	20		B
20	Bolt M10x75	4		B
21	Tie down ratchet	14		B
21A	Bolt M10x12 for Tie down rathcet	28		B
22	Roof cover	1		A
23	Front and back cover	2		A
24	Lace rope for roof cover, front cover and rear cover	1Roll		B
26	Plastic cap for tensioning tube	12		B
27	Plastic cap for part 15	4		B
29	Hexagonal Washer M10	237		B
30	Hexagonal Nut M10	209		B
31	Nylon tensioning band for tie down ratchet	14		B

Placement of base plates

UNIT:mm

Figure 2

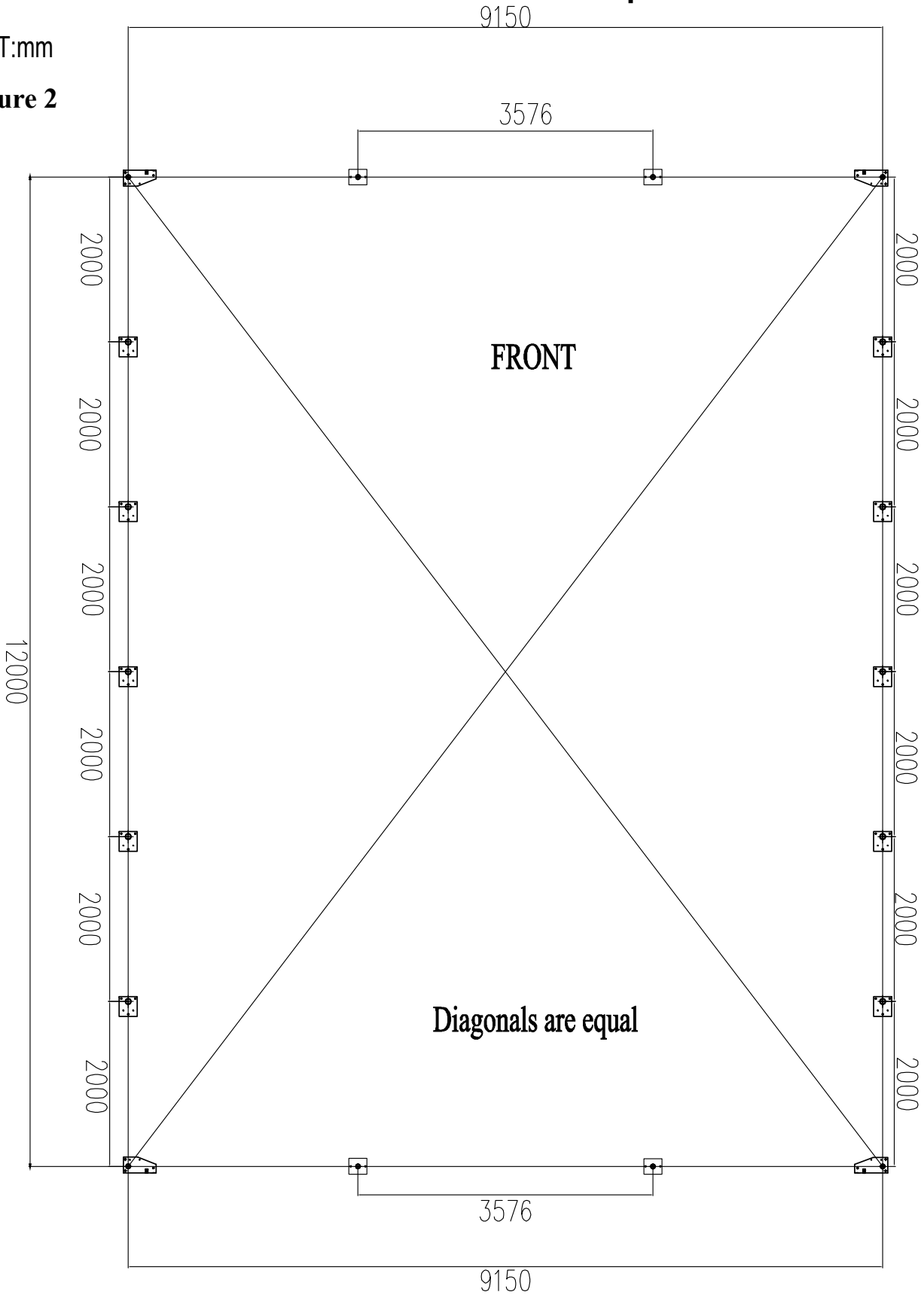

Fixing Base Flanges

As Figure 3 shows each Flange Base is equipped with 3 pieces of Stoke Pegs

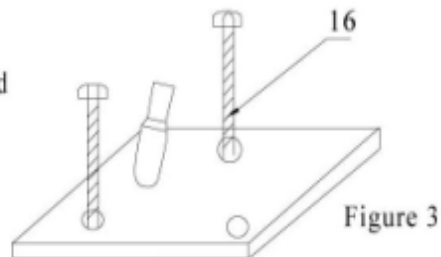
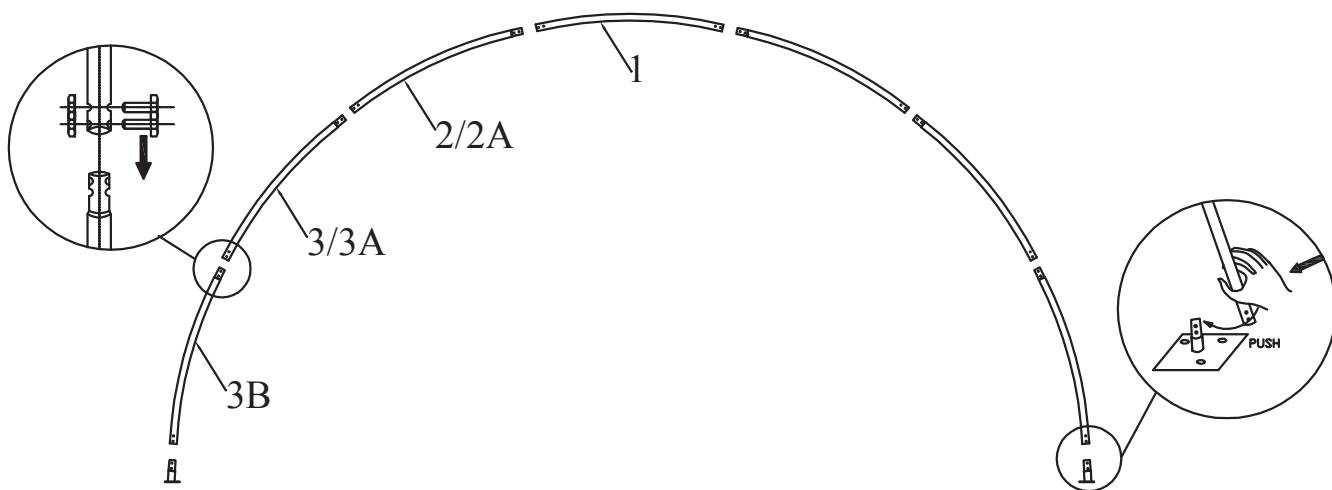
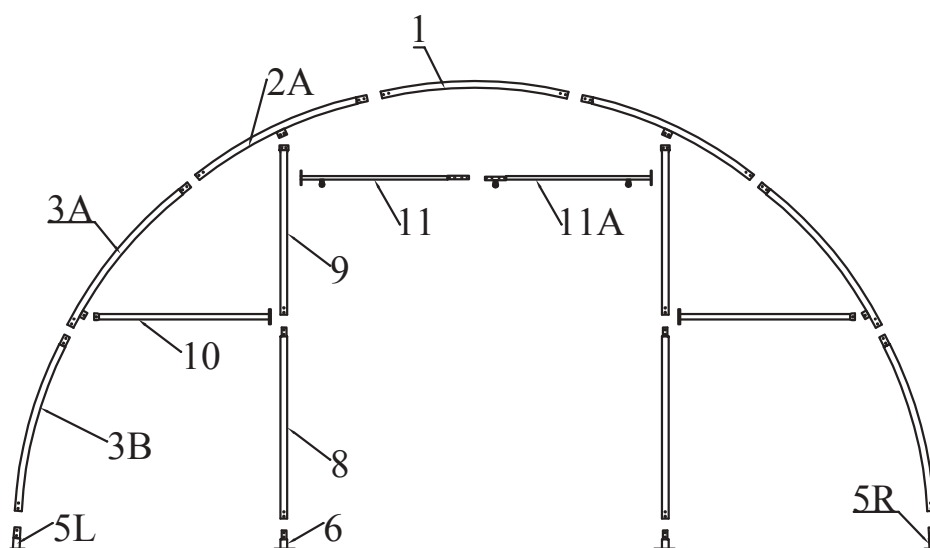

Figure 3

Frame installation for middle and back panel



Frame installation for front panel



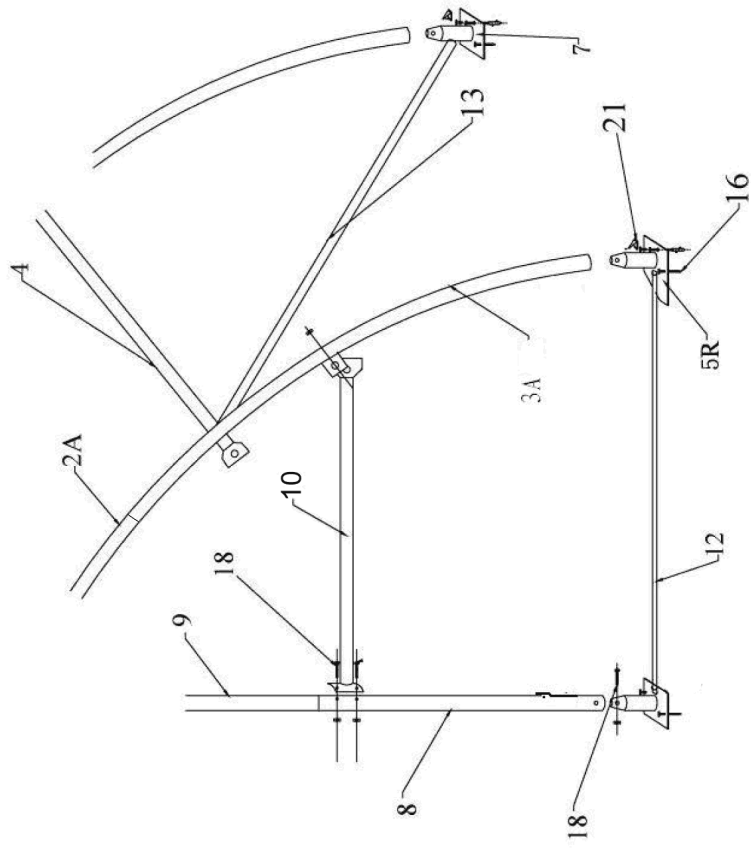

Figure 6 Installation of front panel

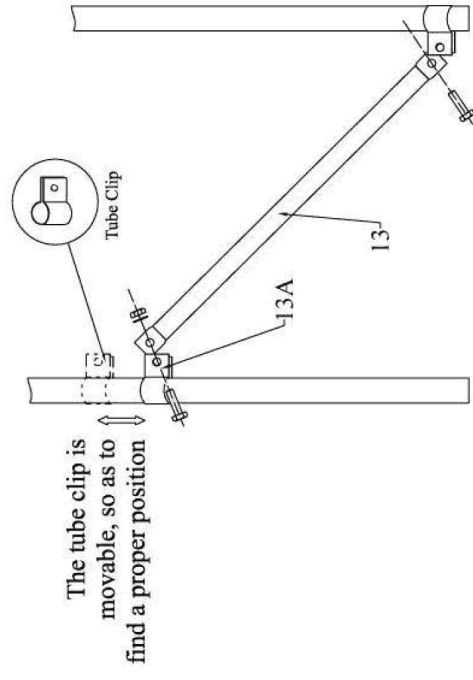
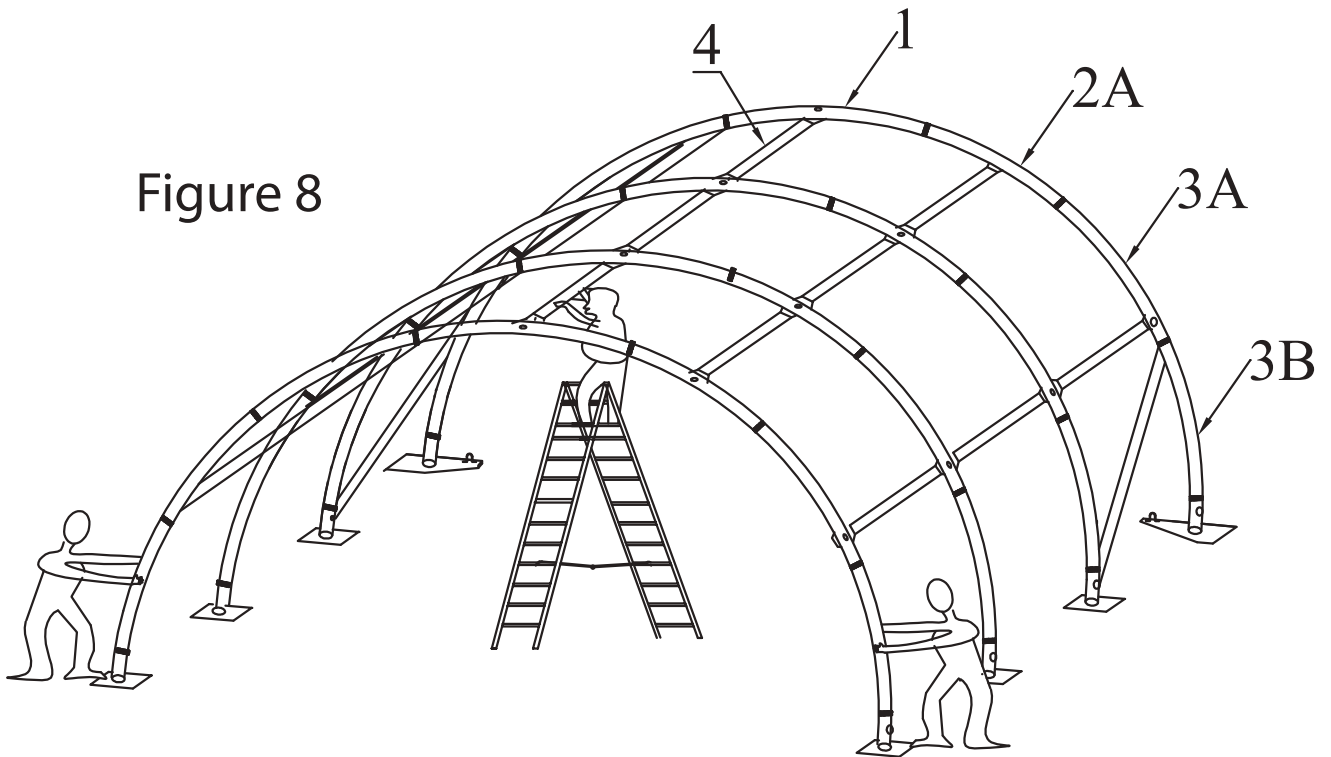

Figure 7: The way to fix the Slanting support tube to the frame.

Hint of Installation of Steel Frame

Figure 8



Method of Roof Cover Installation

As per Figure II, please pull the roof cover over the frame evenly.

Figure 9

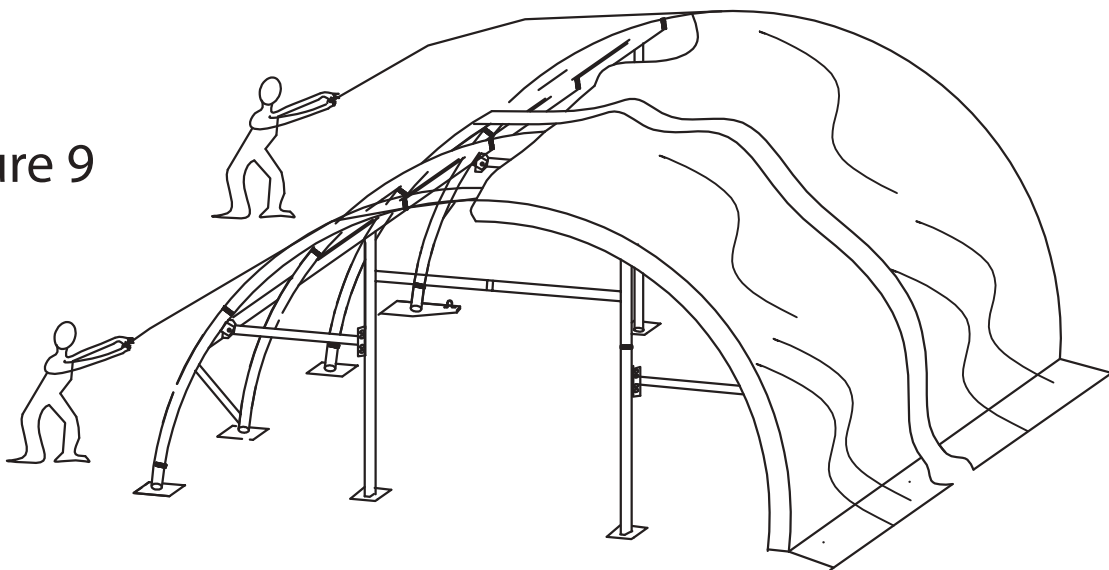

Method of Fastening Roof Cover

As per figure 10, please tighten the rope at the four corners of the roof cover. When the roof cover folds to the frame well, please tie end of the bands to the clips.

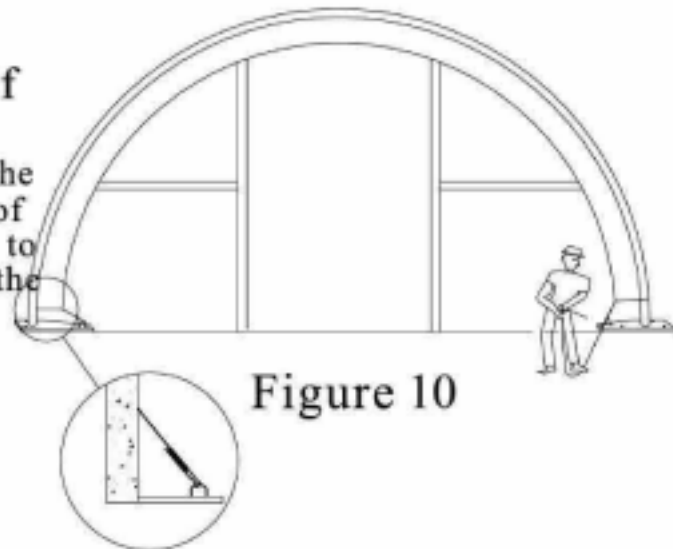

Figure 10

Please insert the Lower Roof Cover Tensioning Tube(part code 14) into the "sleeves" of the bottom of both sides of roof cover. In the meanwhile please put the Nylon Band(part code 31) onto the tubes and pull the Nylon Bands through the reels of the Ratchet Tie Down (part code 21). Please pull the Down Ratchet forth and back with the roof fastening finished.

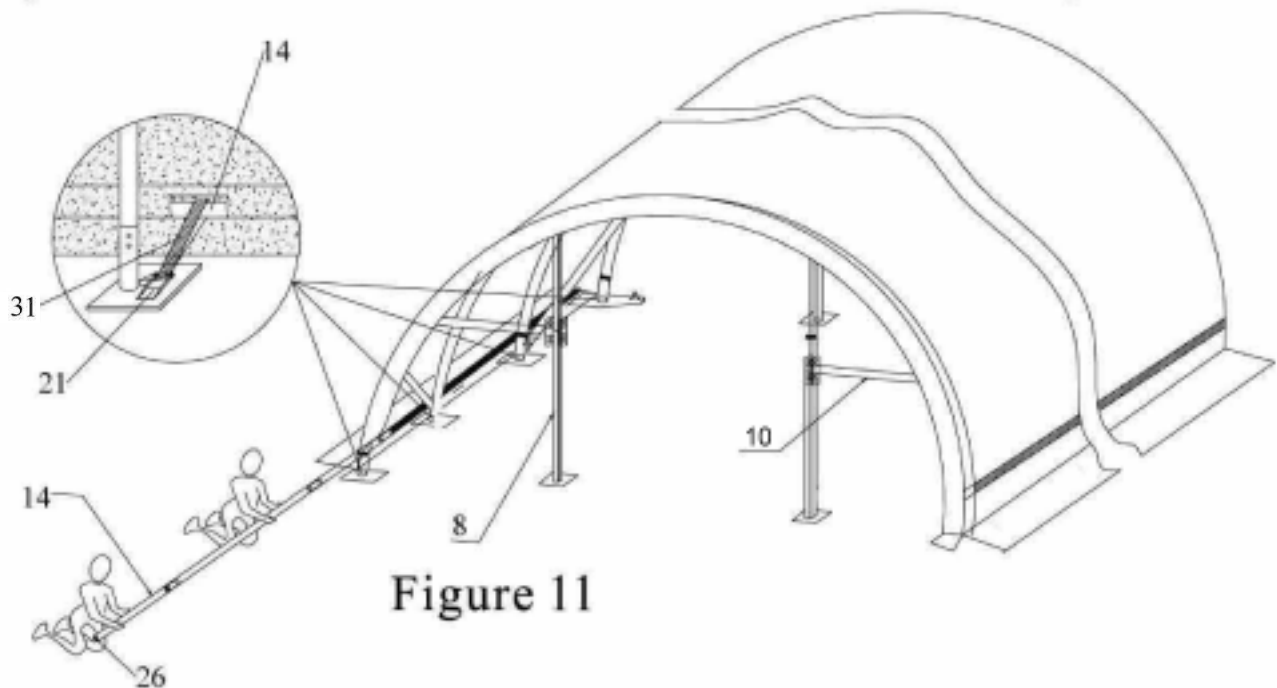
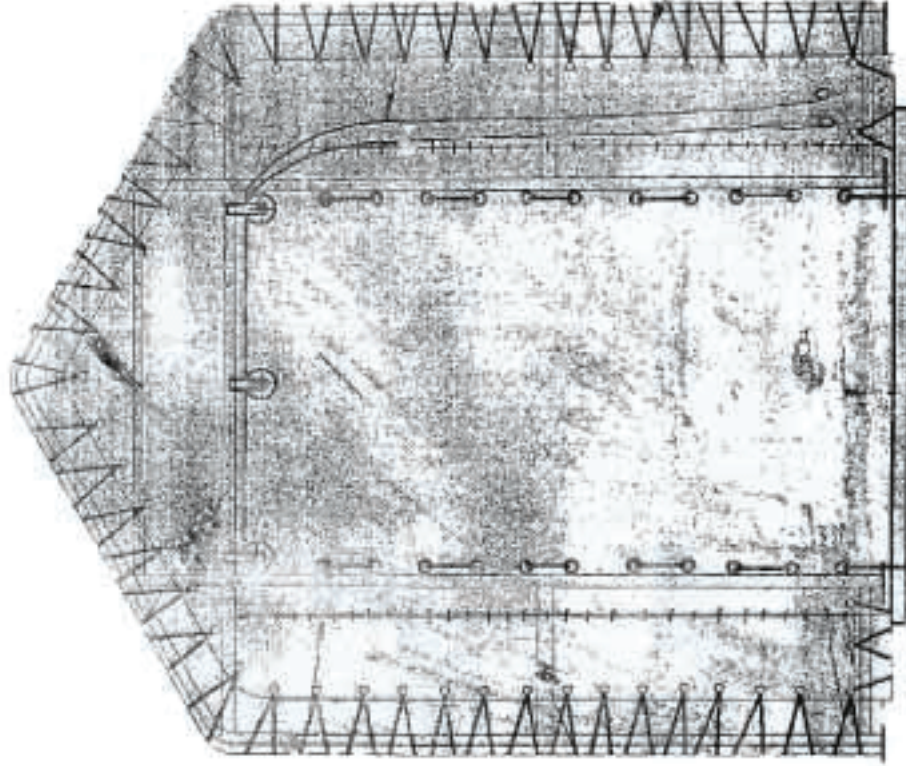

Figure 11

Door(view from inside)



1. Pls fix the edges of front cover
To the frames by ropes.
And insert the door dropping tube
into the bottom pocket of front cover
2. Pls put the rope in the left eyelets
Through the tackles on the cross tube
And drop down it on the right
3. When you want to open the door,
Firstly pls open the zipper by rope
With hook and go into the shelter.
Then pls pull the two ropes on right to raise the door.
When the door is raised to top,
pls bind the two ropes to standing legs.

**Figure 12 Installation of Front Cover
(Seeing from Inside)**

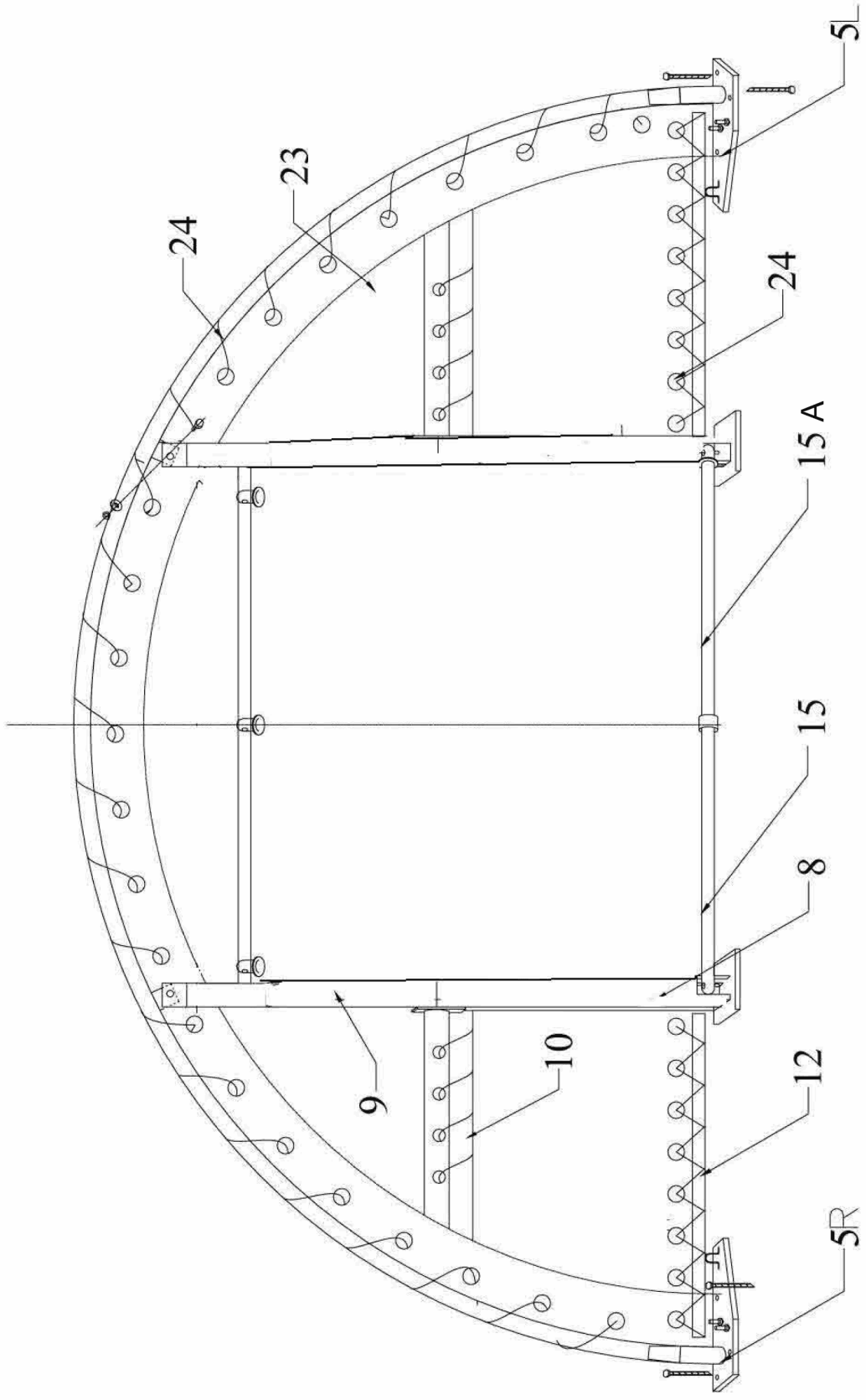

Remark Page:

Assembly Steps

1. Make certain the position of each Base Flanges by measurement and fix them to the ground.
2. Each group of sidewall is made up of Curved Roof Tubes, Sidewall Tubes (Vertical Tubes). Plz assemble every group of sidewall by bolts in turn on the ground, as per figure 'a' shows.
3. Put the left sidewall into the receiving tube on left Base Flange, and push the right sidewall to the receiving tube on right Base Flange. Because it needs tension for every group of sidewall, plz push hard the right sidewall to the receiving tube on right Base Flange, as per figure 'b' and 'c' show.
4. When finishing fixing the first and second groups of sidewall to the Base Flanges, plz install Horizontal Tubes by bolts, as per figure 'd' shows. Plz repeat the above steps to assemble and fix all groups of sidewall and Horizontal tubes.
5. After finishing installation of all sidewalls and horizontal tubes, plz assemble the tubes in front and rear(back) panels. When installing them, plz find the relative parts and assemble them according the figures.
6. After finishing installing frame, plz put the Roof Cover evenly over the frame. Put the Cover Tensioning Tubes through the pockets at the bottom of both sides of roof cover. Then pull the Tie Down Ratchets forth and back to tension the roof cover. Then plz fasten the end of roofcover by ropes and tie up the ropes to the flanges well.
7. Plz fix the front and rear(back) cover to the frame by the parts according to the figures shows.

This is a general step of assembly, plz kindly finish the other small steps such as the door installation by yourself.

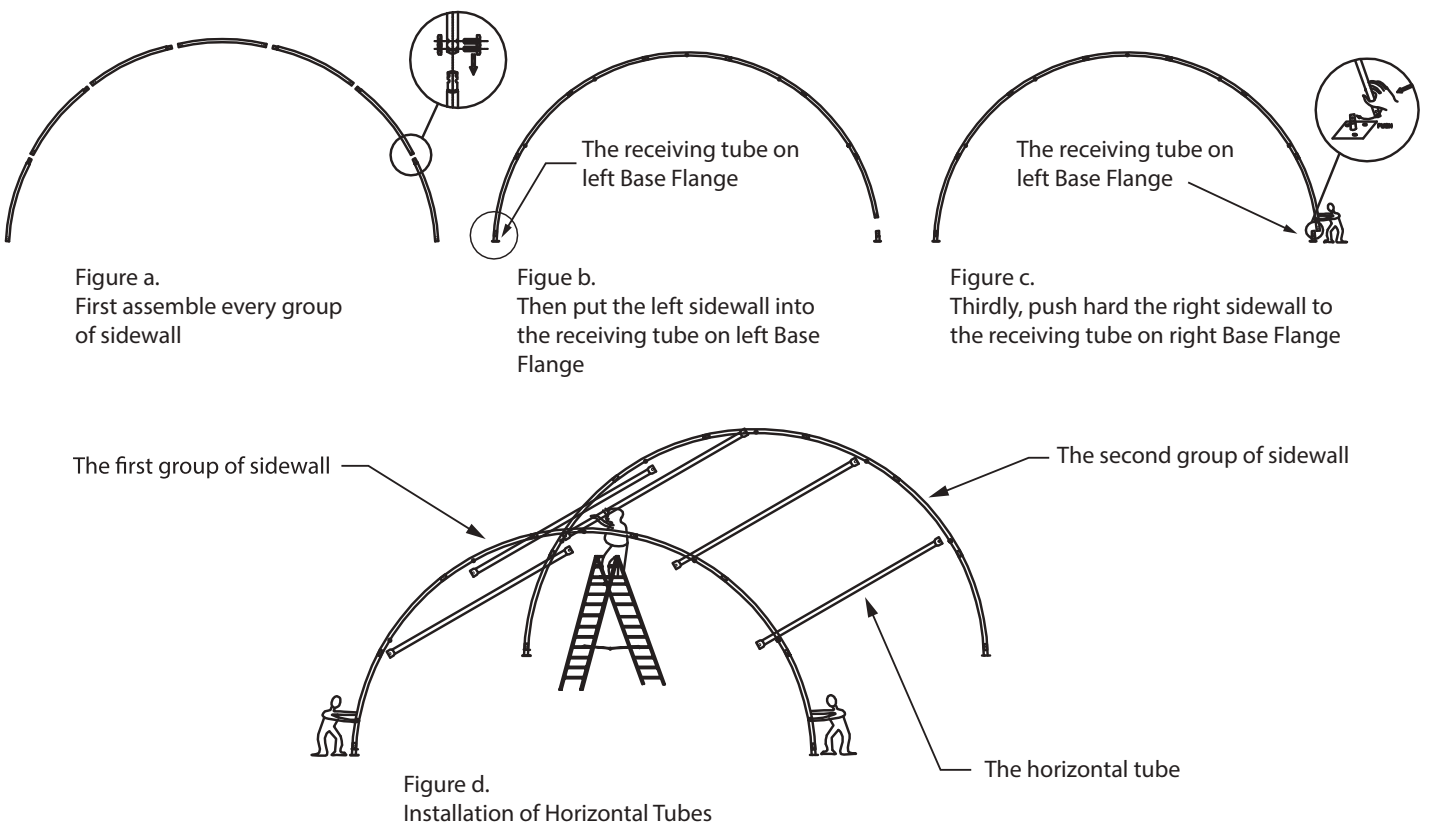

DANCOVER[®]

.com

Contact information

Head office:

Dancover A/S
Nordre Strandvej 119 G
3150 Hellebæk
Denmark

For more information
please visit:
www.dancovershop.com

National contact

Denmark: 70 26 76 20
denmark@dancover.com

UK: 020 8099 7570
uk@dancover.com

Germany: 041 0266 7040
germany@dancover.com

France: 0975 181 800
france@dancover.com

Sweden: 040 233 262
sverige@dancover.com

Finland: 0 931 581 720
suomi@dancover.com

Poland: 22 300 8602
polska@dancover.com

Luxembourg: +49 041 0266 7040
luxembourg@dancover.com

Portugal: 308 800 899
portugal@dancover.com

Spain: 911 436 828
espana@dancover.com

Italy: 02 479 21 198
italia@dancover.com

Switzerland: 0840 000125
schweiz@dancover.com

Austria: 0662 626935
austria@dancover.com

Norway: 231 00 690
norge@dancover.com

Nederland: 0 858 880 524
nederland@dancover.com

Ireland: 0 151 33 003
ireland@dancover.com

Belgium: 0 28 08 08 09
belgique@dancover.com