

DANCOVER[®] .com

Manual
Garage tent
2,7x5,1x2,3m

DANCOVER[®]

.com

Safety Advice

Attention

In some countries approval is needed to set up a marquee/tent larger than 75 m². It is your responsibility to comply with local rules and regulations and to ensure that the marquee/tent is assembled correctly.

In case of bad weather conditions, it is your responsibility to ensure the marquee/tent is safely secured and that the marquee/tent does not cause damage to others.

Do not use open fire, welding equipment or other sources which can ignite, inside or close to the tent.

The marquee/tent must be safely secured. We recommend you secure your marquee/tent with straps and pegs as soon as it is assembled.

Make sure to check if the marquee/tent is covered by your home contents insurance.

Marquees/tents must be evacuated under extreme weather conditions.

In the event of snow always remove snow from the roof of the marquee/tent regularly to prevent snow from building on the roof as heavy snow can cause the marquee/tent to collapse.

In the event of rain there is a risk of rain puddles building up on top of the roof of the marquee/tent. Heavy rain puddles can cause the roof to collapse. It is your responsibility to ensure rain puddles do not build up. As a precaution, make sure the roof of the marquee/tent is stretched out properly and adequately over the side frames of the marquee/tent and remove rain water regularly.

Do not unpack or repack your marquee/tent in freezing temperatures. In case of temperatures below zero always unpack and repack your marquee/tent indoors to avoid the risk of cracking parts.

The marquee/tent must be totally dry before you repack and store it to avoid mildew.

Maintenance: You must regularly check and retighten all assembly points of your storage shelter or garage tent. It is especially important to retighten the roof cover 1 month after having erected your shelter or tent. The roof cover of your shelter or tent must always be tensioned to withstand wind and weather.

Warranty Information

Please visit dancovershop.com for information on warranty.

Please always check our website for the latest safety advice and manual.

SPECIFICATION

Length:5.10M Width:2.70M Height:2.30M

SAVE THIS MANUAL

You will need this manual for the safety instructions, assembly instructions, operating procedures, parts list, and diagram. Write your invoice number on the inside front cover. Put both your manual and invoice in a safe, dry place for future reference.



IMPORTANT SAFETY PRECAUTION







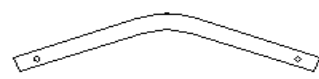
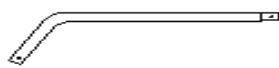
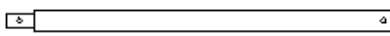
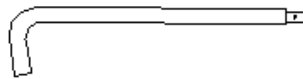
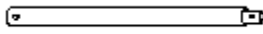
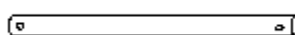
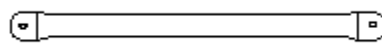
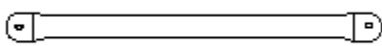
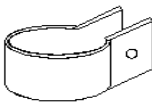
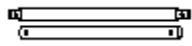
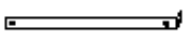

WARNING: When assembling the Garage, Base safety precautions should always be followed to reduce the risk of personal injury.

READ ALL INSTRUCTIONS BEFORE ASSEMBLY

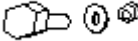
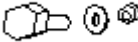
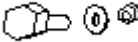
1. Keep work area clean. Cluttered areas invite injuries.
2. Be aware of your surroundings. Do not set up near snow drifts, in slippery places, in high winds, or wet location.
3. Keep children away. All children should be kept away from the work area.
4. Don't over reach. Keep proper footing and balance at all times.
5. Do not assemble if under the influence of alcohol or drugs. Read warning labels on prescriptions to determine if your judgment or reflexes are impaired while taking drugs. If there is any doubt, do not assemble.
6. Be aware of possible windy conditions. fasten the Bases in concrete if this condition is likely to occur. Remove the cover during windy condition.
7. Clean off snow before entering. Do not allow snow to sit for extended periods of time.
8. Be aware of the height of the garage. Put antennas down When entering Garage. Make sure your vehicle will fit in Garage before entering.
9. Only for use as a vehicular garage. Do not allow animals to enter. Not for use as a temporary or permanent habitation. Do not alter the Garage in any way.
10. Be careful of the frame .do not hang anything other than(included parts) from the frame of the Garage. Do not hang from or pull on the tubes. Do not climb on the frame.
11. Be careful with power and heat sources . Do not keep heat sources near the tarpaulin. Do not expose to open flame.
12. Be aware of personal safety during assembly and use. Be careful not to pinch fingers with clips and tubes when assembling: when using made sure There is adequate ventilation for exhaust and other dangerous fumes.

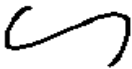
Packing List of Model B788 (2.7*5.1*2.3M)

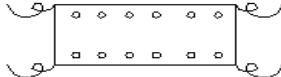
Part Code	Description		Quantity Box
1	Top roof curved tube		5
2	Roof curved tube		10
3	Sidewall tube		6
3A	Sidewall tube at front and rear		4
4	Roof purlin an horizontal tube		9
4A	Roof purlin and horizontal tube		3
5	Cross bar		5
6	Standing support tube		2
6A	Tube slip for standing support tube		14
7	Tension at the bottom of the tube		2sets
7A	At the bottom end tighten tube		4
8	Stake peg		20

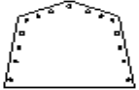
8A	Tube clip		10
9	M6 * 65 ball stud		25
10	M6*40 hex bolt		12
11	M6*25 hex bolt		16
12	M6*40 hex bolt		4
13	Plastic cap for tensioning tube		16
14	Lace rope for roof cover front cover rear cover		40m
15	S hook		8
16	The S hook rope of the door		4
17	Roof cover		1
18	Door cover		1
19	Back cover		1

27-05-2014-QJ

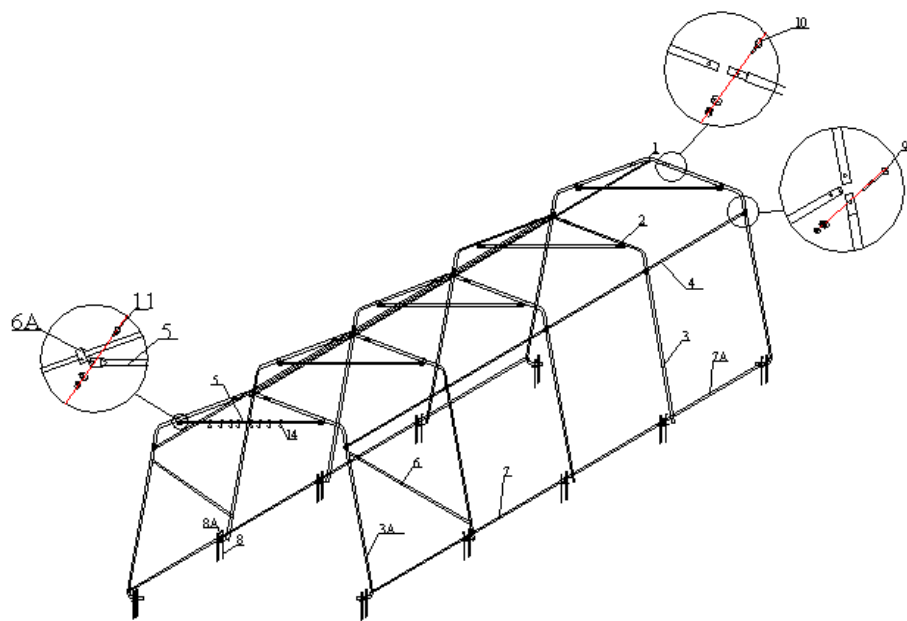

Figure 1
Sketch of Model B788 Size: W2.7*L5.1*H2.3M

Step #2 -- ARCH ASSEMBLY

Assemble each arch on ground. Each arches consist of:

One curving roof tube (Part #1)

Two roof curving tube (Part #2)

Two curving sidewall tube (Part # 3/3A)

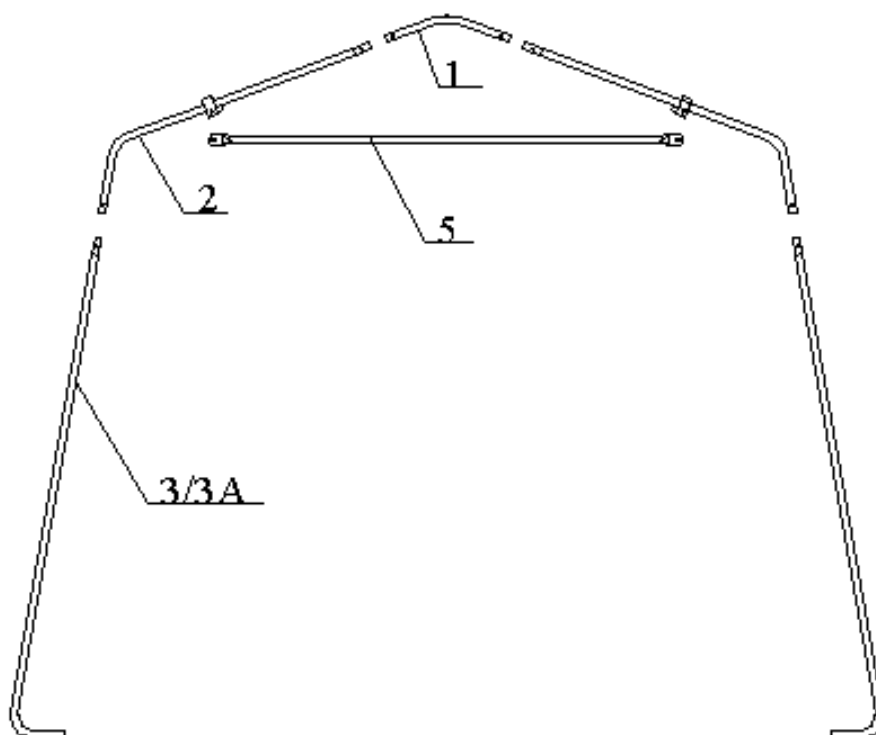

Figure 3 the arch installation

Connect the arches by Using the hexagon bolts with washers and nuts through predrilled holes in frame members. Do not tighten down the nuts completely until frame is fully assembled and set in place.

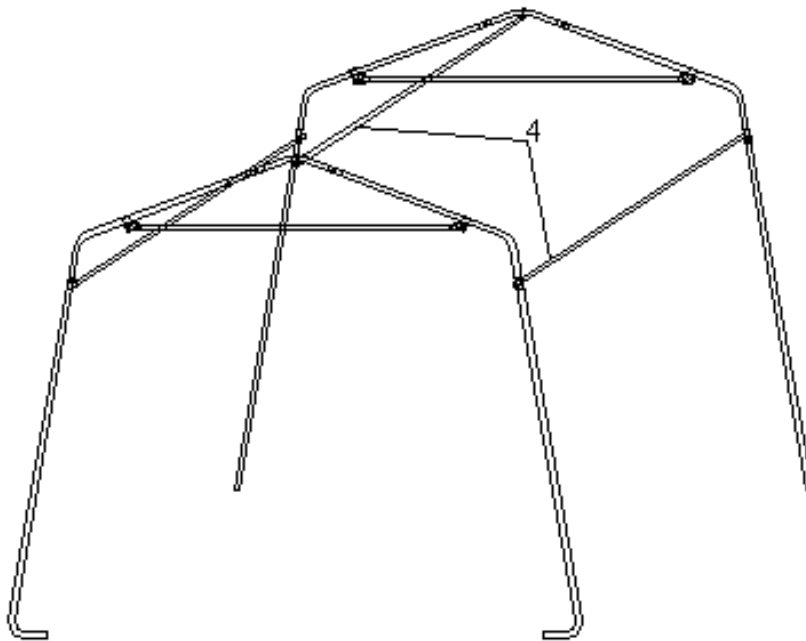

Figure 4

Immediately after putting first interior arch into place, connect Front Arch and Interior arch using Roof Purlin Tubes at top ridge and side shoulder curves of arches. Secure the Roof Purlin tubes into place using carriage bolts and nuts. Next install the Wind Brace supports(part#6) and Tube Clip(part#6A) that connect the Front Arch to the first Interior Arch. The Wind Braces give the arch assemblies strength as a unit. Use Bolt M10 X 30 at the end of each Wind Brace Support to secure. Continue to install other Arches Assemblies in the same manner. Overlap pinched ends of Roof Purlin onto same carriage bolts inside frame assembly. Next check entire frame assembly for square and plumb. Next tighten frame bolts adequately. **DO NOT** over tighten bolts so as to oval or compress frame components. .

Step #4 --POSITION ROOF COVER

As figure 8 shows, when ready to install Roof Cover, unpack cover and lay parallel to building frame on one side. Cover must be pulled over top of frame assembly without being snagged or stressed on any frame members. Use multiple ropes over top of frame as shown in picture below. Having another person inside frame on a ladder to assist in getting Roof Cover over frame will insure the cover will go on without any damage.

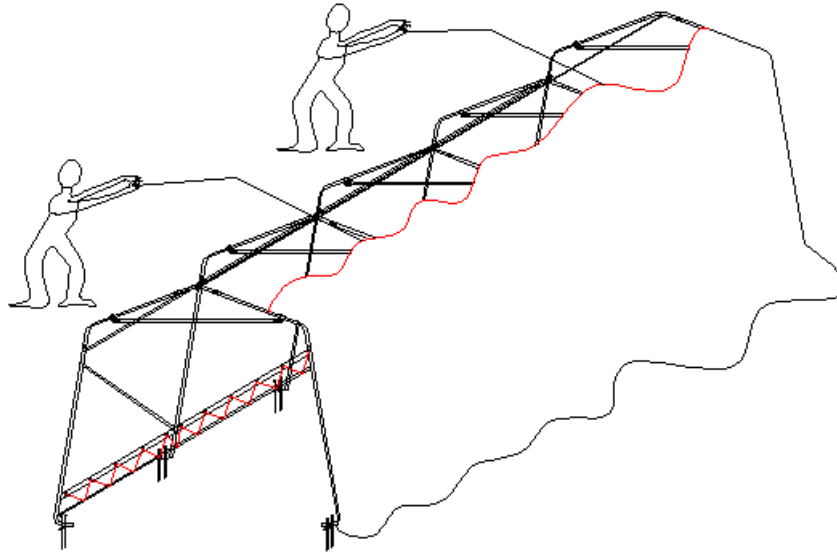

Figure 5:
Pull the Roof Cover over the frame evenly

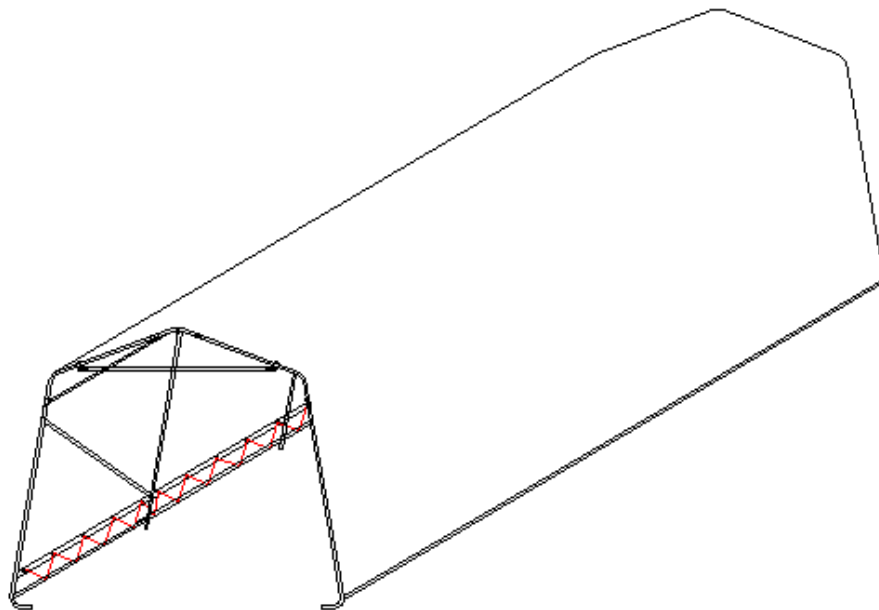

Figure 6 Fastening the Roof Cover

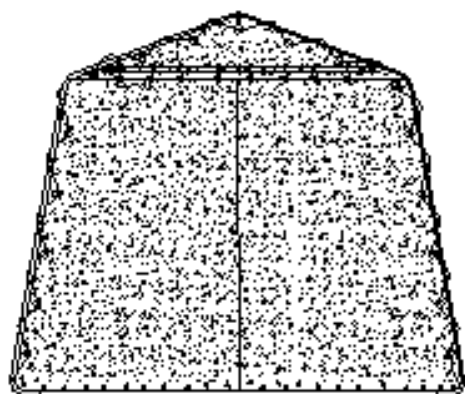

Figure 7
Installation of the Front Cover

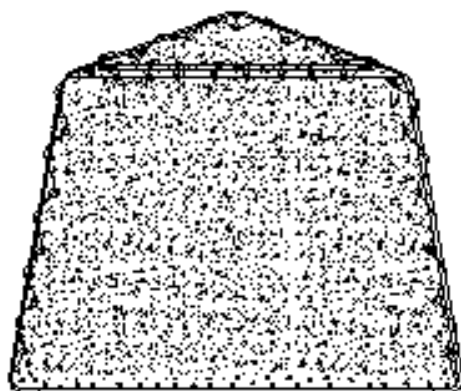

Figure 8
Fastening the two ends of the Roof Cover

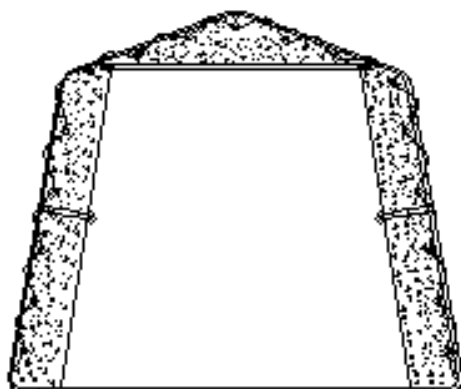

Figure 9 Open Door Cover

Contact information

Head office:

Dancover A/S
Nordre Strandvej 119 G
3150 Hellebæk
Denmark

For more information
please visit:
www.dancovershop.com

National contact

Denmark:

denmark@dancover.com

UK:

uk@dancover.com

Germany:

germany@dancover.com

France:

france@dancover.com

Sweden:

sverige@dancover.com

Finland:

suomi@dancover.com

Poland:

polska@dancover.com

Luxembourg:

luxembourg@dancover.com

Spain:

espana@dancover.com

Italy:

italia@dancover.com

Switzerland:

schweiz@dancover.com

Austria:

austria@dancover.com

Norway:

norge@dancover.com

Nederland:

nederland@dancover.com

Ireland:

ireland@dancover.com

Belgium:

belgique@dancover.com