

DANCOVER

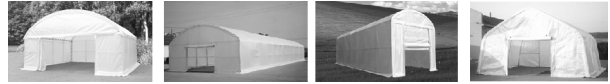

PORTABLE VEHICLE GARAGE

Installation manual

MODEL#Basic-162







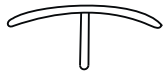
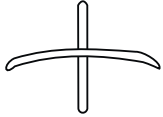
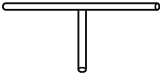
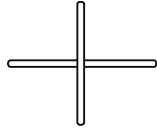

L2.59xW1.6xH1.93m

www.**DANCOVER**.com

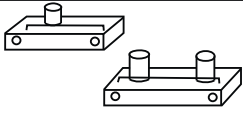
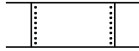
Phone+45 70 26 76 20

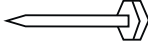
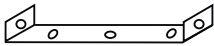

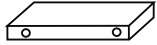
PART LIST

NO.	DESCRIPTION	Q'TY	ILLUSTRATION
1	ROOF TUBE	6pcs	
2	BENT 3-WAY-IN-1-FITTINGS	2pcs	
3	BENT 4-WAY-IN-1-FITTINGS	1pc	
4	STRAIGHT 3-WAYIN-1-FITTINGS	4pcs	
5	STRAIGHT 4-WAY-IN-1-FITTINGS	2pcs	
6	HORIZONTAL RODS	6pcs	
7	VERTICAL TUBES	6pcs	
11L 11R	BASE	4pcs	
13	ROOF COVER	1pc	
14	FRONT COVER	1pc	
15	BACK COVER	1pc	
16	ROPE	some	
17	STAKE PEGS	14pcs	
18 18A	BASE CONNECTING BRACKETS	3pcs	
19	FASTENING ROPE HANGING RING	4pcs	
20	CONNECTING SQUARE TUBES	2pcs	
21	BASE RUBBER COVER	4pcs	
22	CONNECTING SCREW	8pcs	

Basic-162 Frame Illustration

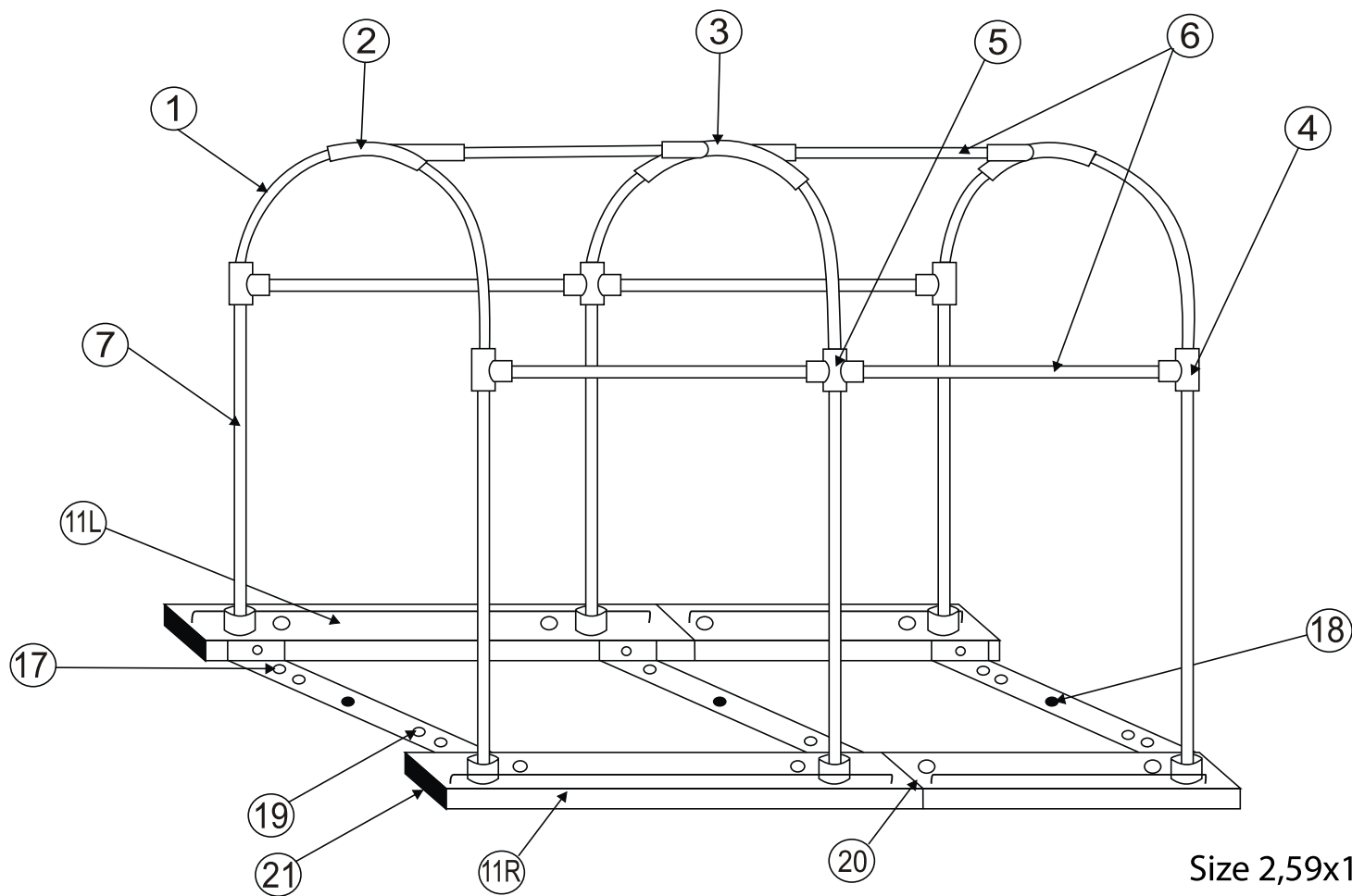

Size 2,59x1,6x1,93m
(lengthx widthxHeight)

Assembly Procedure

Base Assembly

Step 1: Using one Connecting Square Tube (#20) attach the Right Base (#11R), then using the other Connecting Square Tube (#20) attach the Left Base (#11L) See Figure 1.

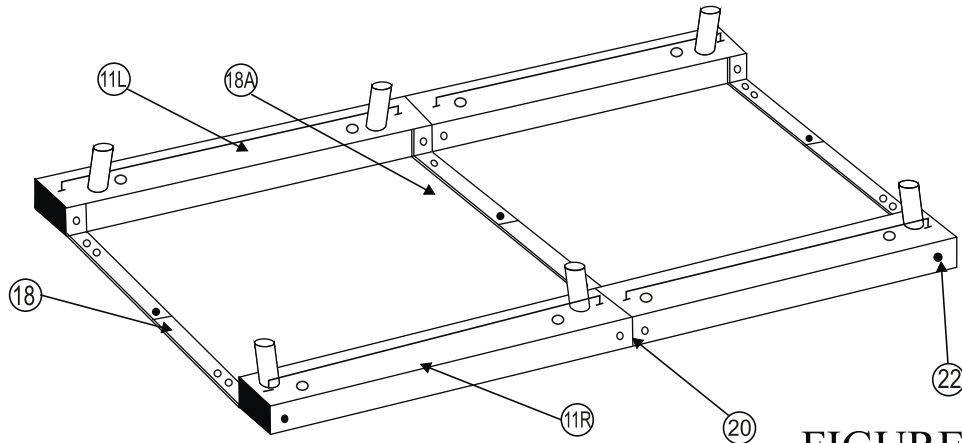

FIGURE 1

Step 2: Using the two Base Connecting Brackets (#18) attach Right Base (#11R) and Left Base (#11L) See Figure 1.

Step 3: Using the two Base Connecting Brackets (#18A) attach Right Base (#11R) and Left Base (#11L) See Figure 1.

Step 1: Using the Fastening Rope Hanging Rings (#19) to the hole of Base Connecting Brackets (#18) as shown in Figure 2

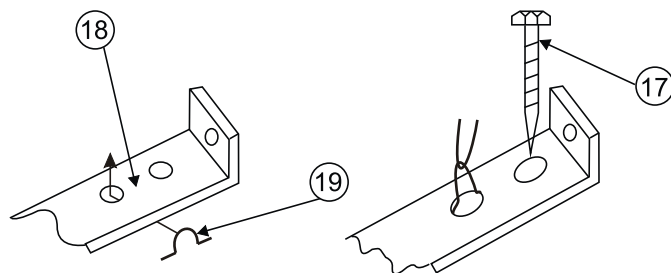

FIGURE 2

Step 2: using a Stake Peg (#17) to pull through the other hole of Base Connecting Bracket (#18 , 18A)

Tube Assembly

Step 1: Using the four Roof Tubes (#1) connect the two Bent 3-Way-In-1 Fittings (#2) and the four Straight 3-Way-In-1 Fittings (#4) to each other. Insert the Vertical Tubes (#7) into the four Straight 3-Way-In-1 Fittings (#4) as shown in Figure 3.

Then See Figure 3.

Insert the Vertical Tubes (#7) into the receivers of the Base.

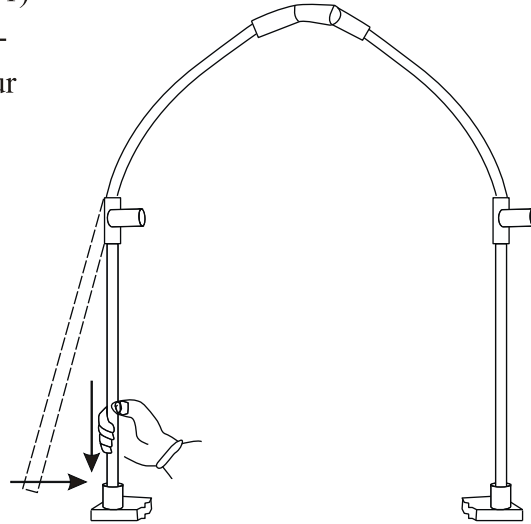

FIGURE 3

The same to the remaining group of ribs.

Step 2: Using the two Horizontal Rods (#6) connect the Bent 3-Way-In-1 Fittings (#2) and the Bent 4-Way-In-1 Fittings (#3). Then using the remaining two Horizontal Rods (#6) connect the straight 3-Way-In-1 Fittings (#4) and the Straight 4-Way-In-1 Fittings (#5).

Tarpaulin Assembly

Step 1: See Figure 4-1 and Figure 4-2. Pull the ROOF COVER (#13) over the frame. Attach the Front and Rear Rope of the TARPAULIN to the FASTENING ROPE HANGING RINGS (#19) at each corner.

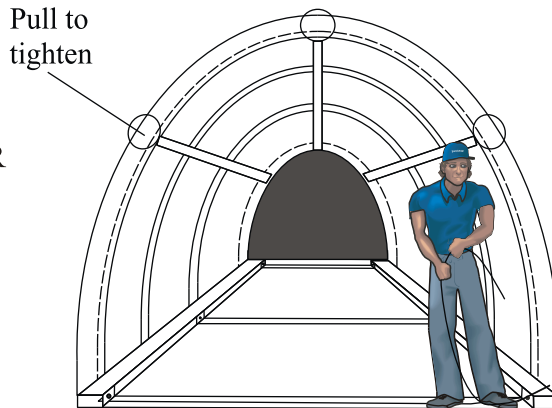

FIGURE 4-1

Step 2: Position the ROOF COVER so that 10cm hangs over in the front and rear. Pull tight at the positions marked "○" attach the frame parentetical as shown in Figure 4-1. Do tight the Rope. See Figure 4-2.

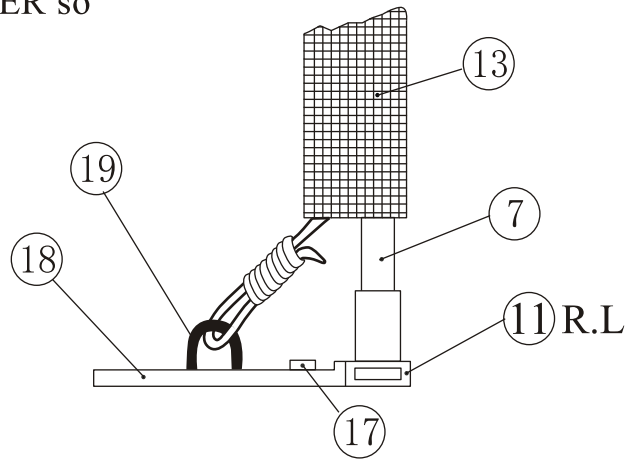

FIGURE 4-2

Step 3:A. Use the Rope (#16) attach the ROOF COVER (#13) to the Base (#11R/L) so that the ROOF COVER pulls tight.

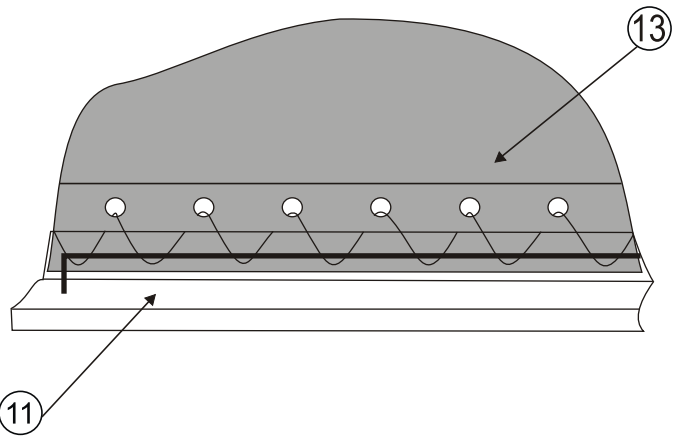
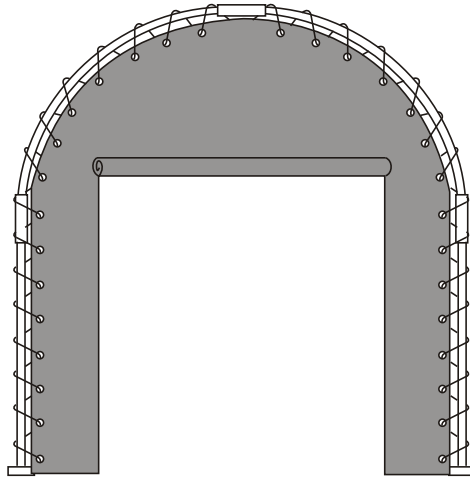

FIGURE 4-3

B. Using the Rope (#16) attach the sides of Front cover and Back cover to the frame.

Hint of installation of Front cover



Hint of installation of Back cover

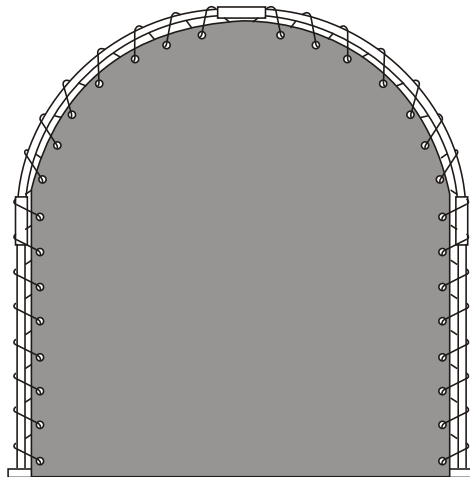

Out appearance with cover on

