

DANCOVER[®]

.com

Manual
Garage tent
5.4m serie

DANCOVER[®]

.com

Safety Advice

Attention

In some countries approval is needed to set up a marquee/tent larger than 75 m². It is your responsibility to comply with local rules and regulations and to ensure that the marquee/tent is assembled correctly.

In case of bad weather conditions, it is your responsibility to ensure the marquee/tent is safely secured and that the marquee/tent does not cause damage to others.

Do not use open fire, welding equipment or other sources which can ignite, inside or close to the tent.

The marquee/tent must be safely secured. We recommend you secure your marquee/tent with straps and pegs as soon as it is assembled.

Make sure to check if the marquee/tent is covered by your home contents insurance.











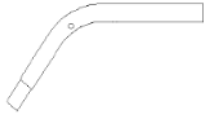

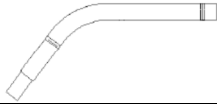

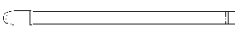
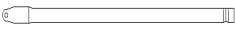





Marquees/tents must be evacuated under extreme weather conditions.

In the event of snow always remove snow from the roof of the marquee/tent regularly to prevent snow from building on the roof as heavy snow can cause the marquee/tent to collapse.

In the event of rain there is a risk of rain puddles building up on top of the roof of the marquee/tent. Heavy rain puddles can cause the roof to collapse. It is your responsibility to ensure rain puddles do not build up. As a precaution, make sure the roof of the marquee/tent is stretched out properly and adequately over the side frames of the marquee/tent and remove rain water regularly.

Please always check our website for the latest safety advice and manual.

PARTLIST FOR 5.4m series

Part no.	Description		6m	7,5m	9m	10,5m
1	Corner Arch		10	12	14	16
2	Female brace 60"		7	7	7	7
3	Leg		10	12	14	16
4	Center Arch		5	6	7	8
5	Male Door Rail		5	6	7	8
6	Female Door Rail		5	6	7	8
7	T-Bar		5	6	7	8
8	Male brace 63"		21	28	35	42
9	Diagonal 80"		4	4	4	6
10	Pipes holder		10	12	14	16
11	S Hook		32	32	32	32
12	Big Door Rail Hook		28	28	28	28
13	Elastic Bungee		32	32	32	32
14	Floor Bracket		8	8	8	8
15	Nail		16	16	16	16
16	Carriage Bolts 1 3/4"		6	7	8	9
17	Carriage Bolts 2 1/2"		11	13	15	17
18	Carriage Bolts 4"		27	33	38	43
19	Wing nuts		55	66	77	88
20	Big Plastic Caps for legs		10	12	14	16
21	Small Plastic Caps for cross pipe		14	14	14	14
22	Roof		1	1	1	1

DEAR CUSTOMER

Please use gloves when assembling the metal frame portion of this unit. The metal components of this product have been treated with a rust preventive coating that may feel oily to the touch. This coating is not dangerous, but may dirty your hands during assembly. We recommend that you wipe metal parts clean with a mixture of warm water and dish detergent prior to assembly. Should your hands become dirty, simply wash with soap and water.

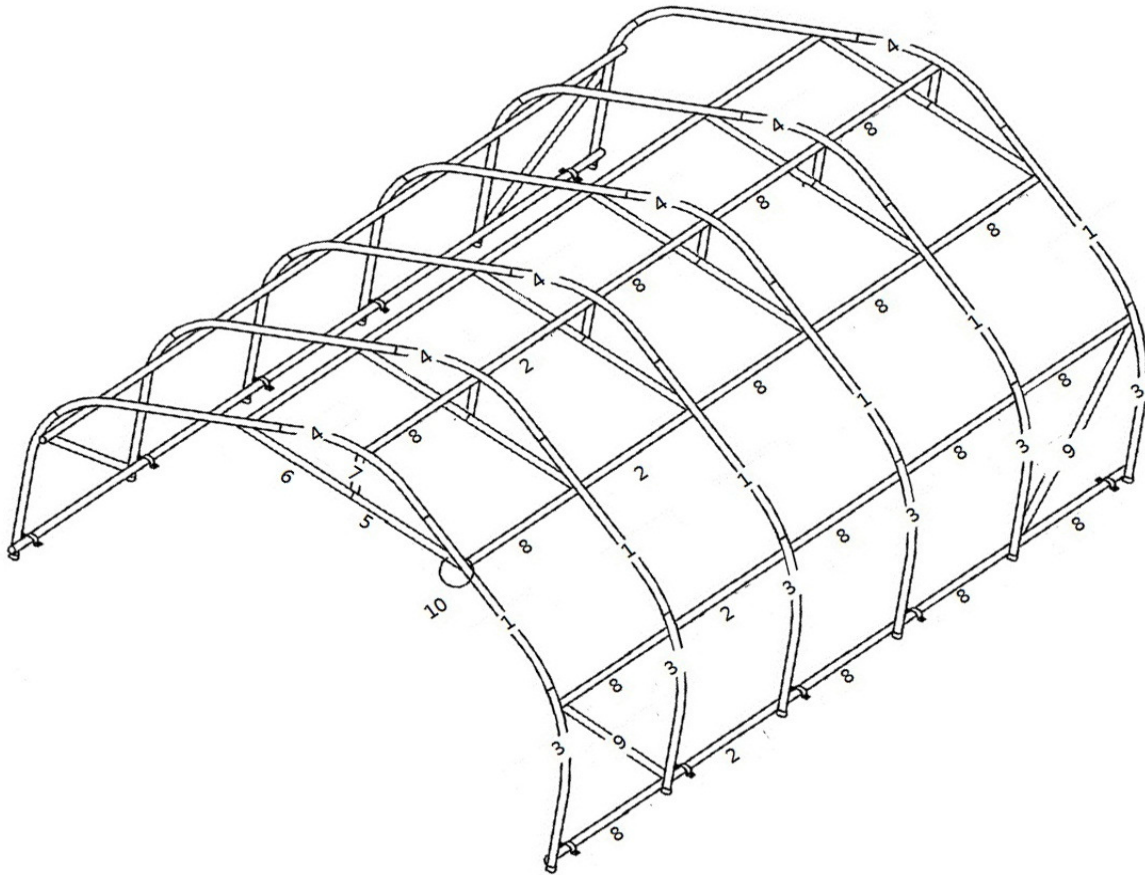

ASSEMBLY INSTRUCTIONS

1. Take a Center Arch (no.4) and on each end of it, assemble a Corner Arch (no.1). Secure the Male and Female Door (no.5) and (no.6) to the arch (no.1) with the pipes holder (no.10).
2. Slide the Rail Hooks over the Door Rails before tightening. Add the T-Bar (no.7) to the Door Rails and the center arch.

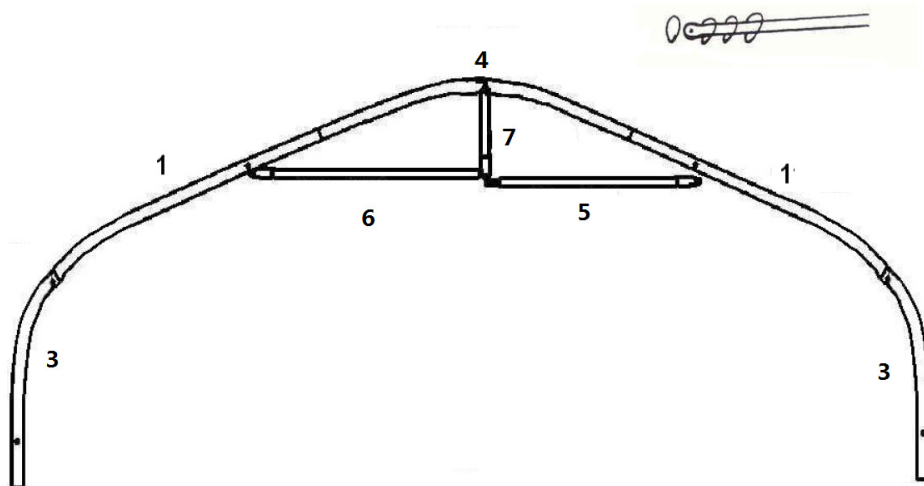

3. On each end of (no.1), install the Leg (no.3). Repeat step 1 for all frames.
4. At this point stand up the front or back frame and add 7 male connecting pipes (no.8). Then stand up another frame and add 7 female connecting pipes (no.2). For the remaining frames use the male connecting pipes (no.8).
5. Add the diagonals (no.9) to the first and last legs (no.3).
Note : Make sure all screws are tight. Do not over-tighten.

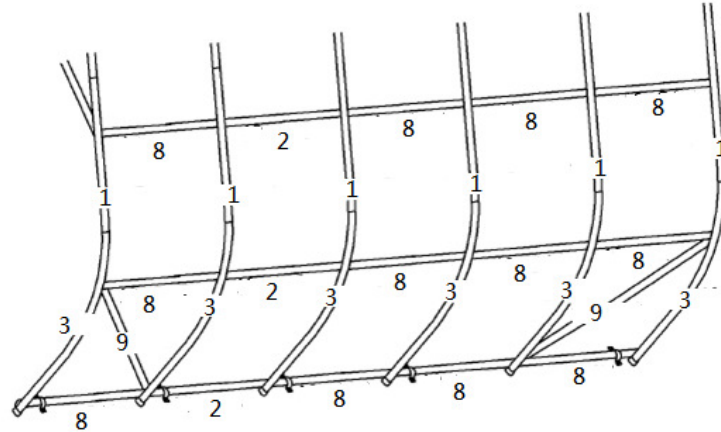

6. ROOF ASSEMBLY

Take the roof and place it over the structure. Make sure that the windows are on the two sides of the shelter, at front or at back as your choice. Make sure ties are inside.

Tie all the ties around the pipes. Take the straps and pass them underneath the pipes, pull up and tighten through metal buckle.

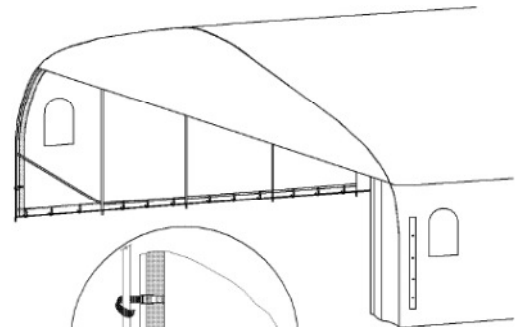

7. SHELTER REINFORCEMENT

Before you install the floor brackets, make sure the distance between the legs is 18 feet wide.

Place the floor brackets (14) at each end of the shelter. Then drive in nails (15) into ground, gravel or asphalt. Other material surfaces require other types of anchoring (cement blocks, sand bags, screws and bolts, etc). Permanent anchors are not provided with this unit.

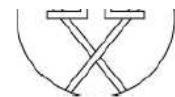
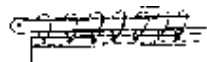
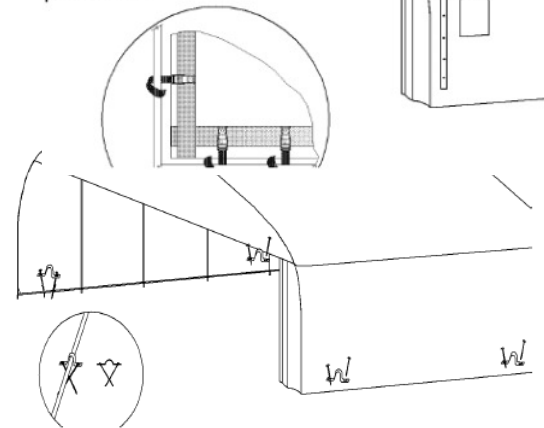

8. DOOR INSTALLATION

Install doors at each end. Use elastics (13) to attach the door to the roof with hooks (11). Close the end of hook on to the elastic so it won't fall on out. Use the rail hooks to attach door the door rails. When closing at the front, make sure all elastics are attached on the inside and outside of the shelters.

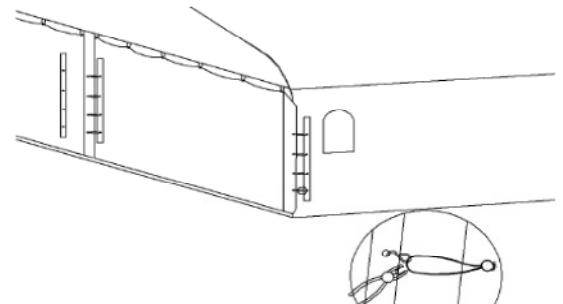

Contact information

Head office:

Dancover A/S
Nordre Strandvej 119 G
3150 Hellebæk
Denmark

For more information
please visit:
www.dancovershop.com

National contact

Denmark:

denmark@dancover.com

UK:

uk@dancover.com

Germany:

germany@dancover.com

France:

france@dancover.com

Sweden:

sverige@dancover.com

Finland:

suomi@dancover.com

Poland:

polska@dancover.com

Luxembourg:

luxembourg@dancover.com

Spain:

espana@dancover.com

Italy:

italia@dancover.com

Switzerland:

schweiz@dancover.com

Austria:

austria@dancover.com

Norway:

norge@dancover.com

Nederland:

nederland@dancover.com

Ireland:

ireland@dancover.com

Belgium:

belgique@dancover.com