

DANCOVER[®]



PARTY TENT SEMI PRO

7x7-2.3m

DANCOVER[®]



Safety Advice

Attention

In some countries approval is needed to set up a tent larger than 75 m².

The owner of the tent has the sole responsibility to make sure that these local rules are followed and that the mounting is correct.

In case of bad weather conditions, it is your responsibility to ensure that people inside are safe and that the tent does not cause damage to others.

Do not use open fire, welding equipment or other ignition sources in the tent. Though the fabric is made of flame retardant material it can still burn.











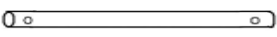







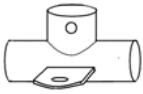
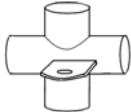

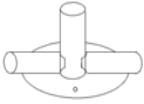
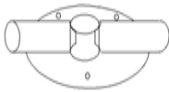



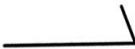

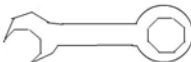
It is always recommended that you secure your tent properly with safety straps and augers when you put up the structure.

We recommend you to insure the tent, or check if it is covered by home contents insurance, in case of unplanned events, accidents or bad weather.

Tents are meant as temporary shelter and must be evacuated under extreme weather conditions.

This structure is not tested for specific snow and wind loads. That's why we always recommend to remove snow from the top.

7x7m-2.3 PARTY TENT SEMI PRO

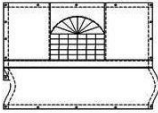
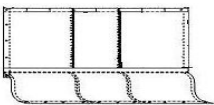
													
1.	8PCS	2.	27PCS	3.	16PCS	4.	4PCS	5.	8PCS	6.	4PCS	7.	2PCS
													
8.	2PCS	9.	4PCS	10.	4PCS	11.	4PCS	12.	2PCS	13.	2PCS	14.	4PCS
													
15.	4 pc	16.		4PCS		17.		4PCS		18.super peg	6pcs	19.spiral peg	4pcs
													
20.middle peg	8 pcs	21.small peg	36 PCS	22.allen key	1PCS	23.spencer	2PCS	24.screw	16PCS	25.nuts	16pcs	26.45mm screw	55pcs
													
27.60mm screw	50pcs	28.locknuts	210pcs	29. long bungeeball	132PCS	30. short bungeeball	16PCS	31.rop	4PCS			33.roof	1 pcs
													
34.sidewall	8PCS	35.endwall	2PCS										

7x7m-2.3 PARTY TENT SEMI PRO

I

Select a flat ground for the tent, unpack the carton and check that all the parts including tubes, tent and accessories... etc. are present as same as list. Assemble the framework of rooftop by joining the portion (6.7.8.9.10.11.) together with poles (2.3). Ensure the screw fixed to every pole tightly

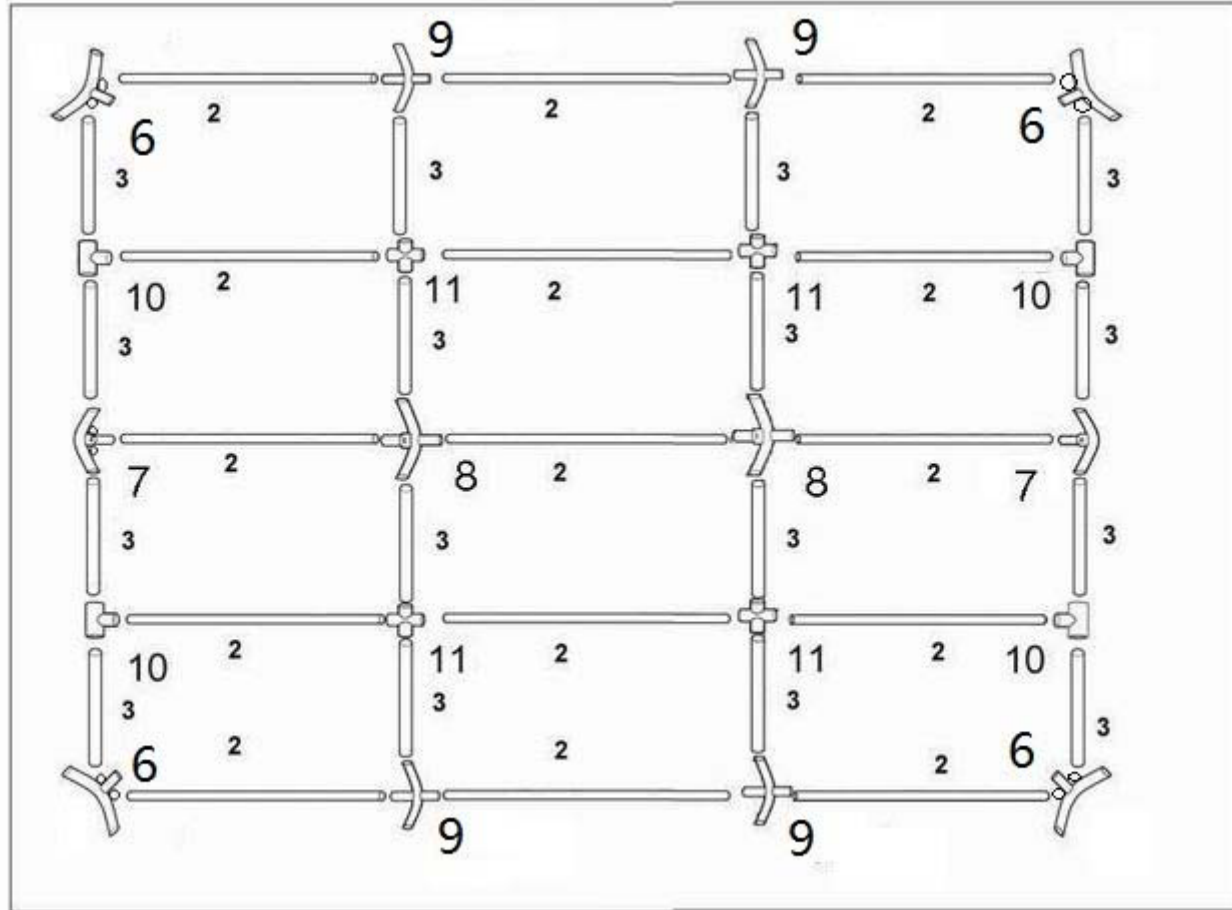

7x7m-2.3 PARTY TENT SEMI PRO

II

Attach one end of supported pole (4.5) to the joints (7.8) ,Strengthen the frame by using screws and turnbuckle set (17 .) .Long screws are used on all connection between 50mm and 54mm pipe .Short screw are used on connection between 42mm and 38mm pipes .

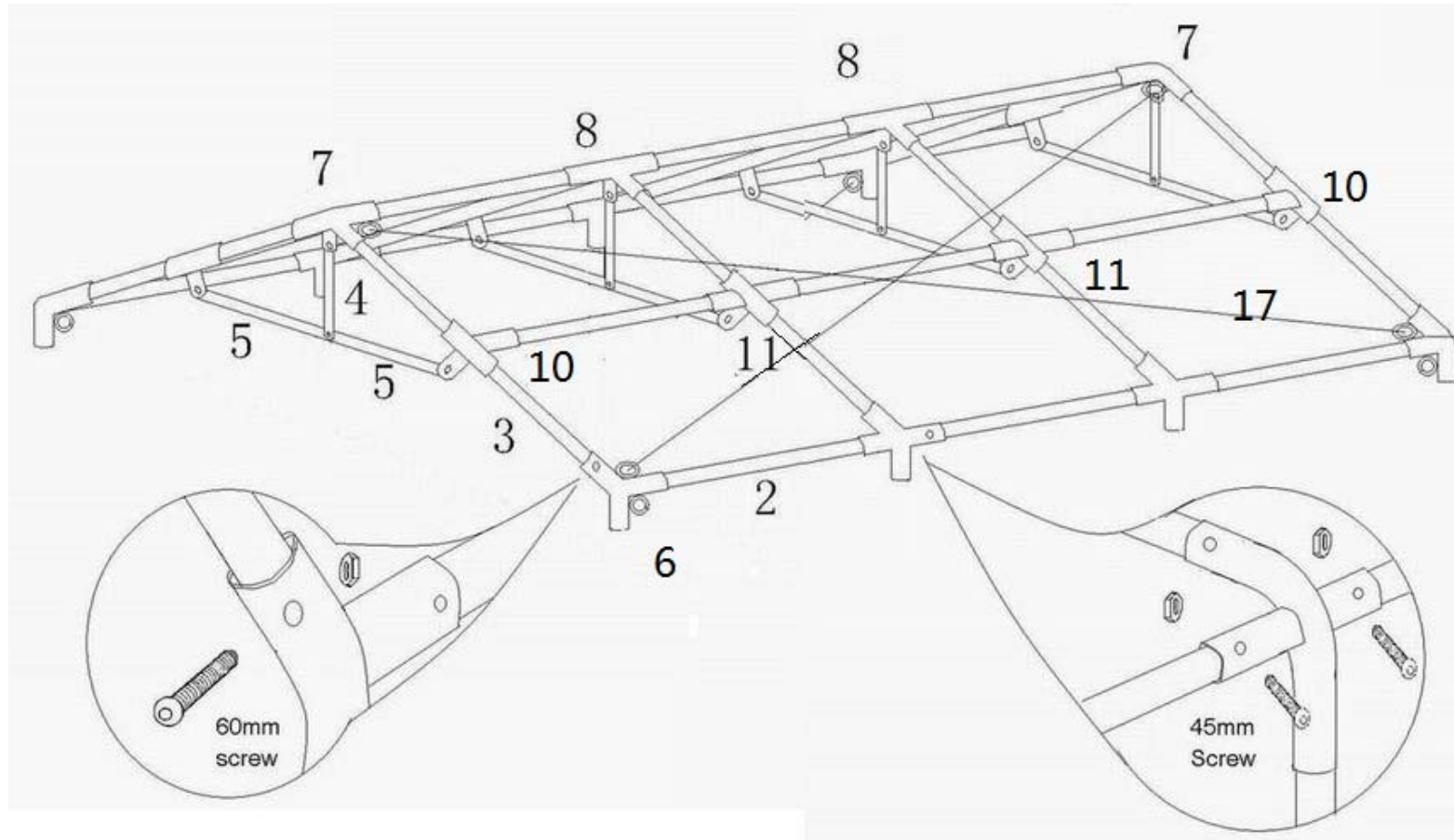

7x7m-2.3 PARTY TENT SEMI PRO

III

Cover the roof on the frame and attach it with the bungee balls. Take care of the tension of the bungee balls, if you use too many on one side of the tent, it may be too tight to tie the other side. Leg 1 with holes, should be on both sides of the tent.

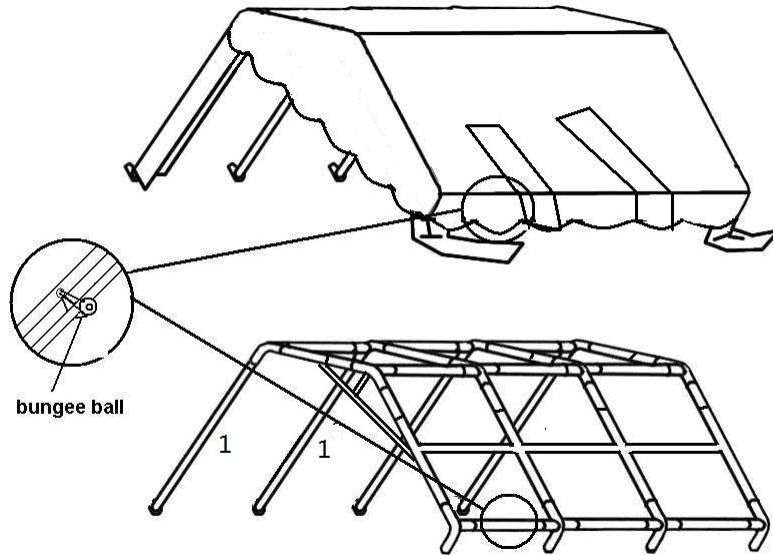

IV

Attach all 8 supported poles (1) to the joints (6.9), built-up the framework use the super pegs to fix the poles into the ground. Tighten the frame with the turnbuckle set (16).

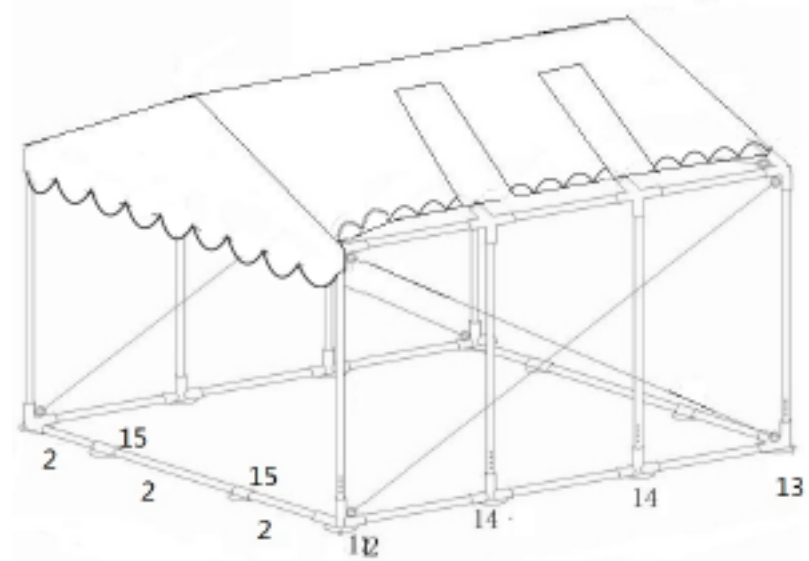

7x7m-2.3 PARTY TENT SEMI PRO

V

Spread the wall panel and door panel. Attach it to the framework by using the bungee balls clasping the frame to grommets over the wall panel and door panel to ensure stability. Use the short pegs to fix the doors to the ground. Connect leg cover with sidewall and endwall by velcro as shown.

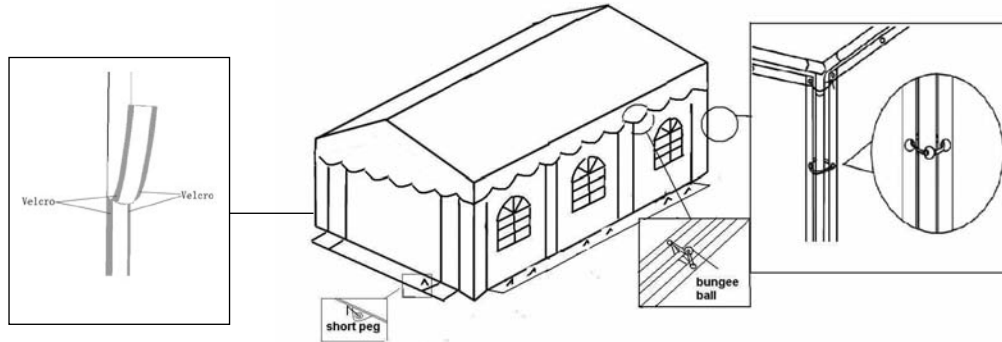

VI

Clasp the guy lines to each corner of the tent. Fix the other end of the line to the ground with pegs.

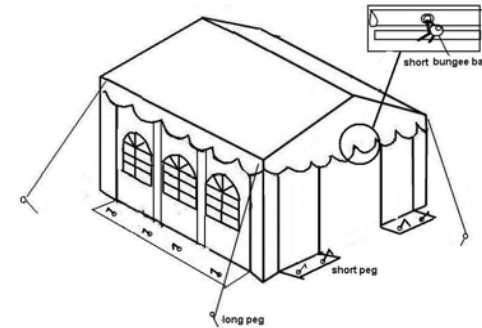

Warning

1. In order to avoid rust on the pipes, oil is covered on the surface. Before you set up the tent, please remove the oil carefully to keep the cover clean.
 2. Take note that the tent needs to be handled carefully to avoid damage.
 3. Do not force the frame as it may be damaged in the process.
 4. Tents are meant as temporary shelter and must be evacuated under extreme weather conditions.
- Please select a suitable site for the tent to avoid damage to underground sprinkler systems, water, gas or electrical lines

Contact information

Head office:

Dancover A/S
Nordre Strandvej 119 G
3150 Hellebæk
Denmark

For more information
please visit:
www.dancovershop.com

National contact

Denmark:

denmark@dancover.com

UK:

uk@dancover.com

Germany:

germany@dancover.com

France:

france@dancover.com

Sweden:

sverige@dancover.com

Finland:

suomi@dancover.com

Poland:

polska@dancover.com

Luxembourg:

luxembourg@dancover.com

Spain:

espana@dancover.com

Italy:

italia@dancover.com

Switzerland:

schweiz@dancover.com

Austria:

austria@dancover.com

Norway:

norge@dancover.com

Nederland:

nederland@dancover.com

Ireland:

ireland@dancover.com

Belgium:

belgique@dancover.com