

**DANCOVER<sup>®</sup>**



Manual  
for  
Marquee Partyzone  
6x6m PVC

# DANCOVER<sup>®</sup>

.com

## Safety Advice

### Attention

In some countries approval is needed to set up a marquee/tent larger than 75 m<sup>2</sup>. It is your responsibility to comply with local rules and regulations and to ensure that the marquee/tent is assembled correctly.

In case of bad weather conditions, it is your responsibility to ensure the marquee/tent is safely secured and that the marquee/tent does not cause damage to others.

Do not use open fire, welding equipment or other sources which can ignite, inside or close to the tent.

The marquee/tent must be safely secured. We recommend you secure your marquee/tent with straps and pegs as soon as it is assembled.

Make sure to check if the marquee/tent is covered by your home contents insurance.

Marquees/tents must be evacuated under extreme weather conditions.

In the event of snow, always remove snow from the roof of the marquee/tent regularly to prevent snow from building on the roof, as heavy snow can cause the marquee/tent to collapse.

In the event of rain, there is a risk of rain puddles building up on top of the roof of the marquee/tent. Heavy rain puddles can cause the roof to collapse. It is your responsibility to ensure rain puddles do not build up. As a precaution, make sure the roof of the marquee/tent is stretched out properly and adequately over the side frames of the marquee/tent and remove rain water regularly.

Do not unpack or repack your marquee/tent in freezing temperatures. In case of temperatures below zero, always unpack and repack your marquee/tent indoors to avoid the risk of cracking parts.









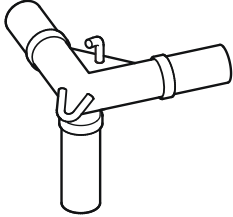

The marquee/tent must be totally dry before you repack and store it to avoid mildew.

**Note:** Marquees are intended for events and other arrangements and are as such only meant for short term temporary assembly and the following disassembly. Dancover warranty applies only to the normal use of the Product, normal wear and tear excepted, in accordance with written use instructions or manual. The warranty does not apply to damage caused by accident, abuse, misuse, or modification of the Product.

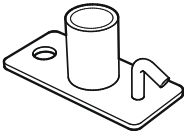
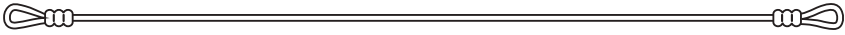
### Warranty Information

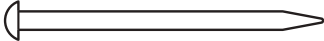
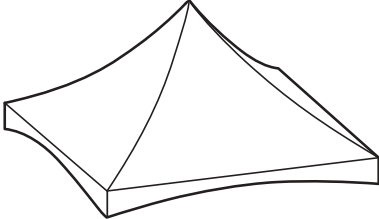
Please visit [dancovershop.com](http://dancovershop.com) for information on warranty.

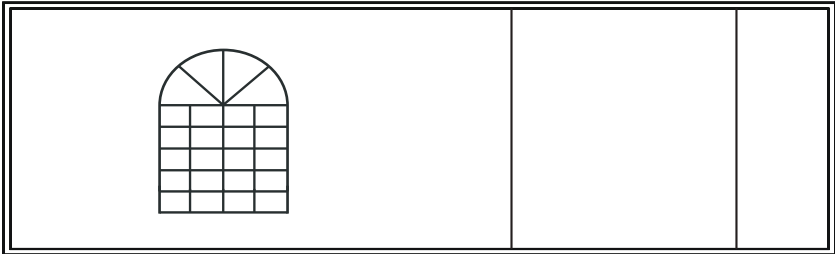
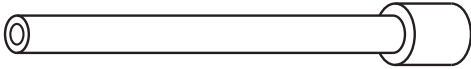
*Please always check our website for the latest safety advice and manual.*

Part No.	Description	Picture	Quantity
1	Eave Pole		8
2	Leg Pole		4
3	Center Pole		1
4 / A	Corner Joint		4
5 / B	Sleeve		4
6 / C	Foot pad		4
7	Cross Cable		2
8	Ratchet Rope		4
9	Peg		8
11	Roof		1
12	Sidewall		3
13	Sidewall with zipper		1
14	Flag Pole		1
15	Ratchet Stape		4

# Frame sketch

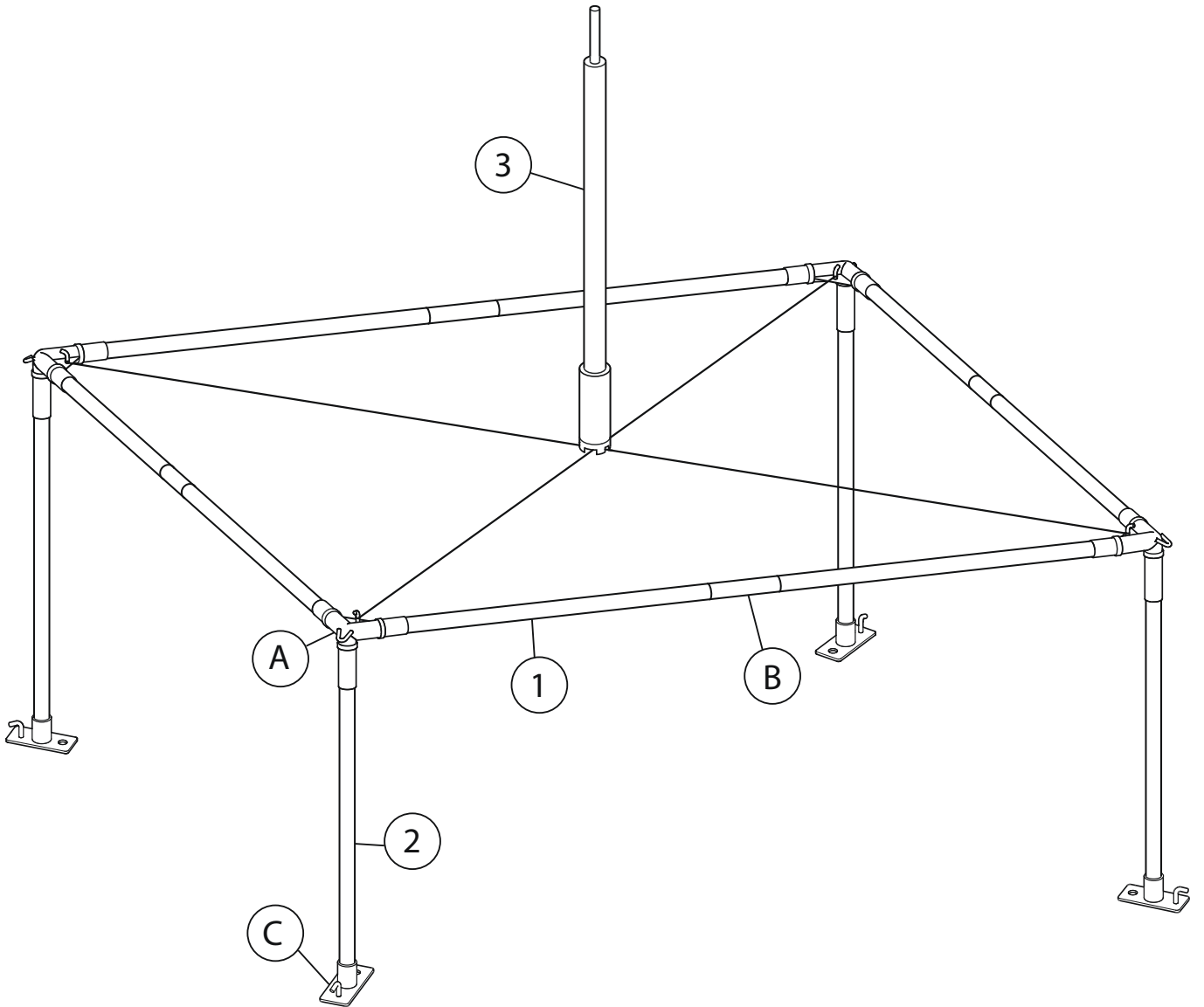

# Assembly

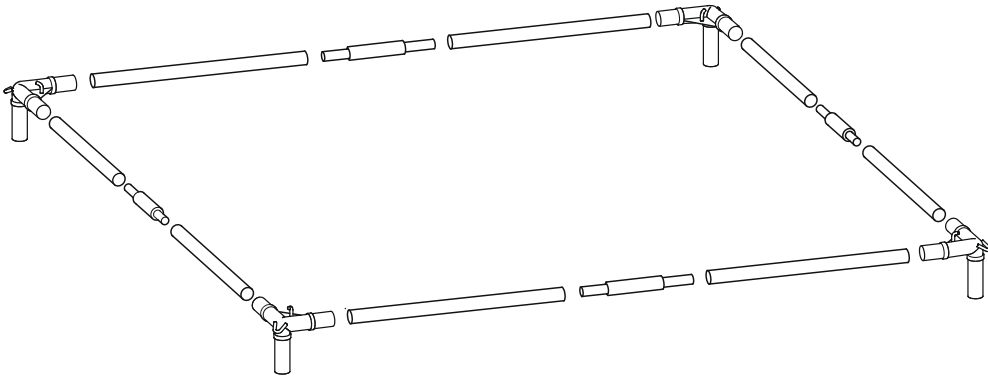

**Step 1:** Lay all the parts on the ground as shown.

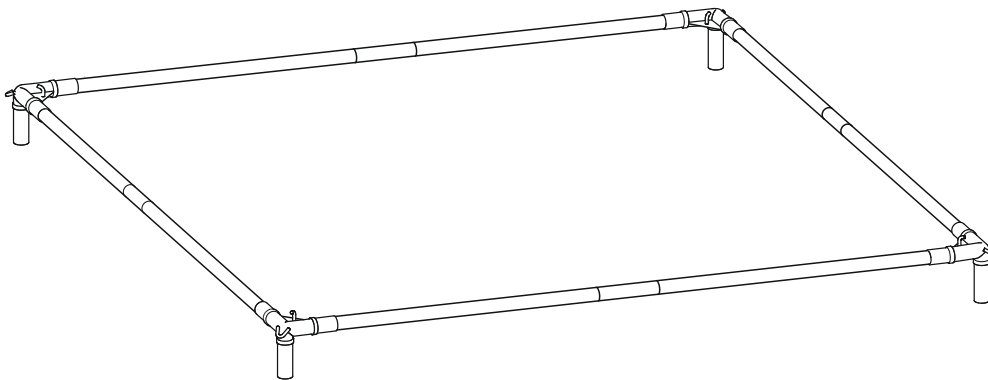

**Step 2:** Put all the joints and poles together.

# Assembly

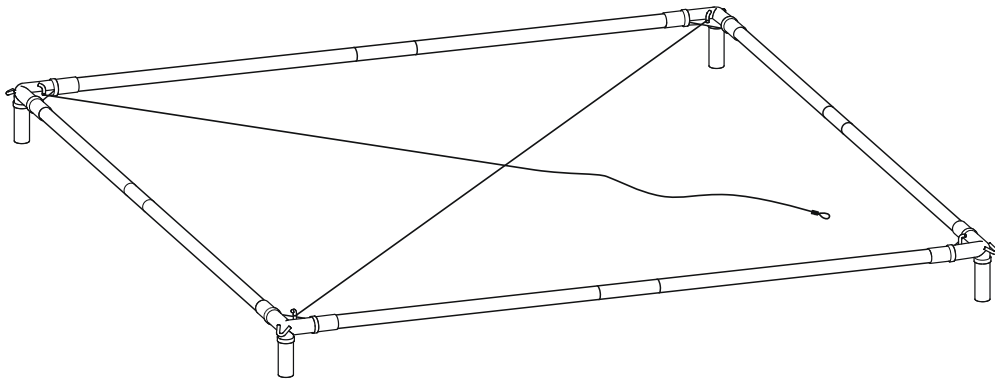

**Step 3:** Install one cross cable.

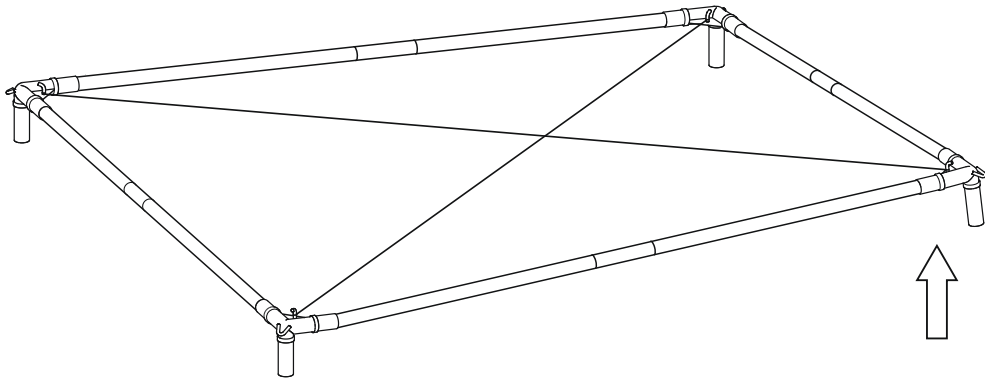

**Step 4:** Lift the left corner and suspend another cable.

# Assembly

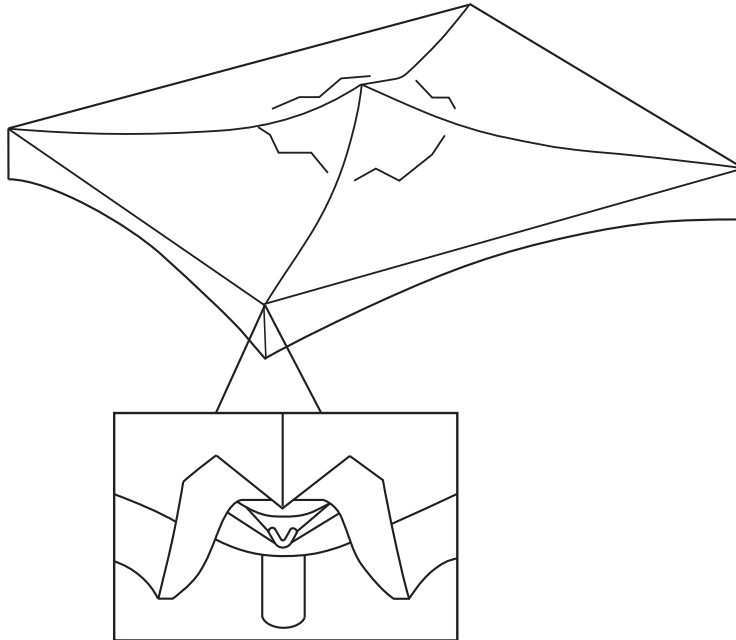

**Step 5:** Assembly the roof cover, pull the corner with handle.

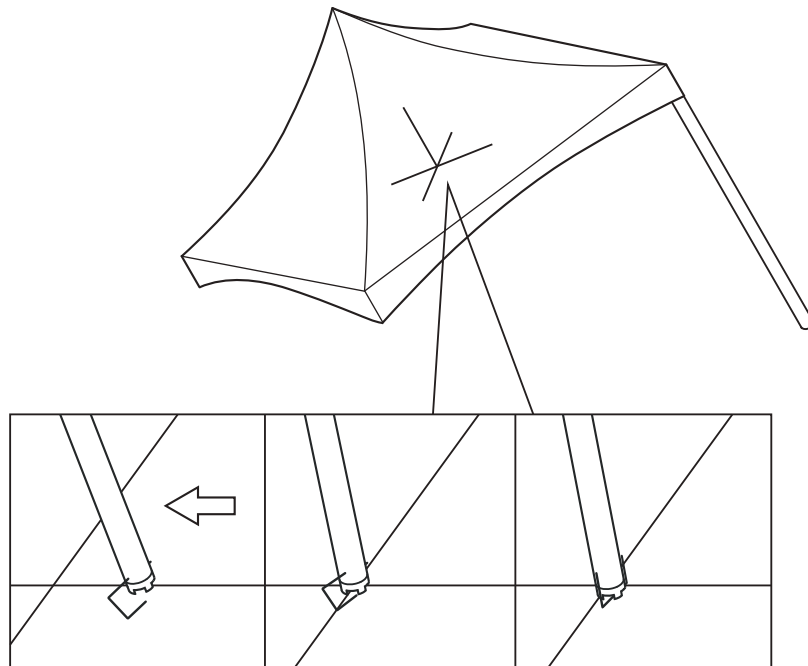

**Step 6:** Push the vertical pole upright.

# Assembly

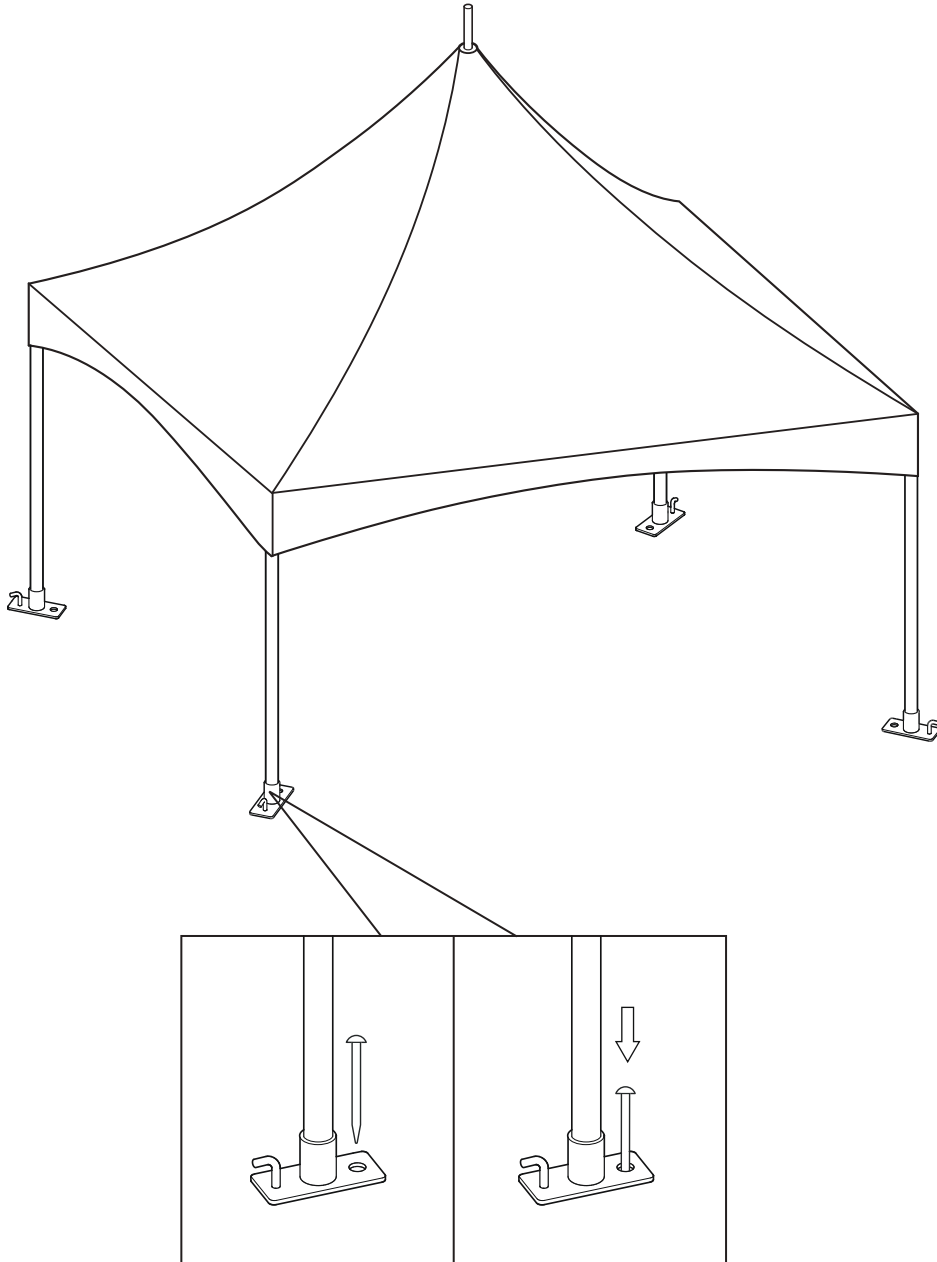

**Step 7:** Insert all the legs to make the tent stand up.

**Note:** use pegs to fix the tent on the ground



# Assembly

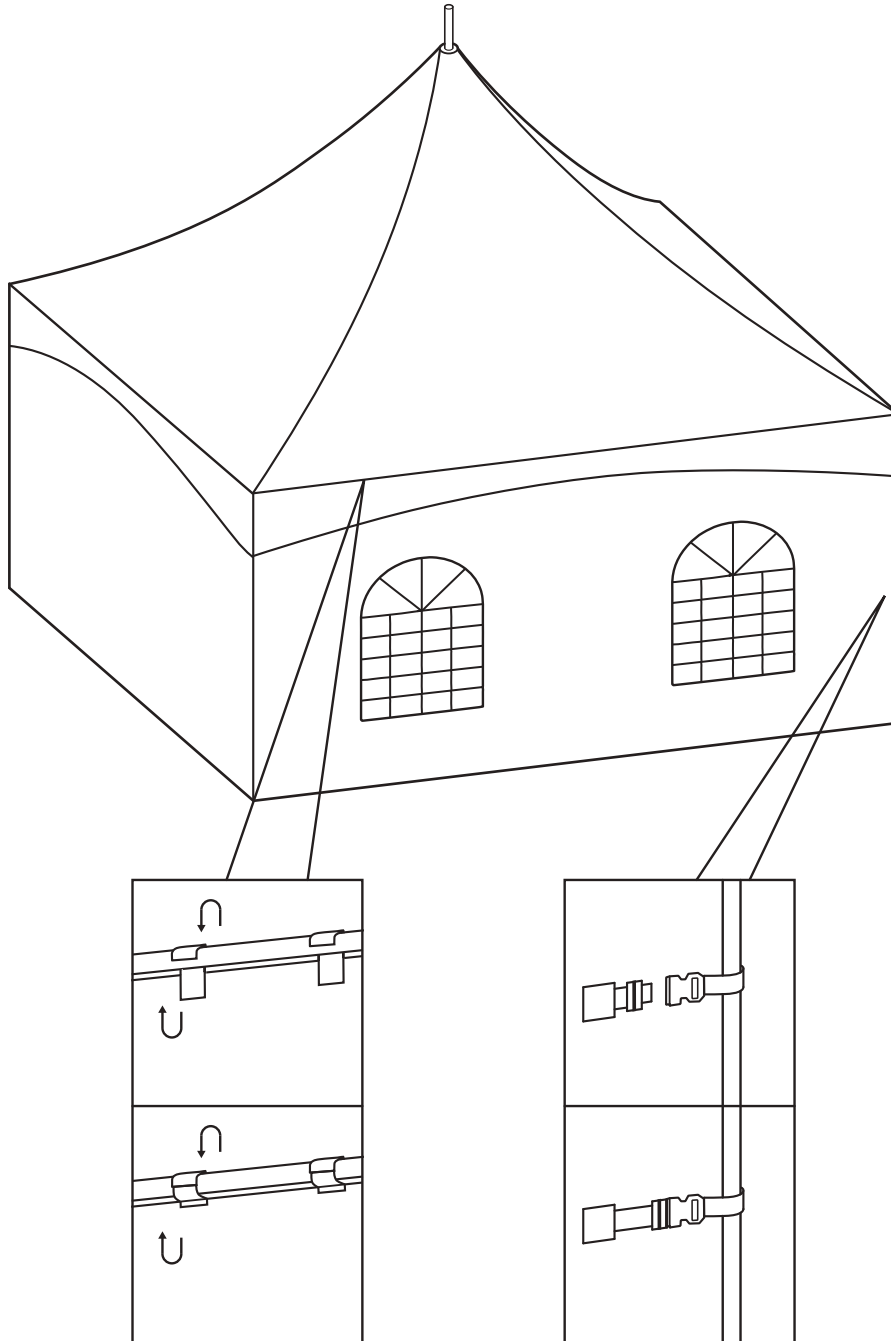

**Step 8:** Suspend all the sidewalls.

**Note:** use the buckles fix the sidewall on the frame

# Assembly

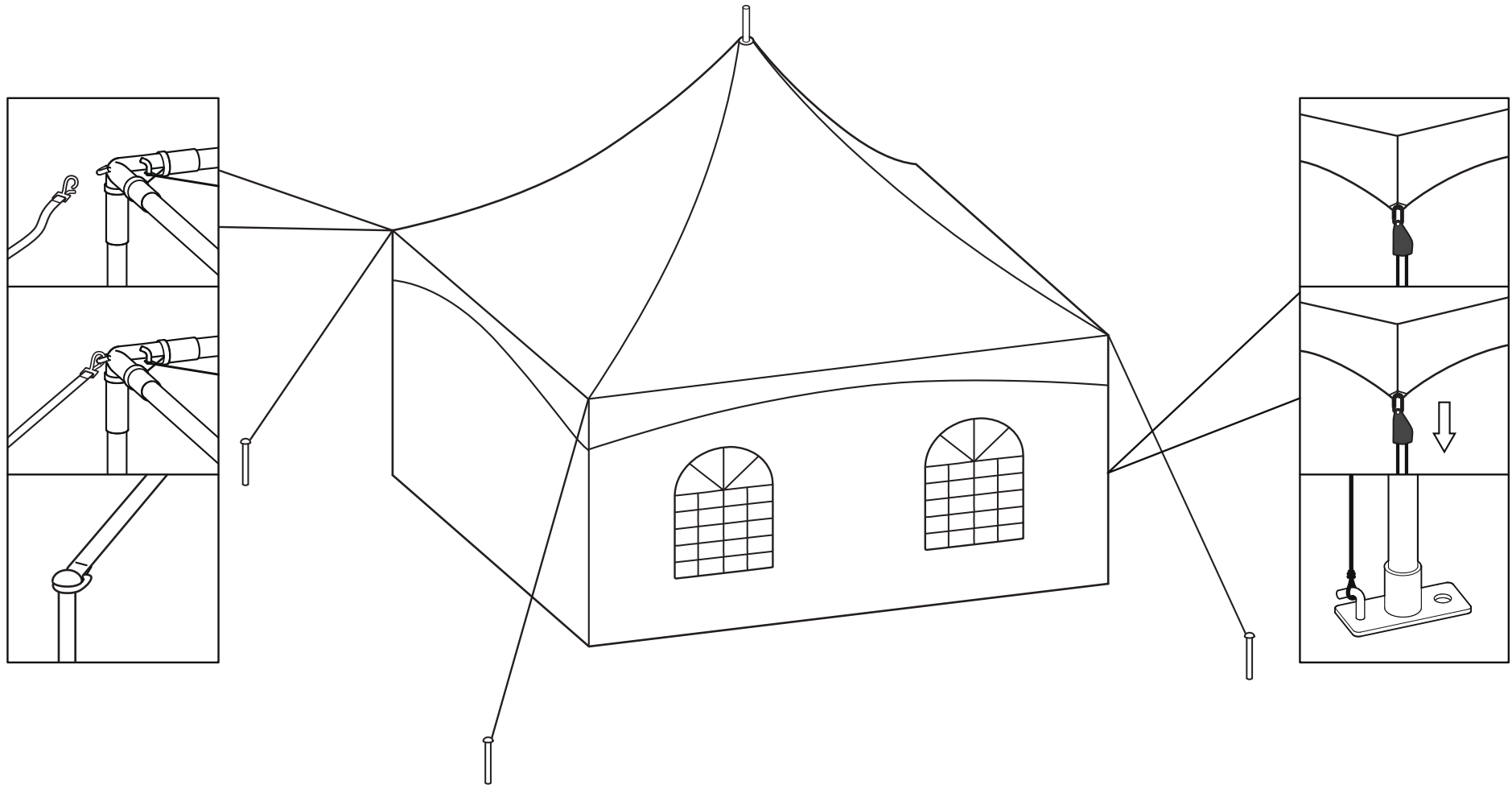

**Step 9:** Fasten the roof tensioning ropes and use the roof tensioning straps make the tent more stable.

# DANCOVER<sup>®</sup>

.com

## Contact information

### Head office:

Dancover A/S  
Nordre Strandvej 119 G  
3150 Hellebæk  
Denmark

For more information  
please visit:  
[www.dancovershop.com](http://www.dancovershop.com)

## National contact

Denmark: 70 26 76 20  
[denmark@dancover.com](mailto:denmark@dancover.com)

UK: 020 8099 7570  
[uk@dancover.com](mailto:uk@dancover.com)

Germany: 041 0266 7040  
[germany@dancover.com](mailto:germany@dancover.com)

France: 0975 181 800  
[france@dancover.com](mailto:france@dancover.com)

Sweden: 040 233 262  
[sverige@dancover.com](mailto:sverige@dancover.com)

Finland: 0 931 581 720  
[suomi@dancover.com](mailto:suomi@dancover.com)

Poland: 22 300 8602  
[polska@dancover.com](mailto:polska@dancover.com)

Luxembourg: +49 041 0266 7040  
[luxembourg@dancover.com](mailto:luxembourg@dancover.com)

Portugal: 308 800 899  
[portugal@dancover.com](mailto:portugal@dancover.com)

Spain: 911 436 828  
[espana@dancover.com](mailto:espana@dancover.com)

Italy: 02 479 21 198  
[italia@dancover.com](mailto:italia@dancover.com)

Switzerland: 0840 000125  
[schweiz@dancover.com](mailto:schweiz@dancover.com)

Austria: 0662 626935  
[austria@dancover.com](mailto:austria@dancover.com)

Norway: 231 00 690  
[norge@dancover.com](mailto:norge@dancover.com)

Nederland: 0 858 880 524  
[nederland@dancover.com](mailto:nederland@dancover.com)

Ireland: 0 151 33 003  
[ireland@dancover.com](mailto:ireland@dancover.com)

Belgium: 0 28 08 08 09  
[belgique@dancover.com](mailto:belgique@dancover.com)