

DANCOVER[®]

.com

Manual
Pagoda
4x4m

DANCOVER[®]

.com

Safety Advice

Attention

In some countries approval is needed to set up a marquee/tent larger than 75 m². It is your responsibility to comply with local rules and regulations and to ensure that the marquee/tent is assembled correctly.

In case of bad weather conditions, it is your responsibility to ensure the marquee/tent is safely secured and that the marquee/tent does not cause damage to others.

Do not use open fire, welding equipment or other sources which can ignite, inside or close to the tent.

The marquee/tent must be safely secured. We recommend you secure your marquee/tent with straps and pegs as soon as it is assembled.

Make sure to check if the marquee/tent is covered by your home contents insurance.

Marquees/tents must be evacuated under extreme weather conditions.

In the event of snow always remove snow from the roof of the marquee/tent regularly to prevent snow from building on the roof as heavy snow can cause the marquee/tent to collapse.

In the event of rain there is a risk of rain puddles building up on top of the roof of the marquee/tent. Heavy rain puddles can cause the roof to collapse. It is your responsibility to ensure rain puddles do not build up. As a precaution, make sure the roof of the marquee/tent is stretched out properly and adequately over the side frames of the marquee/tent and remove rain water regularly.

Do not unpack or repack your marquee/tent in freezing temperatures. In case of temperatures below zero always unpack and repack your marquee/tent indoors to avoid the risk of cracking parts.

The marquee/tent must be totally dry before you repack and store it to avoid mildew.









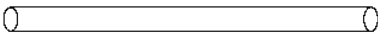

Note: Marquees are intended for events and other arrangements and are as such only meant for short term temporary assembly and the following disassembly. Dancover warranty applies only to the normal use of the Product, normal wear and tear excepted, in accordance with written use instructions or manual. The warranty does not apply to damage caused by accident, abuse, misuse, or modification of the Product.

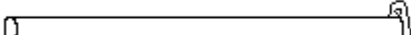
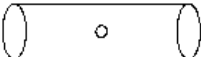
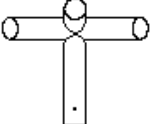
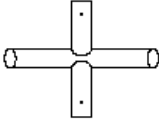
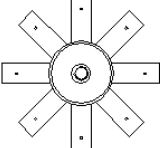
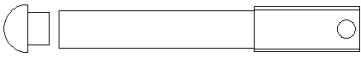
Warranty Information

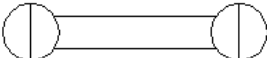



Please visit dancovershop.com for information on warranty.

Please always check our website for the latest safety advice and manual.

Part List

| Part NO. | Part | 4x4m | | |
|----------|---|------|--|--|
| 1 |  | 4 | | |
| 2 |  | 4 | | |
| 3 |  | 8 | | |
| 4 |  | 8 | | |
| 5 |  | 4 | | |
| 6 |  | 4 | | |
| 7 |  | 4 | | |
| 8 |  | 1 | | |
| 10 |  | 1 | | |
| 11 |  | 4 | | |
| 12 |  | 1 | | |
| 13 |  | 8 | | |
| 14 |  | 4 | | |
| 15 |  | 42 | | |
| 16 |  | 8 | | |
| 17 |  | 64 | | |
| 18 |  | 32 | | |

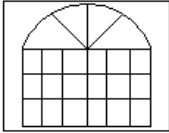
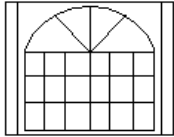
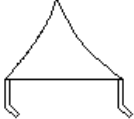
Part List

| | | | | | |
|----|--------------|---|---|--|--|
| 19 | M30 |  | 1 | | |
| 20 | M8X50 |  | 4 | | |
| 21 | M8 |  | 4 | | |
| 22 | |  | 4 | | |
| 23 | |  | 4 | | |
| 24 | |  | 1 | | |
| 25 | |  | 4 | | |

Assembly

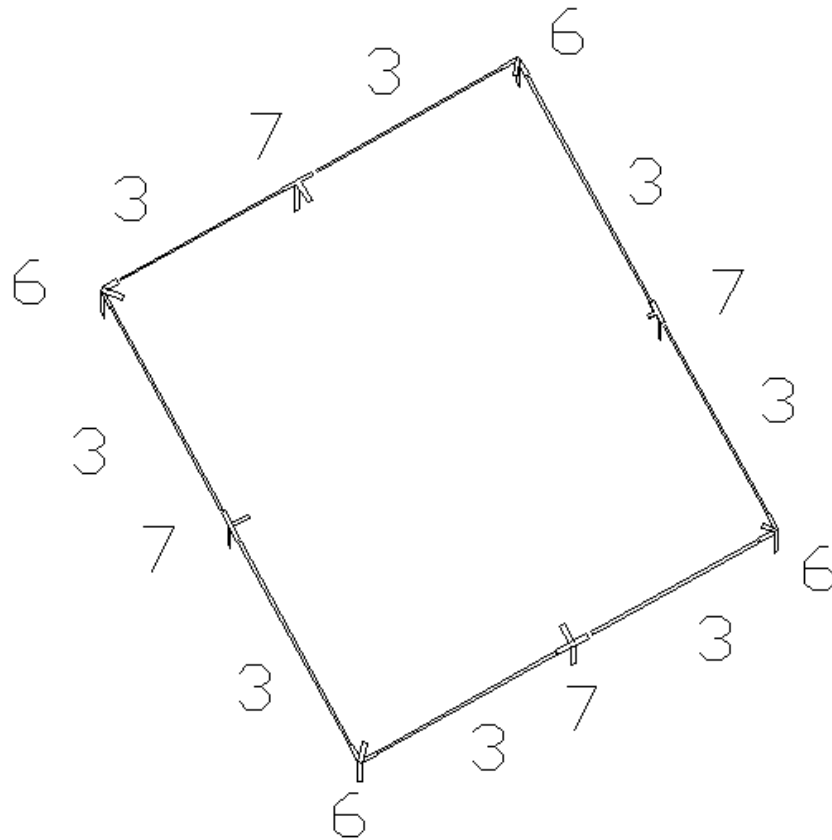

Step1: Lay out and connect the square as shown above.

Step2: Fasten the connections.

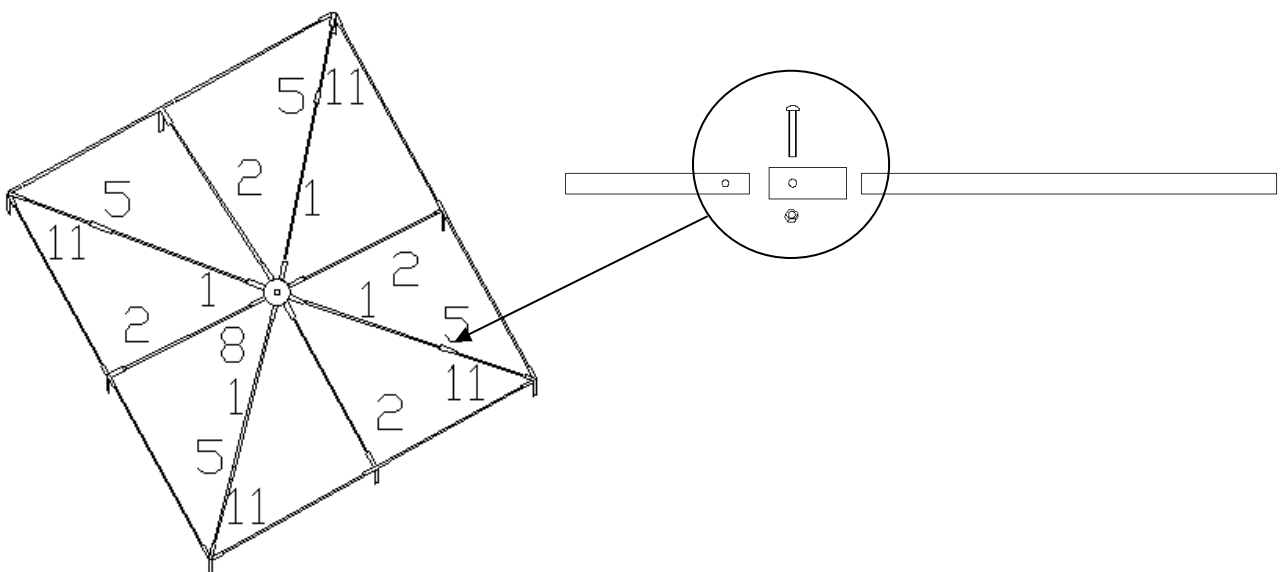

Assembly

Step3: Set up the top as shown above. NO.1 and 11 assembled by NO.5.

Step4: Put NO.10 through the top rings (NO.8)

Step5: Put the roofcover (NO.24) on the roof structure.

Step6: Use the legs to raise the top one side at a time.

Step7: Secure the legs to the ground with the stake pegs (NO.13).

Step8: Fasten roofcover (NO.24) with bungee balls (NO.17).

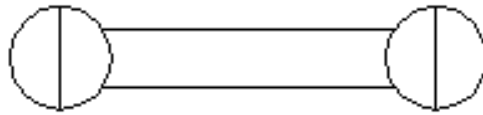

NO.12

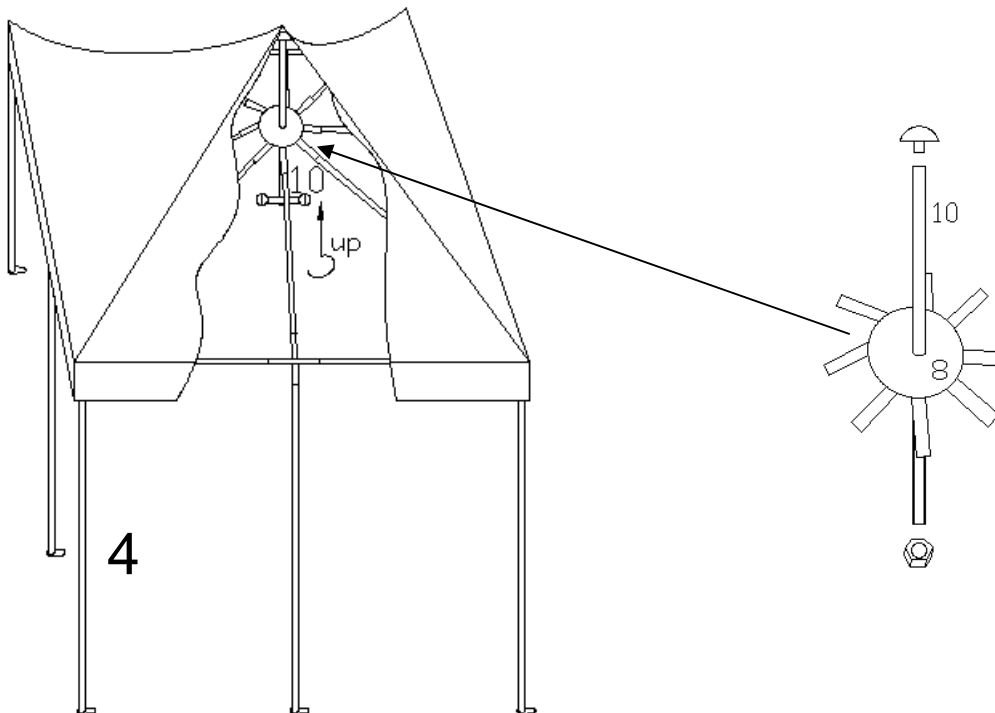

Assembly

Step9: Use NO.12 to tighten the roofcover as shown above and fasten with NO.19.

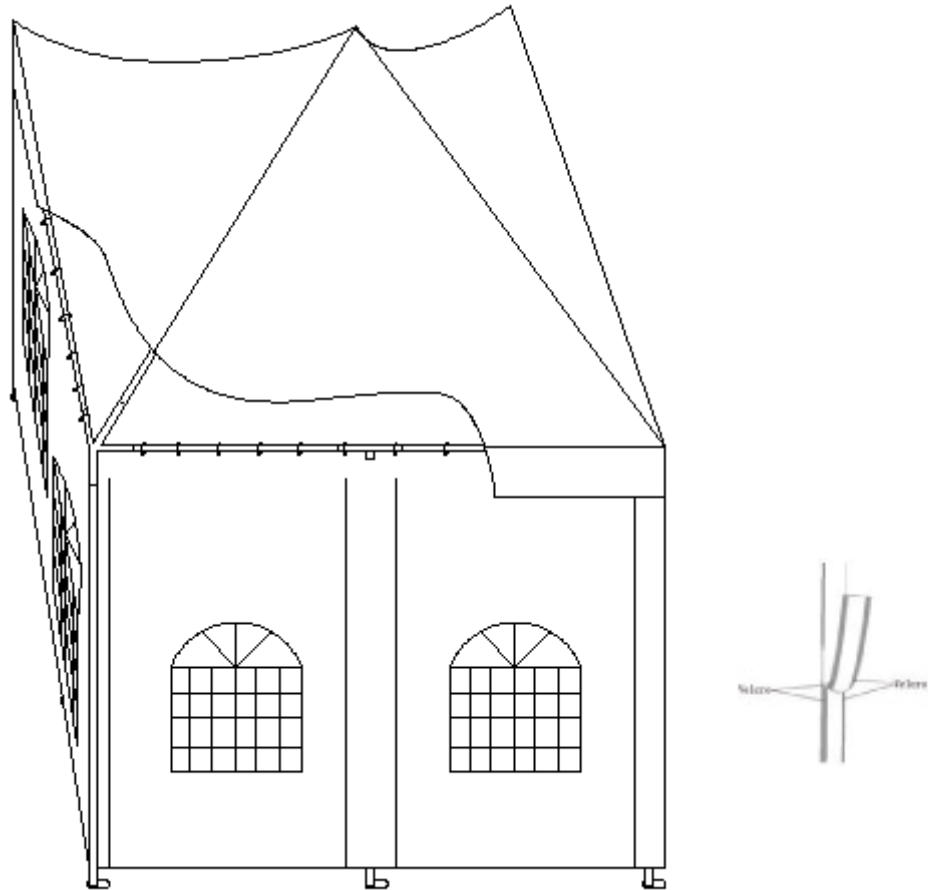

Step10: Connect leg cover with sidewall and endwall by Velcro as shown.

Step11: Use part NO. 16 through the eyelet directly above the zipper and around pipe 3 to keep the zipper aligned.

Contact information

Head office:

Dancover A/S
Nordre Strandvej 119 G
3150 Hellebæk
Denmark

For more information
please visit:
www.dancovershop.com

National contact

Denmark:

denmark@dancover.com

UK:

uk@dancover.com

Germany:

germany@dancover.com

France:

france@dancover.com

Sweden:

sverige@dancover.com

Finland:

suomi@dancover.com

Poland:

polska@dancover.com

Luxembourg:

luxembourg@dancover.com

Spain:

espana@dancover.com

Italy:

italia@dancover.com

Switzerland:

schweiz@dancover.com

Austria:

austria@dancover.com

Norway:

norge@dancover.com

Nederland:

nederland@dancover.com

Ireland:

ireland@dancover.com

Belgium:

belgique@dancover.com