

**DANCOVER<sup>®</sup>**

**.com**

Manual for  
Pagoda Tent Elegance

8,9x6,5m

# DANCOVER<sup>®</sup>

.com

## Safety Advice

### Attention

In some countries approval is needed to set up a marquee/tent larger than 75 m<sup>2</sup>. It is your responsibility to comply with local rules and regulations and to ensure that the marquee/tent is assembled correctly.

In case of bad weather conditions, it is your responsibility to ensure the marquee/tent is safely secured and that the marquee/tent does not cause damage to others.

Do not use open fire, welding equipment or other sources which can ignite, inside or close to the tent.

The marquee/tent must be safely secured. We recommend you secure your marquee/tent with straps and pegs as soon as it is assembled.

Make sure to check if the marquee/tent is covered by your home contents insurance.

Marquees/tents must be evacuated under extreme weather conditions.

















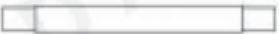



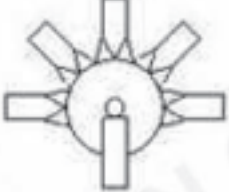

In the event of snow always remove snow from the roof of the marquee/tent regularly to prevent snow from building on the roof as heavy snow can cause the marquee/tent to collapse.

In the event of rain there is a risk of rain puddles building up on top of the roof of the marquee/tent. Heavy rain puddles can cause the roof to collapse. It is your responsibility to ensure rain puddles do not build up. As a precaution, make sure the roof of the marquee/tent is stretched out properly and adequately over the side frames of the marquee/tent and remove rain water regularly.

**Note:** Marquees are intended for events and other arrangements and are as such only meant for short term temporary assembly and the following disassembly. Dancover warranty applies only to the normal use of the Product, normal wear and tear excepted, in accordance with written use instructions or manual. The warranty does not apply to damage caused by accident, abuse, misuse, or modification of the Product.

*Please always check our website for the latest safety advice and manual.*

# Part List

							
<b>No. 01</b>	<b>2</b>	<b>No. 02</b>	<b>1</b>	<b>No. 03</b>	<b>10</b>	<b>No. 04</b>	<b>10</b>
							
<b>No. 05</b>	<b>10</b>	<b>No. 06</b>	<b>10</b>	<b>No. 07</b>	<b>1</b>	<b>No. 08</b>	<b>6</b>
							
<b>No. 09</b>	<b>2</b>	<b>No. 10</b>	<b>2</b>	<b>No. 11</b>	<b>2</b>	<b>No. 12</b>	<b>10</b>
							
<b>No. 13</b>	<b>62</b>	<b>No. 14</b>	<b>2</b>	<b>No. 15</b>	<b>32</b>	<b>No. 16</b>	<b>50</b>
							
<b>No. 17</b>	<b>10</b>	<b>No. 18</b>	<b>1</b>	<b>No. 19</b>	<b>140</b>	<b>No. 20</b>	<b>1</b>
							
<b>No. 21</b>	<b>9</b>	<b>No. 22 Leg curtain</b>	<b>10</b>				

## Warning!:

1. In some countries approval is needed to set up a tent larger than 75 m<sup>2</sup>.
2. The owner of the tent has the sole responsibility to make sure that these local rules are followed and that the mounting is correct.
3. It is always recommended that you secure your tent properly with storm straps and ground pegs when you put up the structure.
4. In case of extreme weather conditions the tent cover must be removed.
5. This structure is not tested for specific snow and wind loads.
6. Do not use open fire, welding equipment or other ignition sources in the tent.
7. We recommend you to insure the tent, or check if it is covered by home contents insurance, in case of unplanned events, accidents or bad weather.

# Assembly

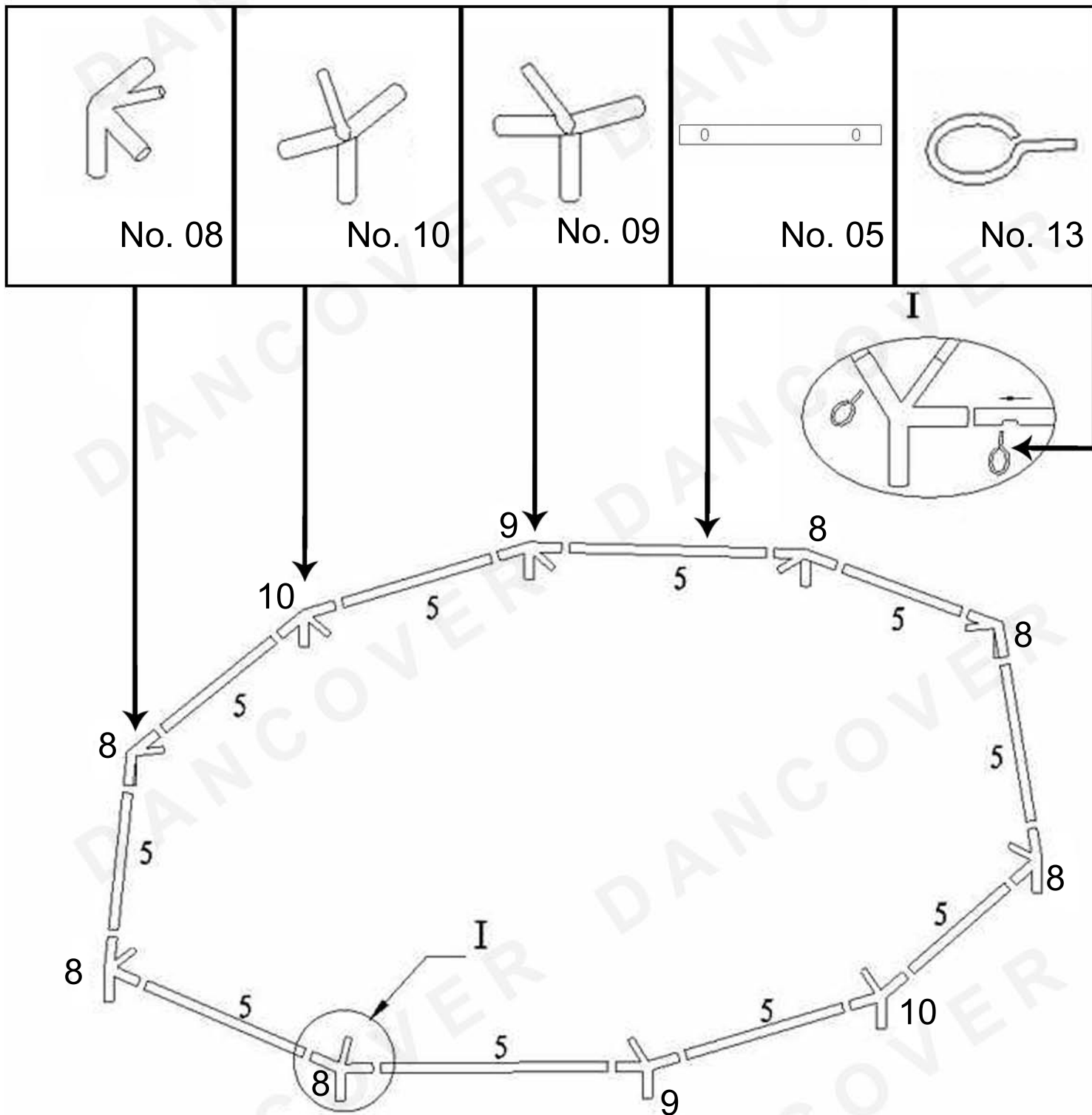

**Step 1:** Lay out the basic shape as shown above.

**Step 2:** Connect the joints and tighten them with screws (No. 13) as shown in I.

# Assembly

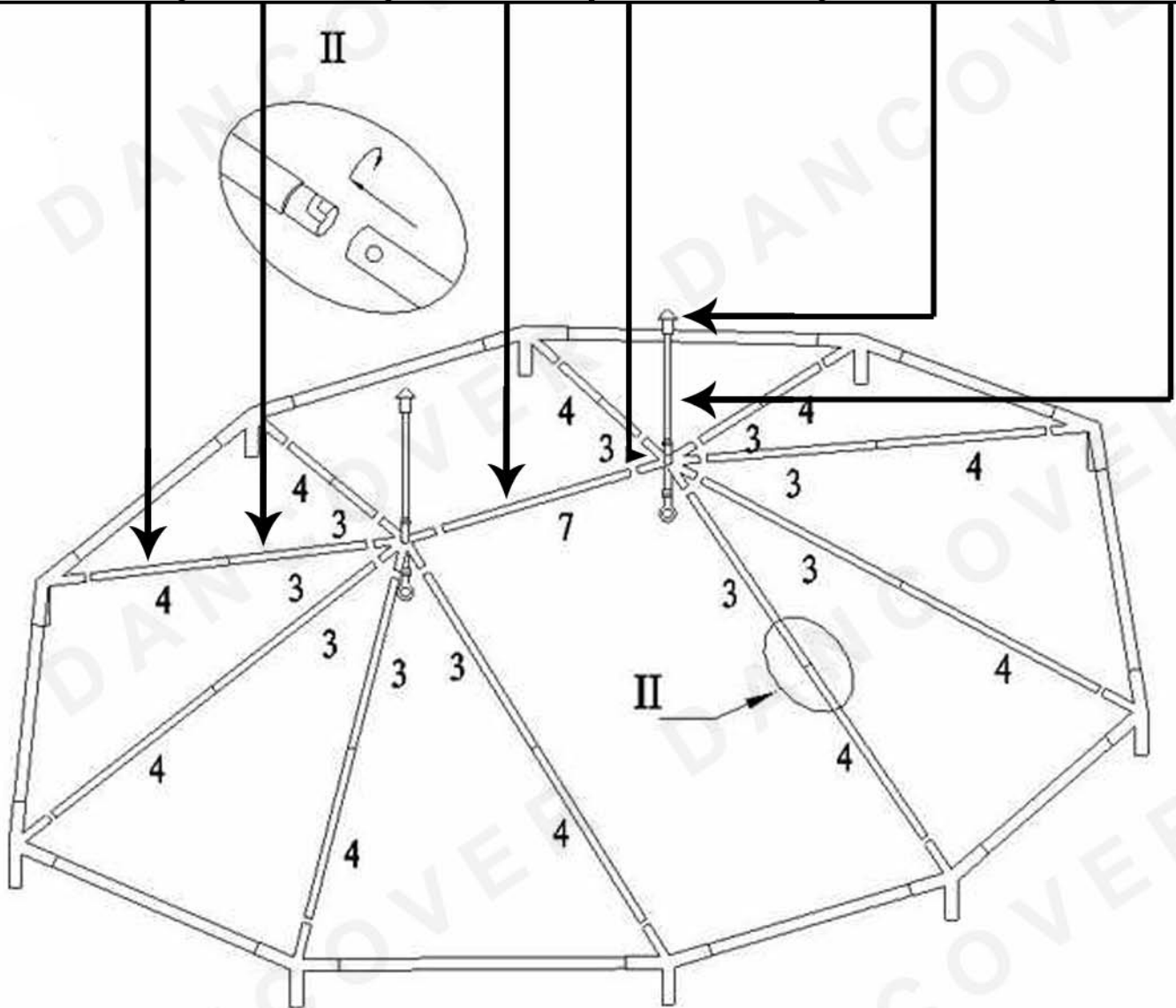
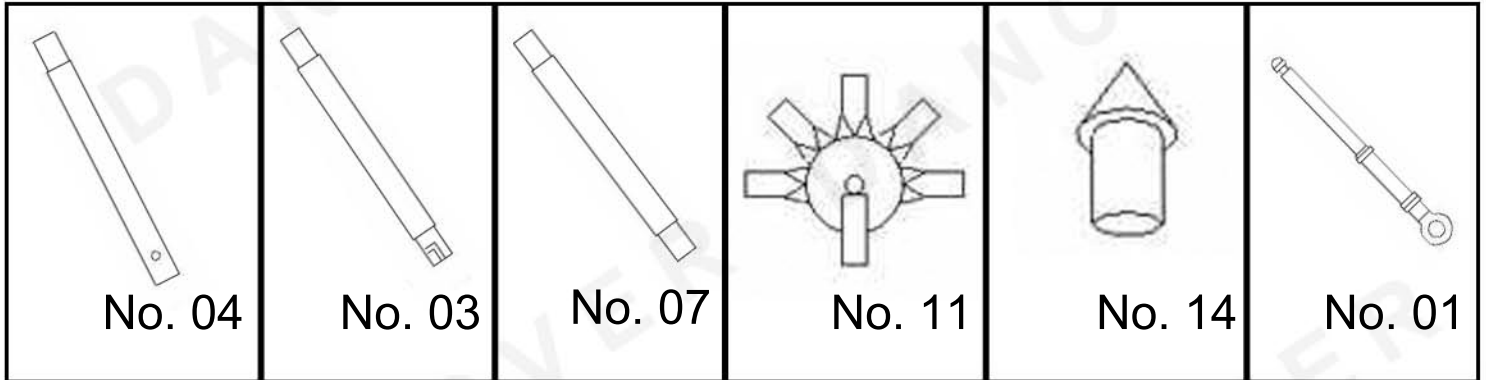

**Step 3:** Assemble the roof as shown above connecting No. 03 & No. 04 as shown in II

**Step 4:** Tighten with screws (No. 13) where it is possible.



# Assembly

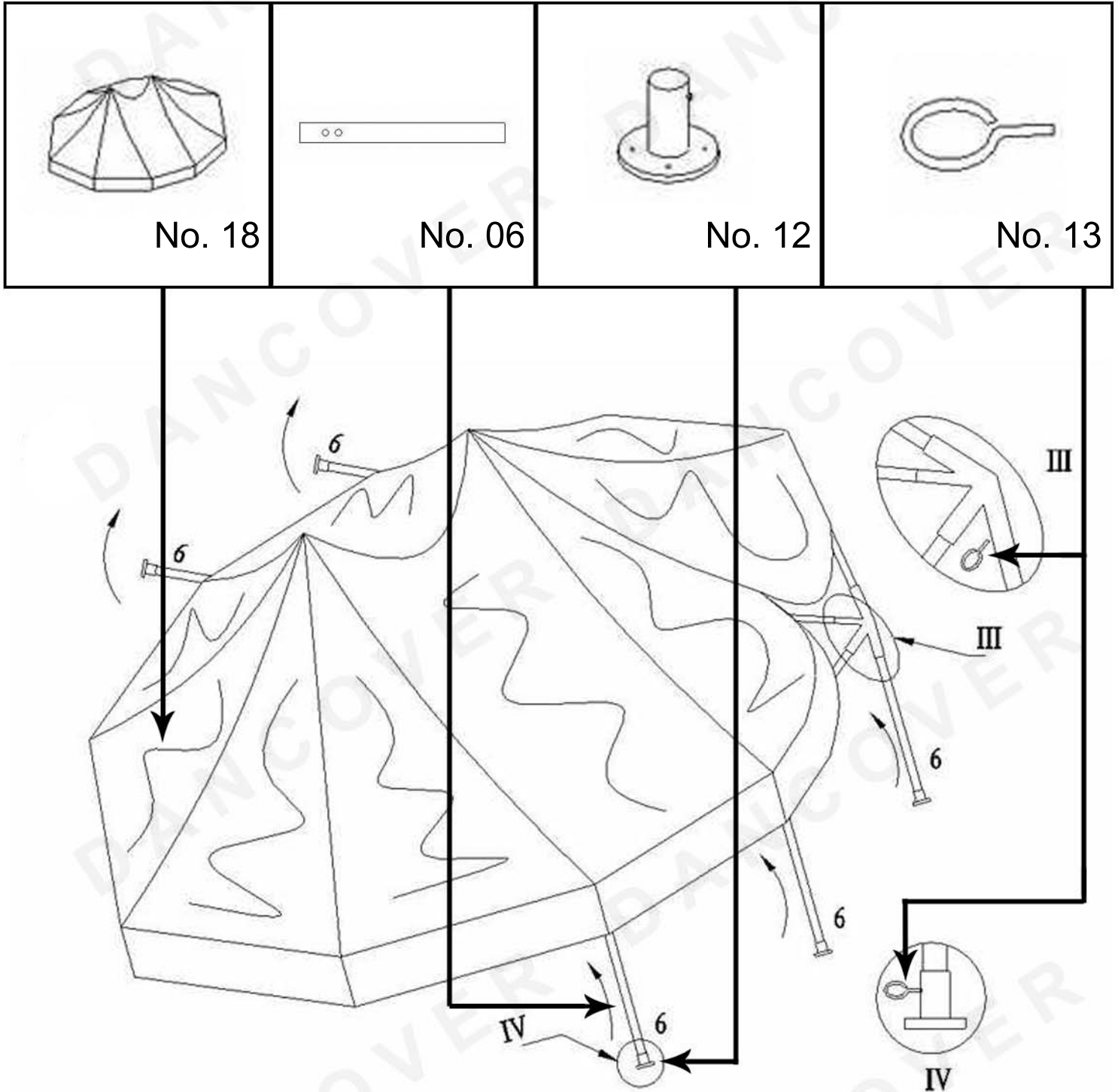

**Step 5:** Put the roofcover on the assembled structure.

**Step 6:** connect the legs and feet as shown in IV. then using the legs raise the structure one side at a time.

# Assembly

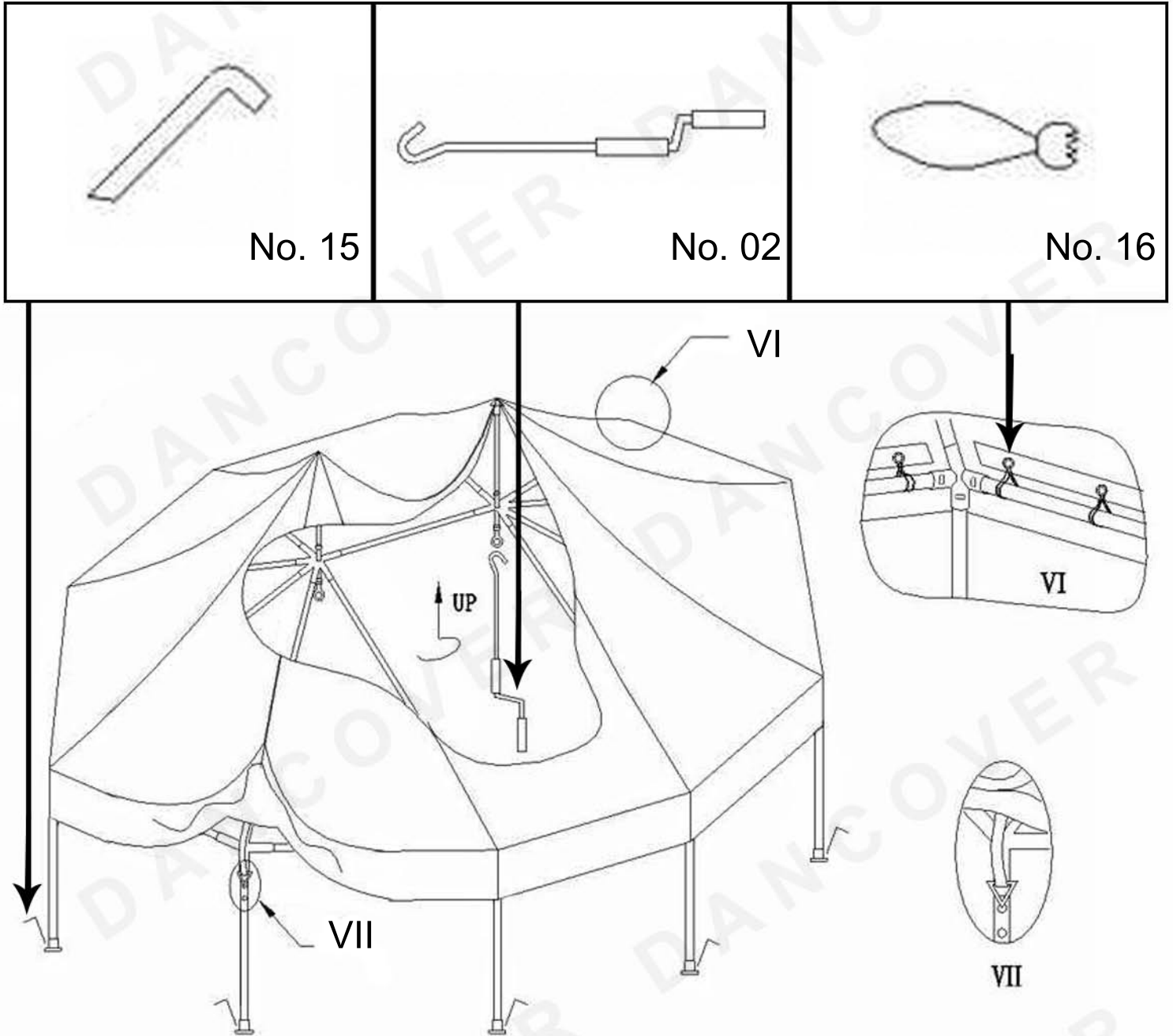

**Step 7:** Secure the structure to the ground using the stake pegs (No. 15).

**Step 8:** secure the roofcover to the structure using bungee balls (No. 16) as shown in VI and the straps by the corners as shown in VII

**Step 9:** Tighten the roofcover by rotating the top spikes using the crank (No. 02) as shown above.

**DANCOVER**®



# Assembly

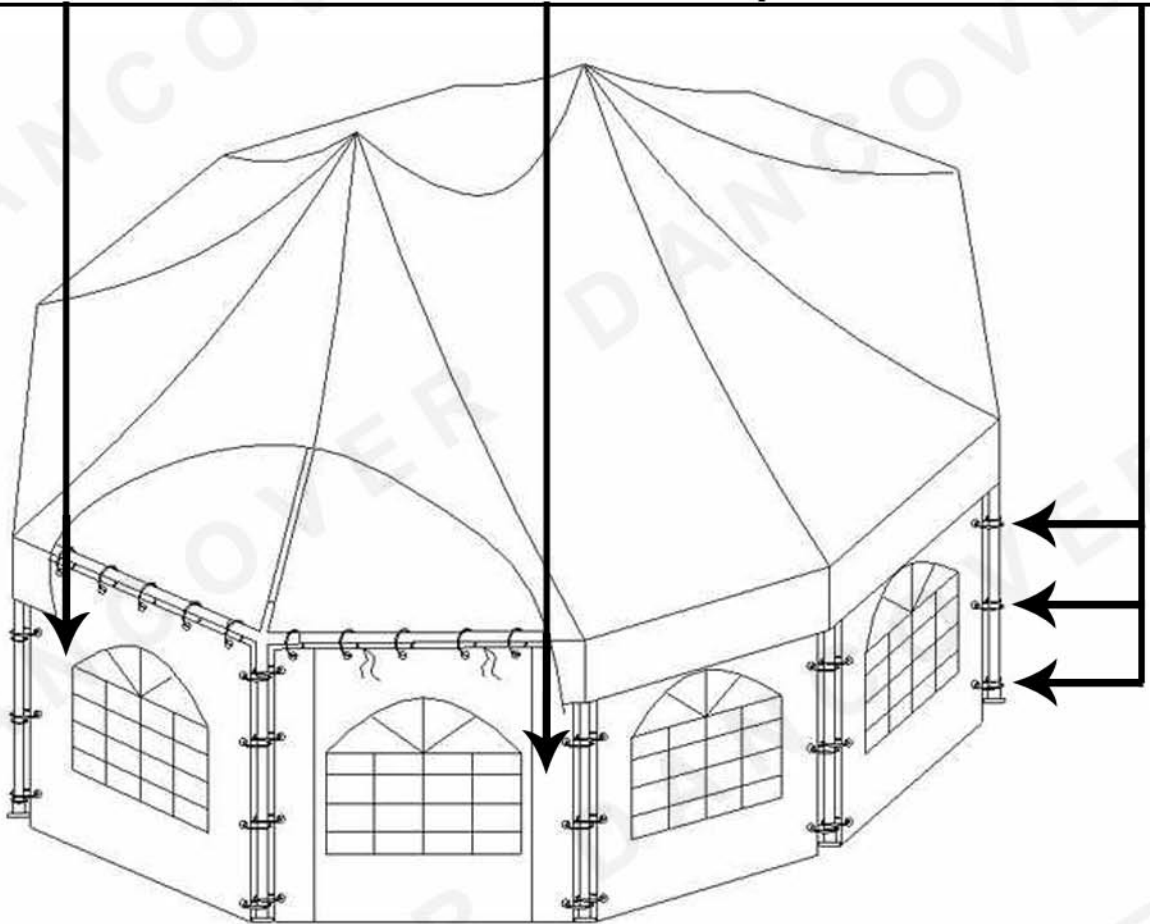
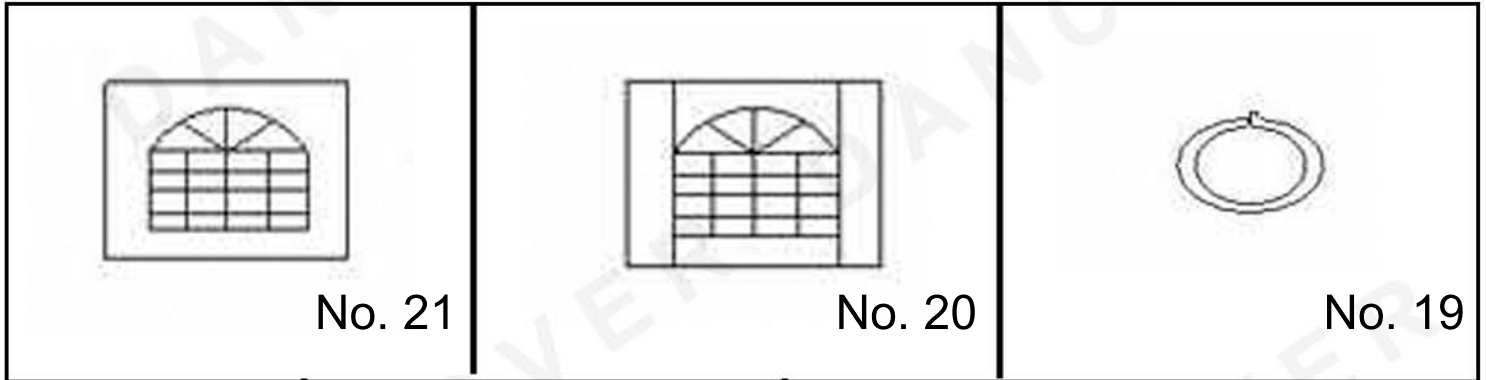

**Step 10:** Set up the wanted amount of sidewalls using the side-wall-rings (No. 19).

# Assembly

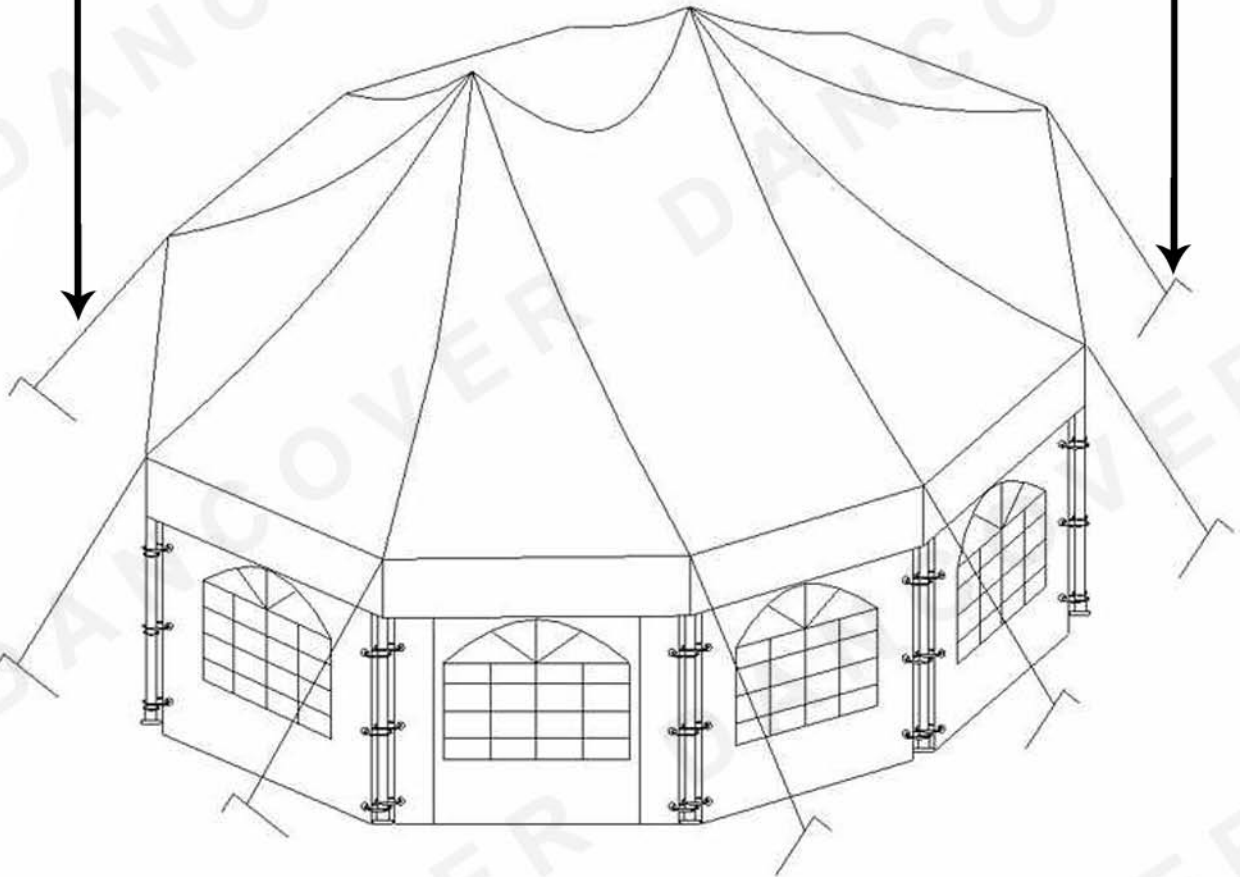
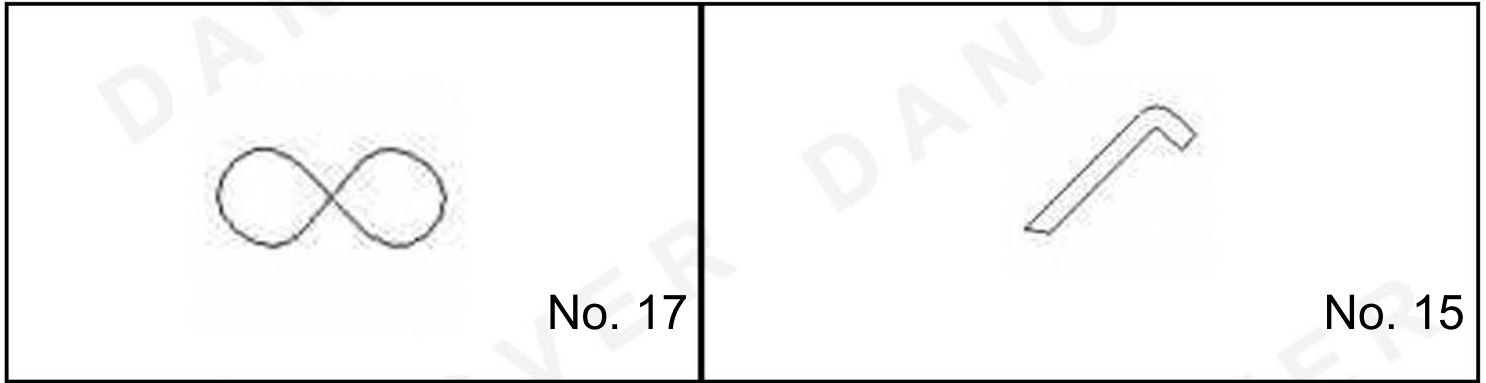

**Step 11:** Secure the tent with the guy lines (No. 17).

## Contact information

### Head office:

Dancover A/S  
Nordre Strandvej 119 G  
3150 Hellebæk  
Denmark

For more information  
please visit:  
[www.dancovershop.com](http://www.dancovershop.com)

## National contact

### Denmark:

[denmark@dancover.com](mailto:denmark@dancover.com)

### UK:

[uk@dancover.com](mailto:uk@dancover.com)

### Germany:

[germany@dancover.com](mailto:germany@dancover.com)

### France:

[france@dancover.com](mailto:france@dancover.com)

### Sweden:

[sverige@dancover.com](mailto:sverige@dancover.com)

### Finland:

[suomi@dancover.com](mailto:suomi@dancover.com)

### Poland:

[polska@dancover.com](mailto:polska@dancover.com)

### Luxembourg:

[luxembourg@dancover.com](mailto:luxembourg@dancover.com)

### Spain:

[espana@dancover.com](mailto:espana@dancover.com)

### Italy:

[italia@dancover.com](mailto:italia@dancover.com)

### Switzerland:

[schweiz@dancover.com](mailto:schweiz@dancover.com)

### Austria:

[austria@dancover.com](mailto:austria@dancover.com)

### Norway:

[norge@dancover.com](mailto:norge@dancover.com)

### Nederland:

[nederland@dancover.com](mailto:nederland@dancover.com)

### Ireland:

[ireland@dancover.com](mailto:ireland@dancover.com)

### Belgium:

[belgique@dancover.com](mailto:belgique@dancover.com)