

DANCOVER[®]



Manual for
Party tent
3m PE Series

DANCOVER[®]

.com

Safety Advice

Attention

In some countries approval is needed to set up a marquee/tent larger than 75 m². It is your responsibility to comply with local rules and regulations and to ensure that the marquee/tent is assembled correctly.

In case of bad weather conditions, it is your responsibility to ensure the marquee/tent is safely secured and that the marquee/tent does not cause damage to others.

Do not use open fire, welding equipment or other sources which can ignite, inside or close to the tent.

The marquee/tent must be safely secured. We recommend you secure your marquee/tent with straps and pegs as soon as it is assembled.

Make sure to check if the marquee/tent is covered by your home contents insurance.

Marquees/tents must be evacuated under extreme weather conditions.









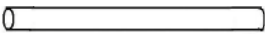

In the event of snow always remove snow from the roof of the marquee/tent regularly to prevent snow from building on the roof as heavy snow can cause the marquee/tent to collapse.

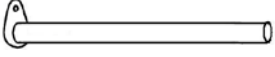
In the event of rain there is a risk of rain puddles building up on top of the roof of the marquee/tent. Heavy rain puddles can cause the roof to collapse. It is your responsibility to ensure rain puddles do not build up. As a precaution, make sure the roof of the marquee/tent is stretched out properly and adequately over the side frames of the marquee/tent and remove rain water regularly.

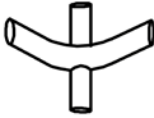
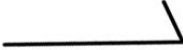
Note: Marquees are intended for events and other arrangements and are as such only meant for short term temporary assembly and the following disassembly. Dancover warranty applies only to the normal use of the Product, normal wear and tear excepted, in accordance with written use instructions or manual. The warranty does not apply to damage caused by accident, abuse, misuse, or modification of the Product.

Please always check our website for the latest safety advice and manual.

3m PE instruction

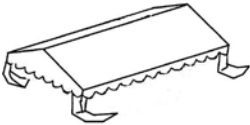
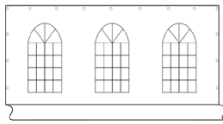
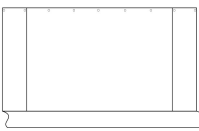
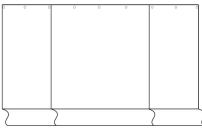
Part no.			3x4m	3x6m	3x8m	3x10m
1	Frame pole		6	8	10	12
2	Frame pole		6	9	12	15
3	Leg		6	8	10	12
4	3-way Connector		6	6	6	6
5	4-way Connector		3	6	9	12
6	Big peg		4	4	4	4
7	Middle peg		6	8	10	12
8	Small peg		23	27	31	35
9	Bungeeball long		52	60	68	76
10	Bungeeball short		14	14	14	14
11	Rope		4	4	4	4
12	O-Screw		30	42	54	66
13	Roof		1	1	1	1
14	Sidewall		2	2	2	2
15	Endwall with large door		1	1	1	1
16	Endwall with small door		1	1	1	1

Assemble instruction

Step 1

Select a flat ground for the tent, unpack the carton and check all the parts including tubes, tent and accessories... etc. are present same as list. Assemble the framework of rooftop by joining the portion (4.5) together with poles (1.2). To ensure the screw fixed to every pole tightly.

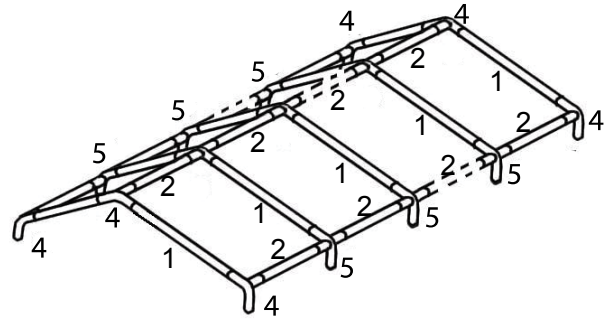

Step 2

Attach one end of the Leg (3) to the joints (4,5)

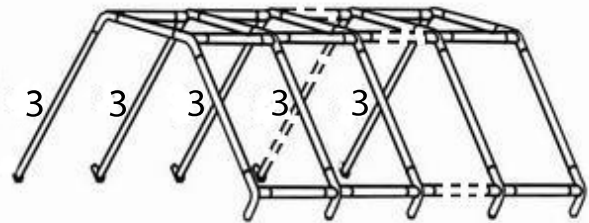

Step 3

Cover the roof on the frame and attach it with the bungee balls properly, take care of the tension of the bungee balls, for if you use too many on one side of the tent, it may become too tight to tie the other side of it.

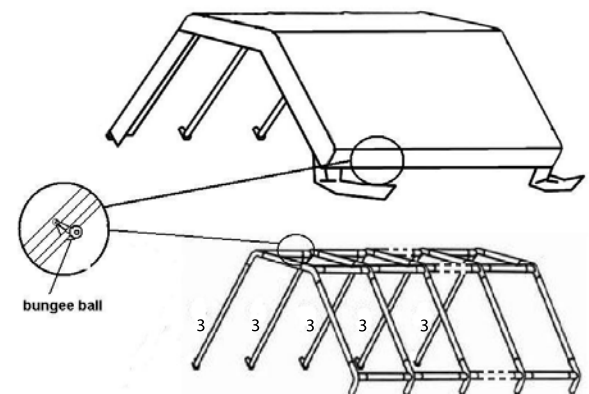

Step 4

Attach the remaining Legs (3) to the joints (4,5), to built-up the framework, use the long pegs to fix each pole into the ground.

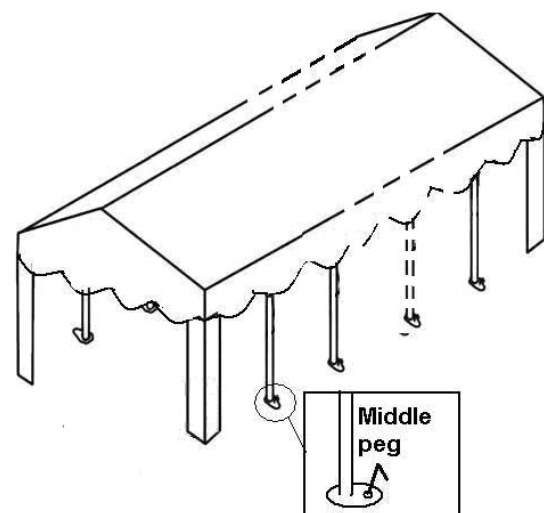

Assemble manual

Step 5

Fold out the sidewalls and the endwalls, attach to framework by using the bungeeballs locking the through the eyelets that are placed on top of the sidewalls and endwalls to ensure stability. Connect leg cover with sidewall by Velcro. Also use the short pegs to fix the doors to the ground.

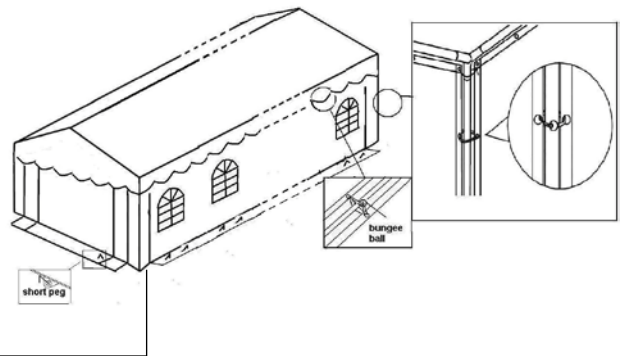
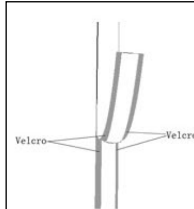

Step 6

Tie the rope to each corner of the tent. Tie the other end of the rope to a peg. Stick peg in ground.

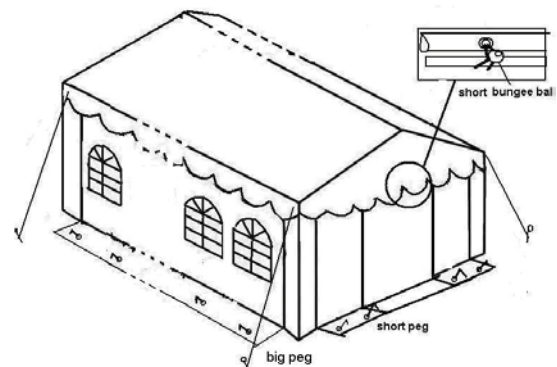

Warning:

1. In order to avoid rusting pipes, oil is covering the surface of the pipes, before erecting the tent, please remove the oil carefully first to keep the cover clean.
2. Take note that the tent needs to be handled carefully to avoid damage.
3. Do not force the frame as they may be damaged in the process.
4. Tents are meant as temporary shelter and must be evacuated under extreme weather conditions.
5. The windows maybe a little bit sticky to each other, when you unfold the windows, please do this as softly as you can. Or the windows might crack during the process.

Please select a suitable site for the tent to avoid the damage from underground sprinkler systems, water, gas or electrical lines.

Contact information

Head office:

Dancover A/S
Nordre Strandvej 119 G
3150 Hellebæk
Denmark

For more information
please visit:
www.dancovershop.com

National contact

Denmark:

denmark@dancover.com

UK:

uk@dancover.com

Germany:

germany@dancover.com

France:

france@dancover.com

Sweden:

sverige@dancover.com

Finland:

suomi@dancover.com

Poland:

polska@dancover.com

Luxembourg:

luxembourg@dancover.com

Spain:

espana@dancover.com

Italy:

italia@dancover.com

Switzerland:

schweiz@dancover.com

Austria:

austria@dancover.com

Norway:

norge@dancover.com

Nederland:

nederland@dancover.com

Ireland:

ireland@dancover.com

Belgium:

belgique@dancover.com