

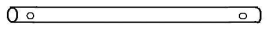

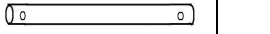









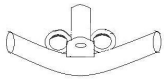
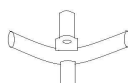
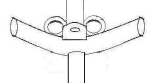
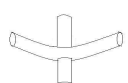

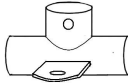
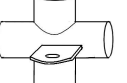

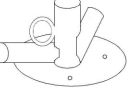
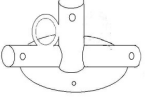
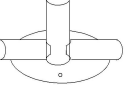
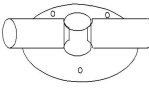





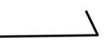

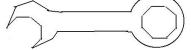



7x14m-2.3 PARTY TENT

													
1	16PCS	2	49PCS	3	32PCS	4	8PCS	5	16PCS	6	6PCS	7	4PCS
													
8	2PCS	9-1	4PCS	9-2	2PCS	10-1	8PCS	10-2	4PCS	11	4PCS	12	12PCS
													
13	2PCS	14	2PCS	15-1	4PCS	15-2	8PCS	16	4 pc	17	8PCS		
													
18	8PCS			Super peg	10pcs	Spiral peg	4pcs	Middle peg	20 pcs	Small peg	60 PCS	Allan key	1PC
													
Spencer	2PCS	Screw	32PCS	Nuts	32pcs	45mm screw	110pcs	60mm screw	96pcs	locknuts	210pcs		
													
Long bungeeball	300PCS	Short bungeeball	16PCS	Rope	4PCS	hook	16PCS	Roof	1 pcs	sidewall	14PCS	Endwall	2PCS

7x14m-2.3 PARTY TENT

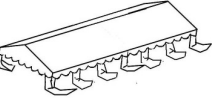
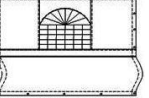
I

Select a flat ground for the tent, unpack the carton and check all the parts including tubes, tent and accessories... etc. are present as same as list.

Assemble the framework of rooftop by joining the portion (10.11.12.13.14.15.) together with poles (1.2.3). To ensure the screw fixed to every pole tightly

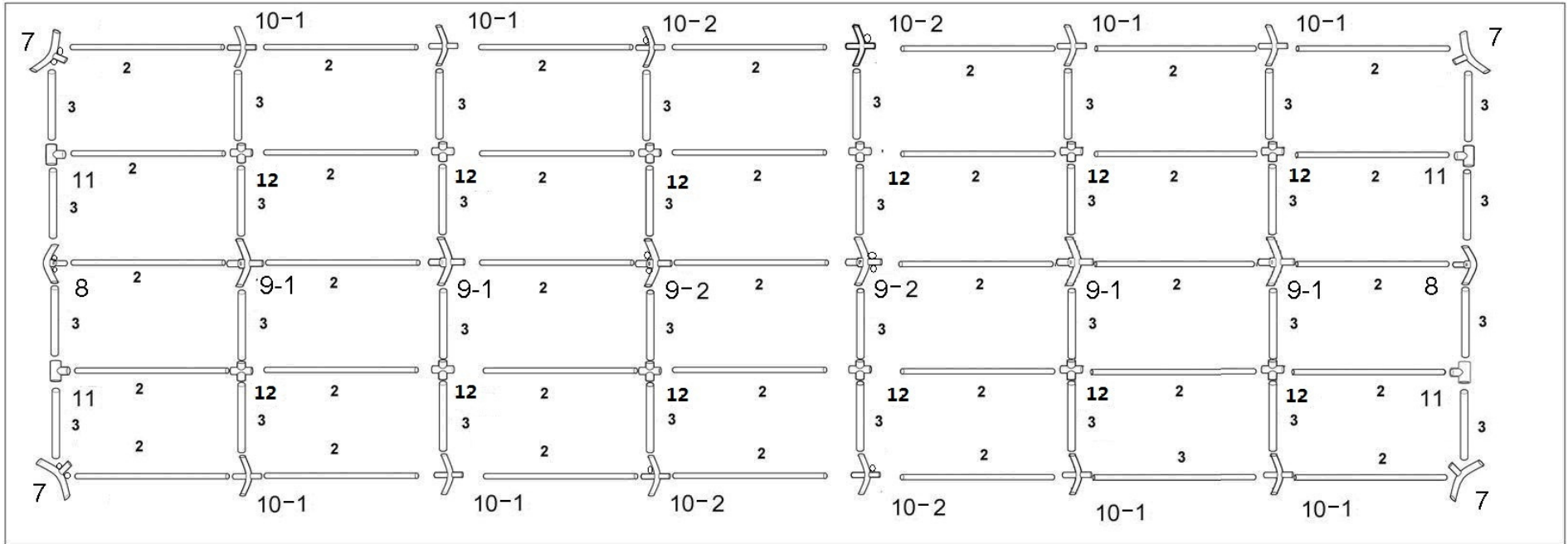

7x14m-2.3 PARTY TENT

II

Attach one end of supported pole (4.5) to the joints (7.8) ,Strengthen the frame by using screws and turnbuckle set (18 .) .Long screws are used on all connection between 50mm and 54mm pipe .Short screw are used on connection between 42mm and 38mm pipes .

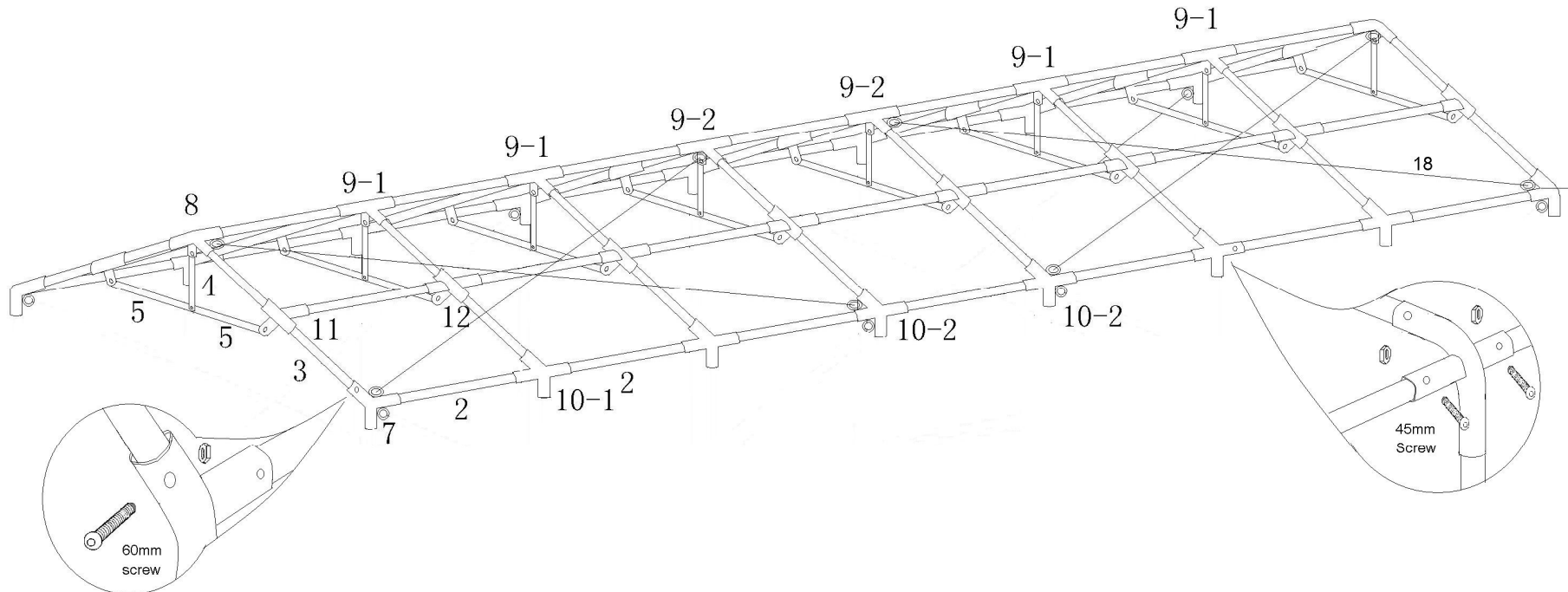

7x14m-2.3 PARTY TENT

III

Cover the roof on the frame ,and attach it by the bungee balls properly ,take care of the tension of the bungee balls ,for if you use too many on one side of tent ,it may too tight to tie the other side of it .Leg 8 which with a hold in the middle should be on two sides.

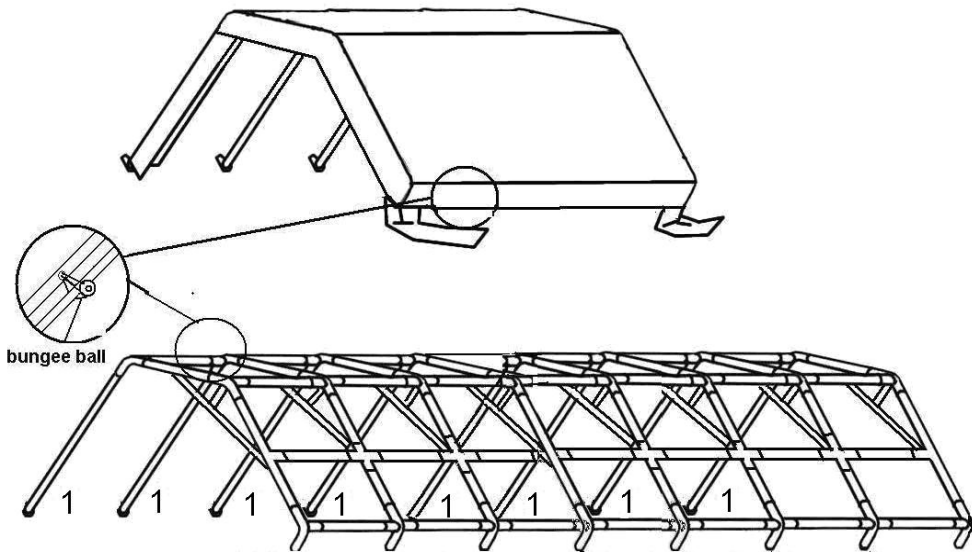

IV

Attach the another 7 supported poles (1) to the joints (7.10), built-up the framework ,use the long peg to fix each pole into the ground and use the hook to fix the leg cover to the leg .Tighten the frame by turnbuckle set 17.

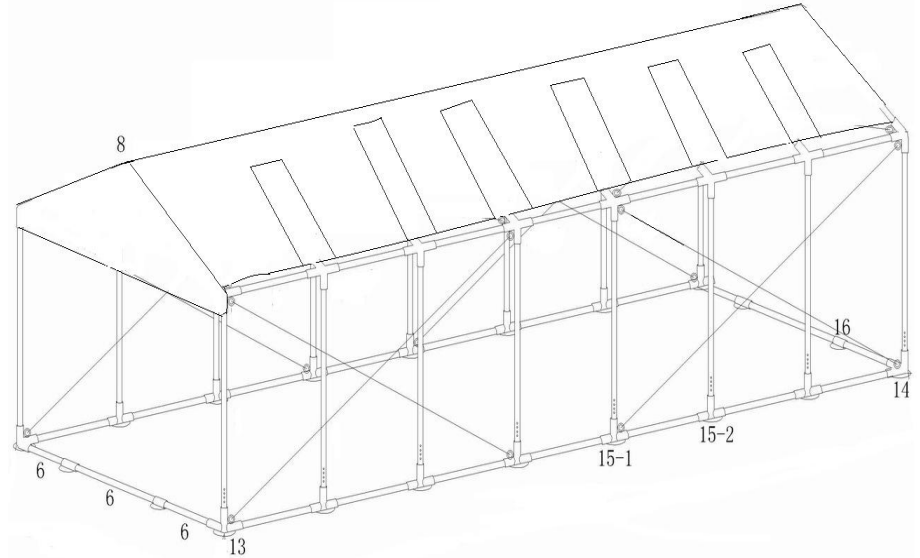

7x14m-2.3 PARTY TENT

V
spread the wall panel and door panel attach to framework by using the bungee cords clasp the frame to grommets that is construct over the wall panel and door panel to ensure stability. Also use the short pegs to fix the doors to the ground .

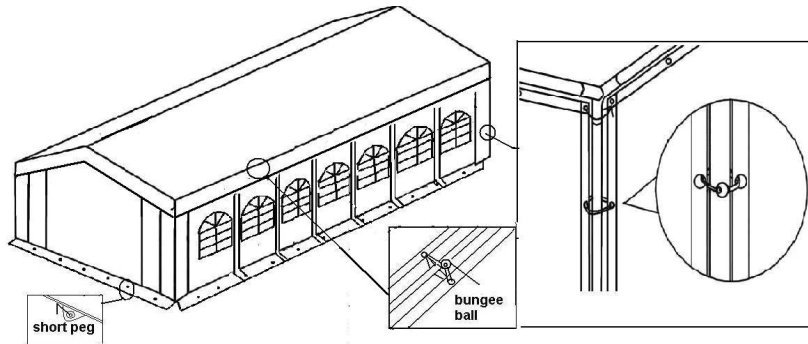

VI
The Guy lines clasp to each corner of tent and another end of line fix to ground by pegs.

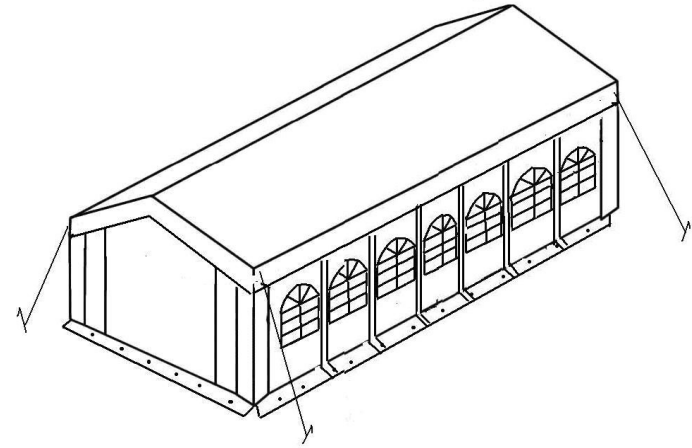

Warning

1. In order to avoid being rusted by air ,oil is covered on the surface of the pipes ,before set up the tent ,please remove the oil carefully frist to keep the cover clean.
2. Take note that the tent needs to be handled carefully to avoid damage.
3. Do not force the frame as they may be damage in the process.
4. Tents are meant as temporary shelter and must be evacuated under extreme weather conditions.

Please select a suitable site for the tent to avoid the damage to underground sprinkler systems, water, gas or electrical lines.