

**DANCOVER<sup>®</sup>** 

Party tent  
6 m PVC Series

# DANCOVER<sup>®</sup>

.com

## Safety Advice

### Attention

In some countries approval is needed to set up a tent larger than 75 m<sup>2</sup>.

The owner of the tent has the sole responsibility to make sure that these local rules are followed and that the mounting is correct.

In case of bad weather conditions, it is your responsibility to ensure that people inside are safe and that the tent does not cause damage to others.

Do not use open fire, welding equipment or other ignition sources in the tent. Though the fabric is made of flame retardant material it can still burn.











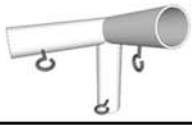

It is always recommended that you secure your tent properly with safety straps and augers when you put up the structure.

We recommend you to insure the tent, or check if it is covered by home contents insurance, in case of unplanned events, accidents or bad weather.

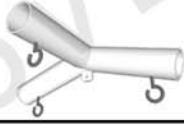

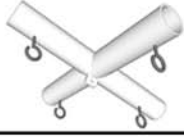







Tents are meant as temporary shelter and must be evacuated under extreme weather conditions.

This structure is not tested for specific snow and wind loads. That's why we always recommend to remove snow from the top.

# Part list.

Part No.	Part	6m	8m	10m	12m	14m
No. 01	 1470mm	16 PCS	20 PCS	24 PCS	28 PCS	32 PCS
No. 02	 1940mm	27 PCS	34 PCS	41 PCS	48 PCS	55 PCS
No. 03		8 PCS	10 PCS	12 PCS	14 PCS	16 PCS
No. 04		8 PCS	10 PCS	12 PCS	14 PCS	16 PCS
No. 05		4 PCS	5 PCS	6 PCS	7 PCS	8 PCS
No. 06		4 PCS	4 PCS	4 PCS	4 PCS	4 PCS
No. 07		4 PCS	6 PCS	8 PCS	10 PCS	12 PCS
No. 08		2 PCS	2 PCS	2 PCS	2 PCS	2 PCS
No. 09		2 PCS	3 PCS	4 PCS	5 PCS	6 PCS
No. 10		4 PCS	6 PCS	8 PCS	10 PCS	12 PCS
No. 11		4 PCS	4 PCS	4 PCS	4 PCS	4 PCS
No. 12		4 PCS	4 PCS	4 PCS	4 PCS	4 PCS
No. 13		4 PCS	6 PCS	8 PCS	10 PCS	12 PCS

# Part list.

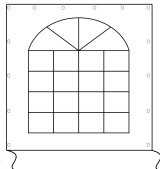
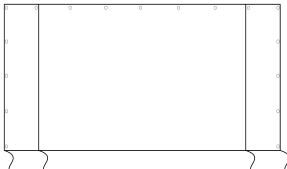
Part No.	Part	6m	8m	10m	12m	14m
No. 14		4 PCS	4 PCS	4 PCS	4 PCS	4 PCS
No. 15		4 PCS	4 PCS	4 PCS	4 PCS	4 PCS
No. 16		8 PCS	10 PCS	12 PCS	14 PCS	16 PCS
No. 17		36 PCS	42 PCS	48 PCS	54 PCS	60 PCS
No. 18		122 PCS	152 PCS	182 PCS	212 PCS	242 PCS
No. 19		16 PCS	20 PCS	24 PCS	28 PCS	32 PCS
No. 20		112PCS	132PCS	152 PCS	172PCS	192 PCS
No. 21		26 PCS	26 PCS	26 PCS	26 PCS	26 PCS
No. 22		4 PCS	4 PCS	4 PCS	4 PCS	4 PCS
No. 24		1 PCS	1 PCS	1 PCS	1 PCS	1 PCS
No. 25		6 PCS	8 PCS	10 PCS	12 PCS	14 PCS
No. 26		2 PCS	2 PCS	2 PCS	2 PCS	2 PCS

# Assembly

**Step 1:** Lay out all roof tubes and connectors as shown.

**Step 2:** Join the roof tubes and connectors from middle and out.

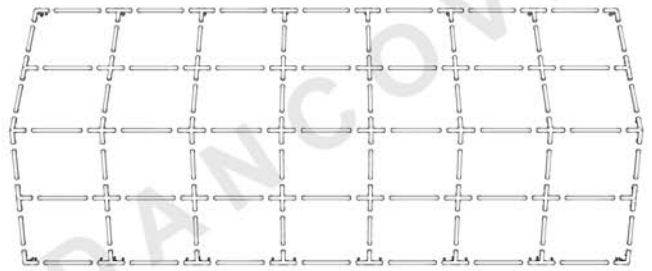

**Step 3:** Apply the gable safety bars as shown.

**Step 4:** Make sure all screws are tightened.

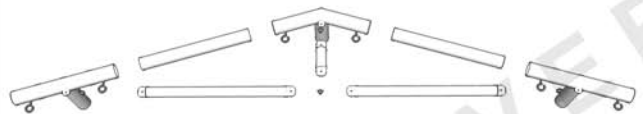

**Step 5:** Apply legs in one side as shown.

**Step 6:** Put the roof cover on and tie down with bungeeballs as shown.

\* Note, tie in the bungee-balls 5 at one side followed by 5 in the other and continue until finished

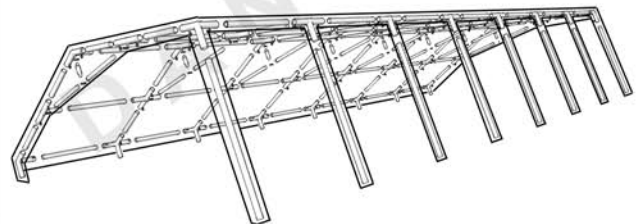

**Step 7:** Raise the legs in the opposite site.

**Step 8:** Make sure the cover is fastened.

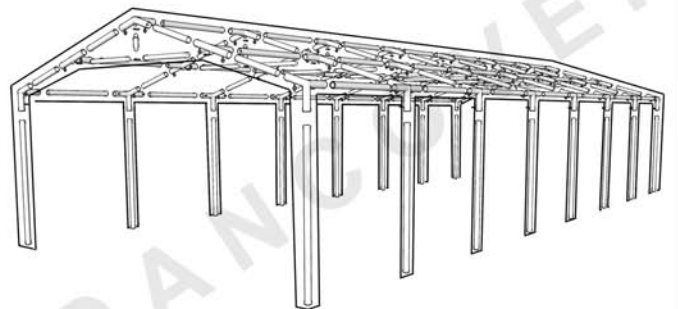

**Step 9:** Lay out the connectors and tubes of the Ground Bar.

**Step 10:** Assemble Ground Bar as shown.

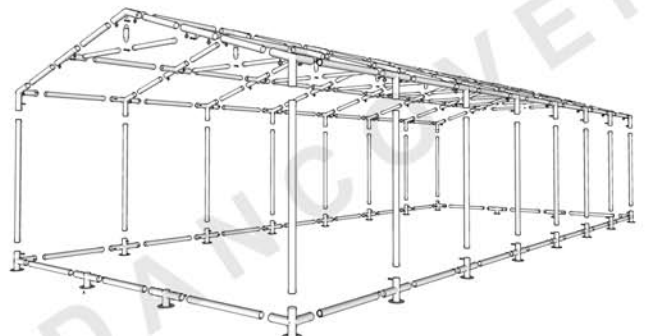

# Assembly

**Step 11:** Attach sidewalls with Bungee balls as shown.

**Step 12:** Connect leg cover with sidewall and endwall by velcro as shown

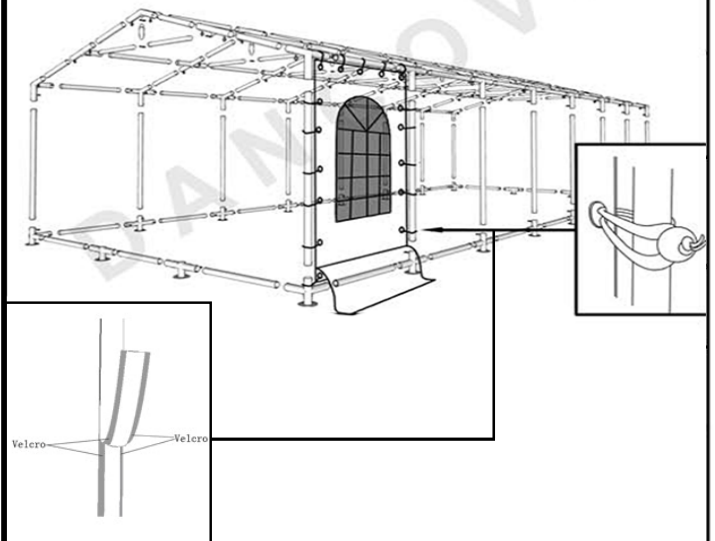

**Step 13:** Attach endwalls with Bungee balls as shown.

**Step 14:** Connect leg cover with sidewall and endwall by velcro as shown

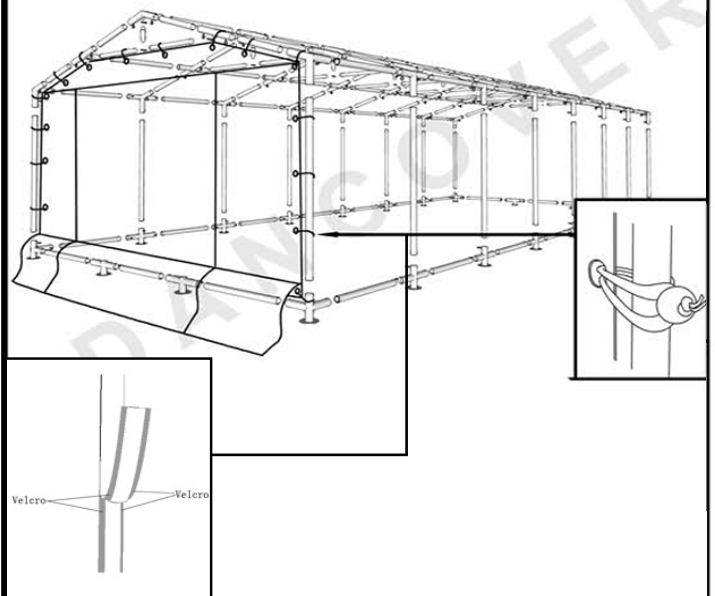

# Roof Assembly

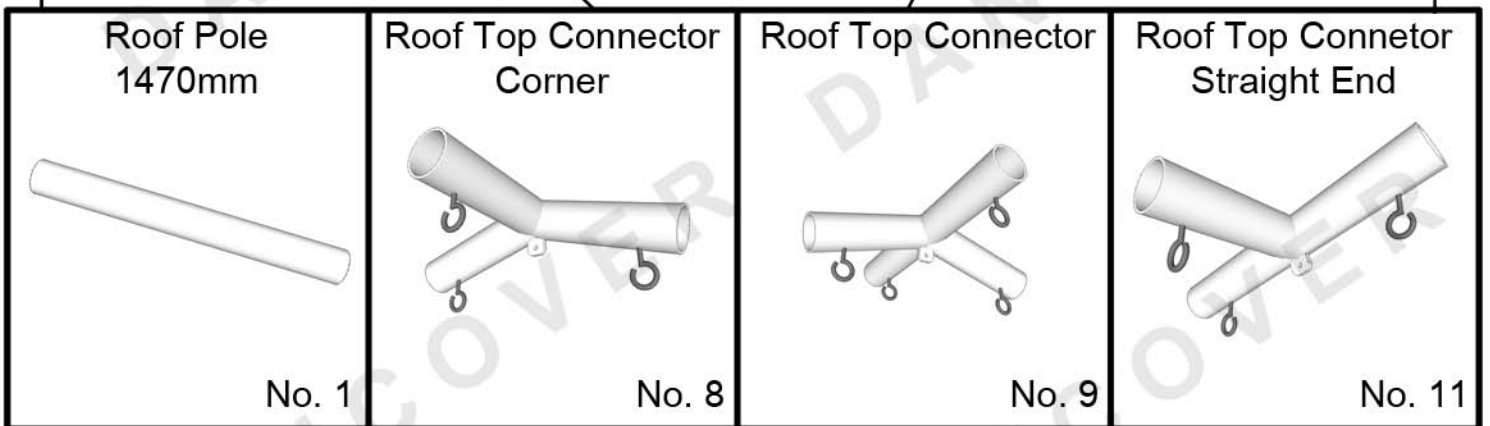
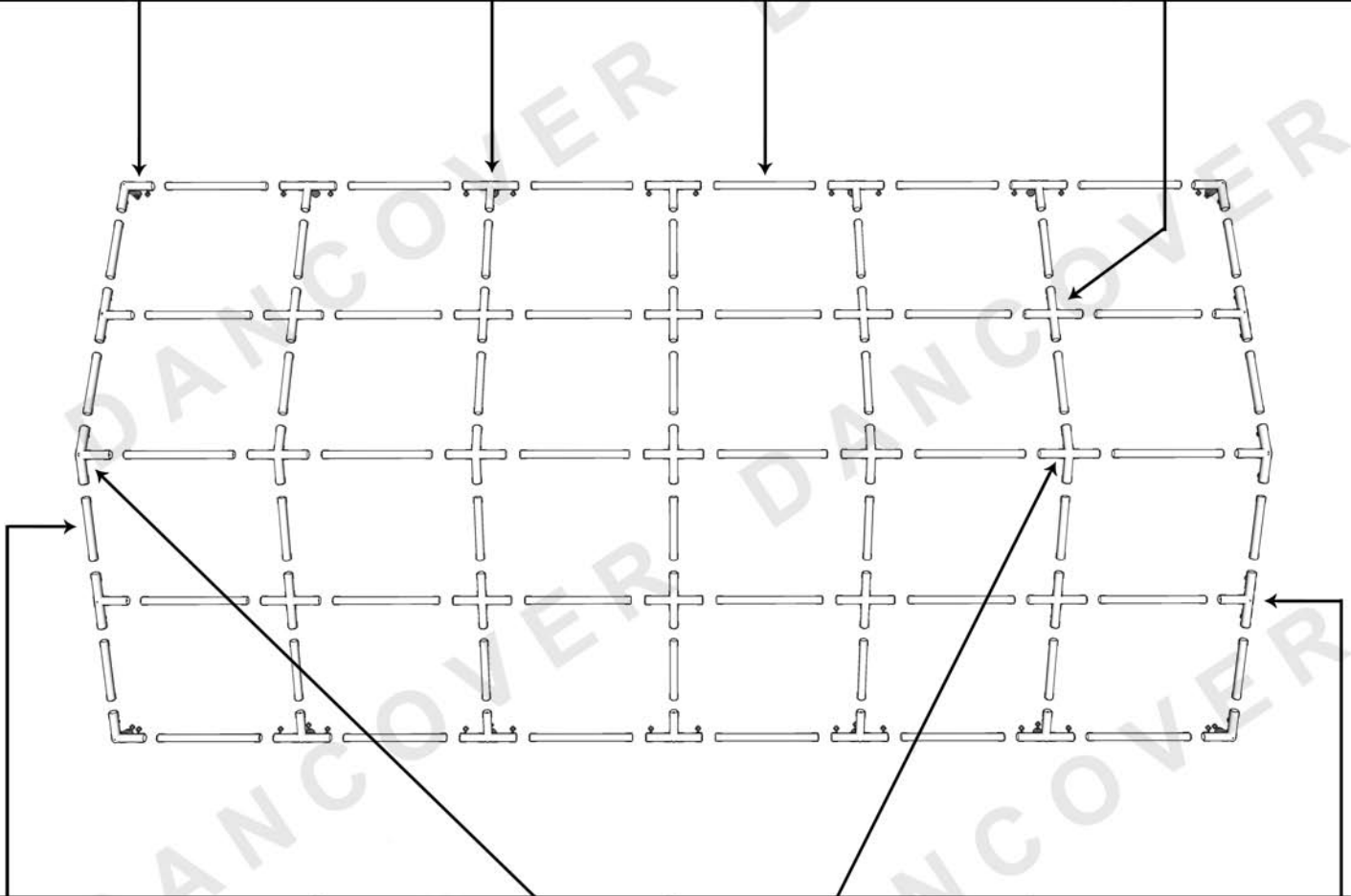
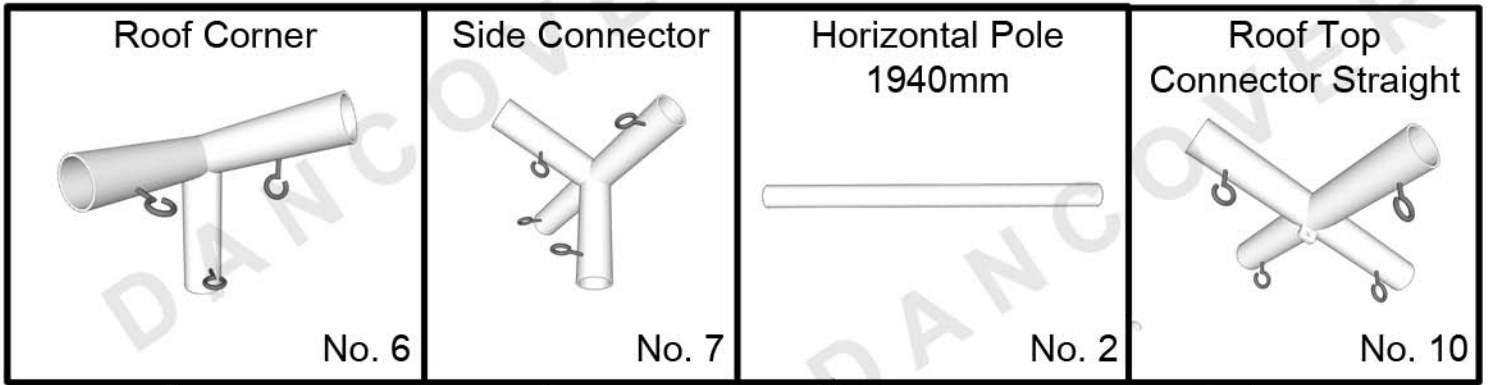

**Step 1:** Lay out all roof tubes and connectors as shown above.

**Step 2:** Join the roof tubes and connectors from middle and out.

**DANCOVER®**

# Gable Assembly

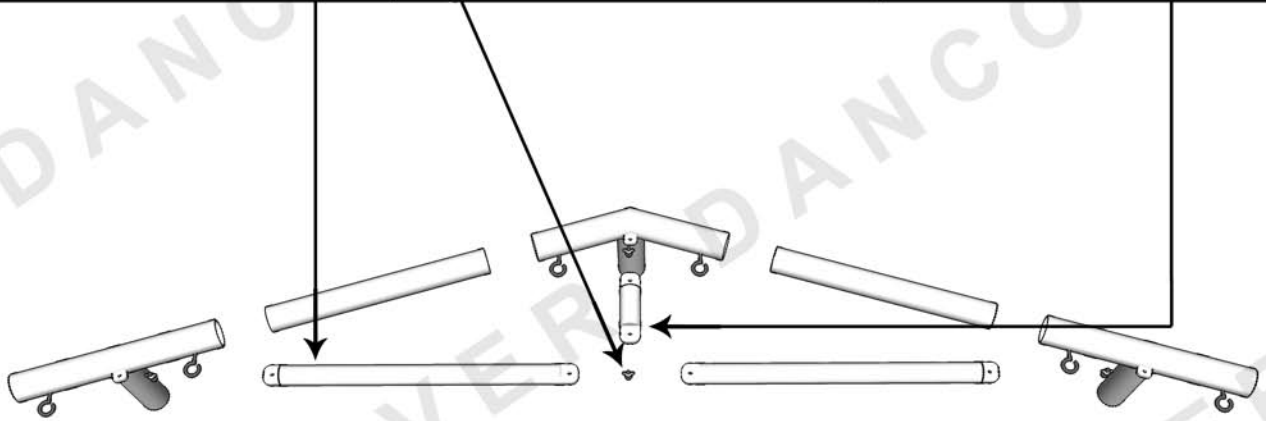
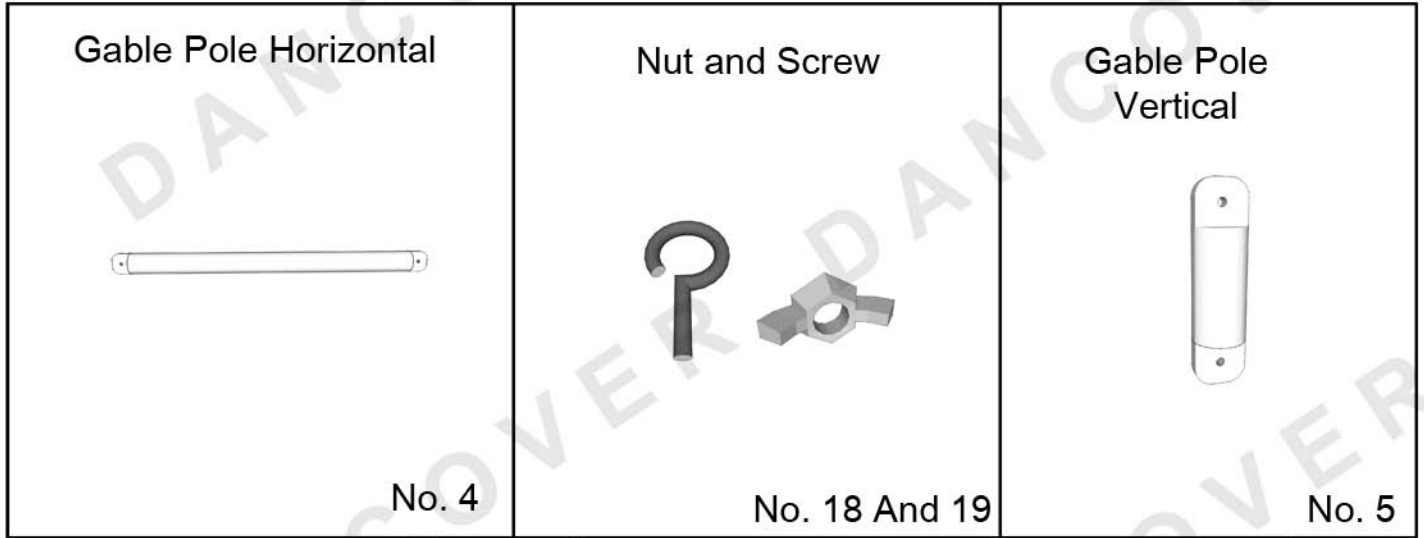

**Step 3:** Apply the gable safety bars as shown above.

**Step 4:** Make sure all screws are tightened.



# Ground Bar Assembly

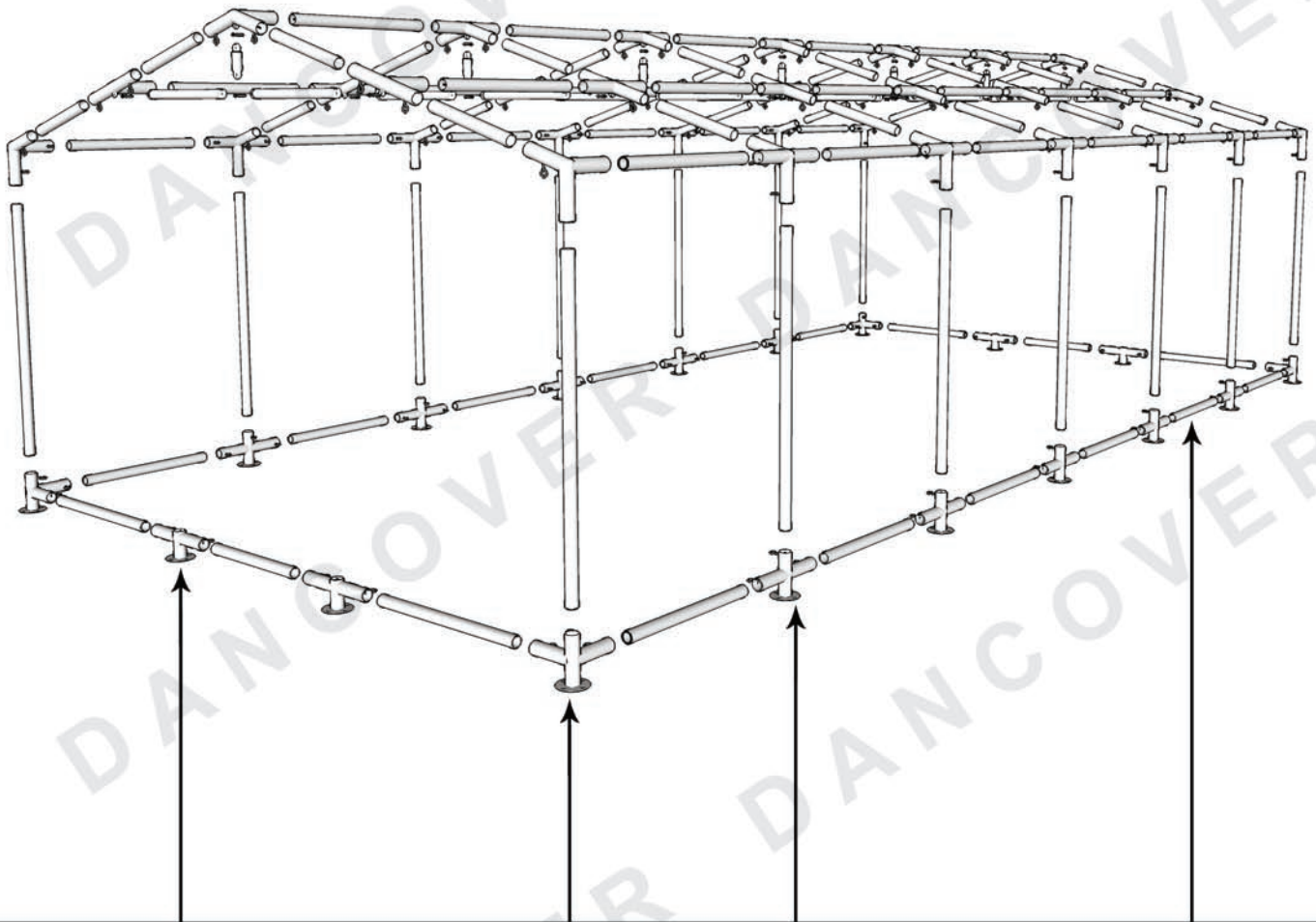

Ground Bar  
Connector End



No. 14

Ground Bar  
Connector Corner



No. 12

Ground Bar  
Connector Side



No. 13

Horizontal Pole  
1940mm



No. 2

**Step 9:** Lay out the connectors and tubes of the ground bar.

**Step 10:** Assemble ground bar as shown above.

## Contact information

### Head office:

Dancover A/S  
Nordre Strandvej 119 G  
3150 Hellebæk  
Denmark

For more information  
please visit:  
[www.dancovershop.com](http://www.dancovershop.com)

## National contact

Denmark:  
[denmark@dancover.com](mailto:denmark@dancover.com)

UK:  
[uk@dancover.com](mailto:uk@dancover.com)

Germany:  
[germany@dancover.com](mailto:germany@dancover.com)

France:  
[france@dancover.com](mailto:france@dancover.com)

Sweden:  
[sverige@dancover.com](mailto:sverige@dancover.com)

Finland:  
[suomi@dancover.com](mailto:suomi@dancover.com)

Poland:  
[polska@dancover.com](mailto:polska@dancover.com)

Luxembourg:  
[luxembourg@dancover.com](mailto:luxembourg@dancover.com)

Spain:  
[espana@dancover.com](mailto:espana@dancover.com)

Italy:  
[italia@dancover.com](mailto:italia@dancover.com)

Switzerland:  
[schweiz@dancover.com](mailto:schweiz@dancover.com)

Austria:  
[austria@dancover.com](mailto:austria@dancover.com)

Norway:  
[norge@dancover.com](mailto:norge@dancover.com)

Nederland:  
[nederland@dancover.com](mailto:nederland@dancover.com)

Ireland:  
[ireland@dancover.com](mailto:ireland@dancover.com)

Belgium:  
[belgique@dancover.com](mailto:belgique@dancover.com)