

**DANCOVER<sup>®</sup>**



PARTY TENT  
5m PE series

# DANCOVER<sup>®</sup>

.com

## Safety Advice

### Attention

In some countries approval is needed to set up a marquee/tent larger than 75 m<sup>2</sup>. It is your responsibility to comply with local rules and regulations and to ensure that the marquee/tent is assembled correctly.

In case of bad weather conditions, it is your responsibility to ensure the marquee/tent is safely secured and that the marquee/tent does not cause damage to others.

Do not use open fire, welding equipment or other sources which can ignite, inside or close to the tent.

The marquee/tent must be safely secured. We recommend you secure your marquee/tent with straps and pegs as soon as it is assembled.

Make sure to check if the marquee/tent is covered by your home contents insurance.











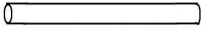
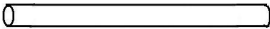

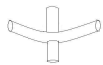

Marquees/tents must be evacuated under extreme weather conditions.

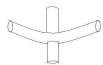
In the event of snow always remove snow from the roof of the marquee/tent regularly to prevent snow from building on the roof as heavy snow can cause the marquee/tent to collapse.

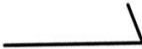
In the event of rain there is a risk of rain puddles building up on top of the roof of the marquee/tent. Heavy rain puddles can cause the roof to collapse. It is your responsibility to ensure rain puddles do not build up. As a precaution, make sure the roof of the marquee/tent is stretched out properly and adequately over the side frames of the marquee/tent and remove rain water regularly.

**Note:** Marquees are intended for events and other arrangements and are as such only meant for short term temporary assembly and the following disassembly. Dancover warranty applies only to the normal use of the Product, normal wear and tear excepted, in accordance with written use instructions or manual. The warranty does not apply to damage caused by accident, abuse, misuse, or modification of the Product.

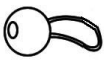
*Please always check our website for the latest safety advice and manual.*

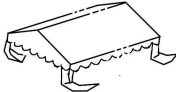
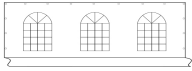
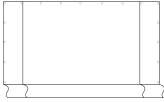
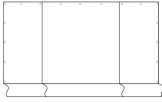
5m PE series Instruction						
Part no.			5x6m	5x8m	5x10m	5X12M
1	Frame pole		8	10	12	14
2	Frame pole		17	22	27	32
4	Leg		8	10	12	14
5	2-way connector		8	10	12	14
6	110° 3-way Connector		4	4	4	4
7	110° 4-way Connector		4	6	8	10
8	140° 3-way Connector		2	2	2	2
9	140° 4-way Connector		2	3	4	5
10	Spiral peg		4	4	4	4
11	Middle peg		8	10	12	14
12	Small peg		32	36	40	44
13	Screw		58	74	90	106
14	Bungeeball long		70	78	86	94
15	Bungeeball short		22	22	22	22
16	Rope		4	4	4	4
18	Roof		1	1	1	1
19	Sidewall		2	2	2	2
20	Endwall Large door		1	1	1	1
21	Endwall Small door		1	1	1	1

# Assemble Manual

## Step 1

Select a flat ground for the tent, unpack the carton and check all the parts including tubes, tent and accessories... etc. are present as same as list.

Assemble the framework of rooftop by joining the portion (5.6.7.8.9.) together with poles (1.2.4).

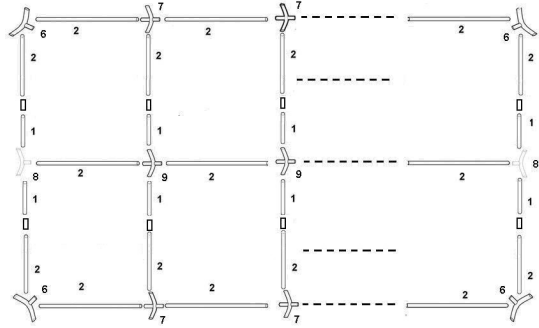

## Step 2

Attach one end of supported pole (4) to the joints (6.7)

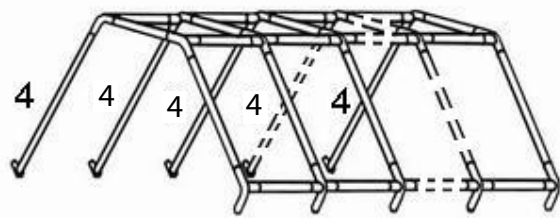

## Step 3

Cover the roof on the frame ,and attach it by the bungee balls properly ,take care of the tension of the bungee balls ,for if you use too many on one side of tent ,it may too tight to tie the other side.

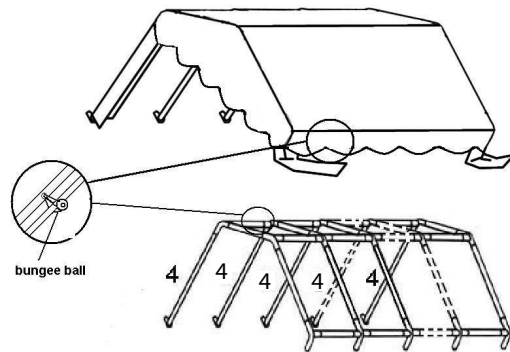

## Step 4

Attach the other supported poles to the joints , built-up the framework ,use the long peg to fix each pole into the ground and attach the leg cover to the sidewall by velcro.

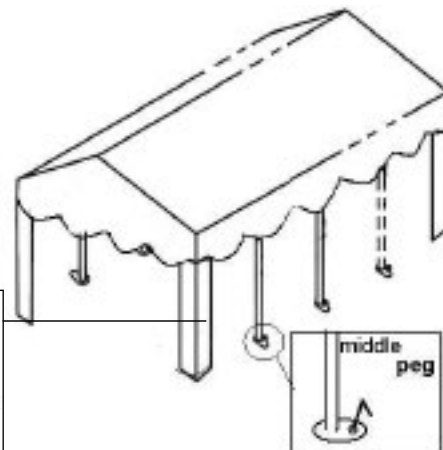
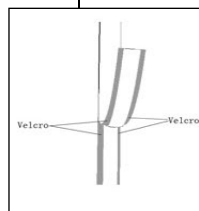

## Assemble Manual

### Step 5

Spread the wall panel and door panel. Attach to framework by using the bungee cords clasping the frame to grommets in wall panel and door panel to ensure stability. Use the short pegs to fix the doors to the ground .

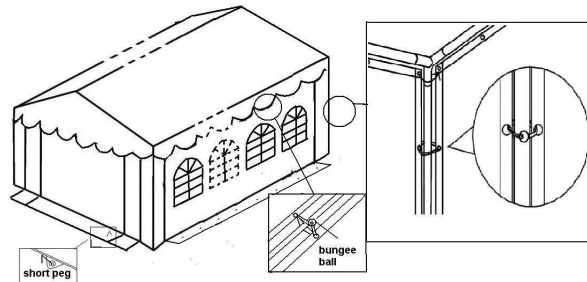

### Step 6

Clasp the guy lines to each corner of the tent. Fix the other end of the line to the ground with spiral pegs

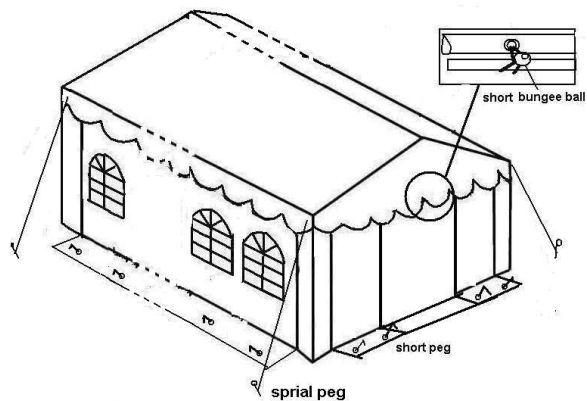

### Warning:

1. In order to avoid rust on the pipes, oil is covered on the surface. Before you set up the tent, please remove the oil carefully to keep the cover clean.
2. Take note that the tent needs to be handled carefully to avoid damage.
3. Do not force the frame as it may be damaged in the process.
4. Tents are meant as temporary shelter and must be evacuated under extreme weather conditions.
5. The windows may stick to each other, when you unfold it. Please do as softly as you can, or the windows may crack during the process.

Please select a suitable site for the tent to avoid damage to underground sprinkler systems, water, gas or electrical lines.

## Contact information

### Head office:

Dancover A/S  
Nordre Strandvej 119 G  
3150 Hellebæk  
Denmark

For more information  
please visit:  
[www.dancovershop.com](http://www.dancovershop.com)

## National contact

### Denmark:

[denmark@dancover.com](mailto:denmark@dancover.com)

### UK:

[uk@dancover.com](mailto:uk@dancover.com)

### Germany:

[germany@dancover.com](mailto:germany@dancover.com)

### France:

[france@dancover.com](mailto:france@dancover.com)

### Sweden:

[sverige@dancover.com](mailto:sverige@dancover.com)

### Finland:

[suomi@dancover.com](mailto:suomi@dancover.com)

### Poland:

[polska@dancover.com](mailto:polska@dancover.com)

### Luxembourg:

[luxembourg@dancover.com](mailto:luxembourg@dancover.com)

### Spain:

[espana@dancover.com](mailto:espana@dancover.com)

### Italy:

[italia@dancover.com](mailto:italia@dancover.com)

### Switzerland:

[schweiz@dancover.com](mailto:schweiz@dancover.com)

### Austria:

[austria@dancover.com](mailto:austria@dancover.com)

### Norway:

[norge@dancover.com](mailto:norge@dancover.com)

### Nederland:

[nederland@dancover.com](mailto:nederland@dancover.com)

### Ireland:

[ireland@dancover.com](mailto:ireland@dancover.com)

### Belgium:

[belgique@dancover.com](mailto:belgique@dancover.com)