

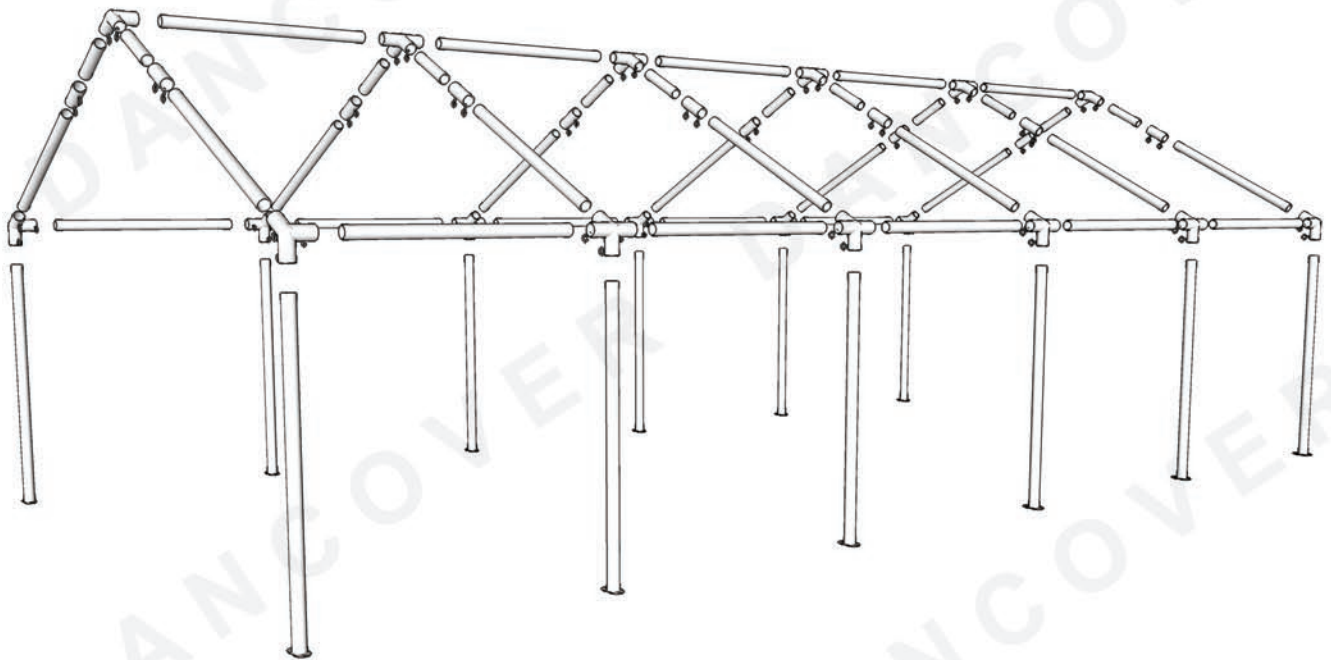













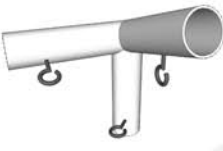





5x10m PE Marquee Assembly Guide



DANCOVER®

Part List

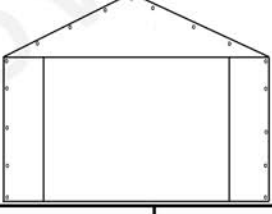
| | | | | | | | |
|---|-------|---|-------|--|-------|---|-------|
|  | |  | |  | |  | |
| 1 | 12pcs | 2 | 27pcs | 3 | 8pcs | 4 | 4pcs |
|  | |  | |  | |  | |
| 5 | 12pcs | 6 | 4pcs | 7 | 8pcs | 8 | 2pcs |
|  | |  | |  | |  | |
| 9 | 4pcs | 10 | 4pcs | 11 | 12pcs | 12 | 40pcs |
|  | |  | |  | |  | |
| 13 | 90pcs | 14 | 92pcs | 15 | 22pcs | 16 | 4pcs |
|  | |  | |  | |  | |
| 17 | 4pcs | 18 | 1pcs | 19 | 2pcs | 20 | 2pcs |
| | | | | | | | |
| | | | | | | | |
| | | | | | | | |
| | | | | | | DANCOVER® | |



Warning!:

1. To avoid rust you may experience oil on the poles, please remember to remove oil to keep the cover clean.
2. Do not force any of the parts together or the frame into place as it may be damaged.
3. Tents are meant as temporary shelters and must be evacuated under extreme weather conditions.
4. If tent is set up in an environment with a temperature below 0 degrees celsius, take ekstra care when handling the sides with windows to avoid breaking these. Unfold Sides under heated conditions to avoid breaking the window

Roof Assembly

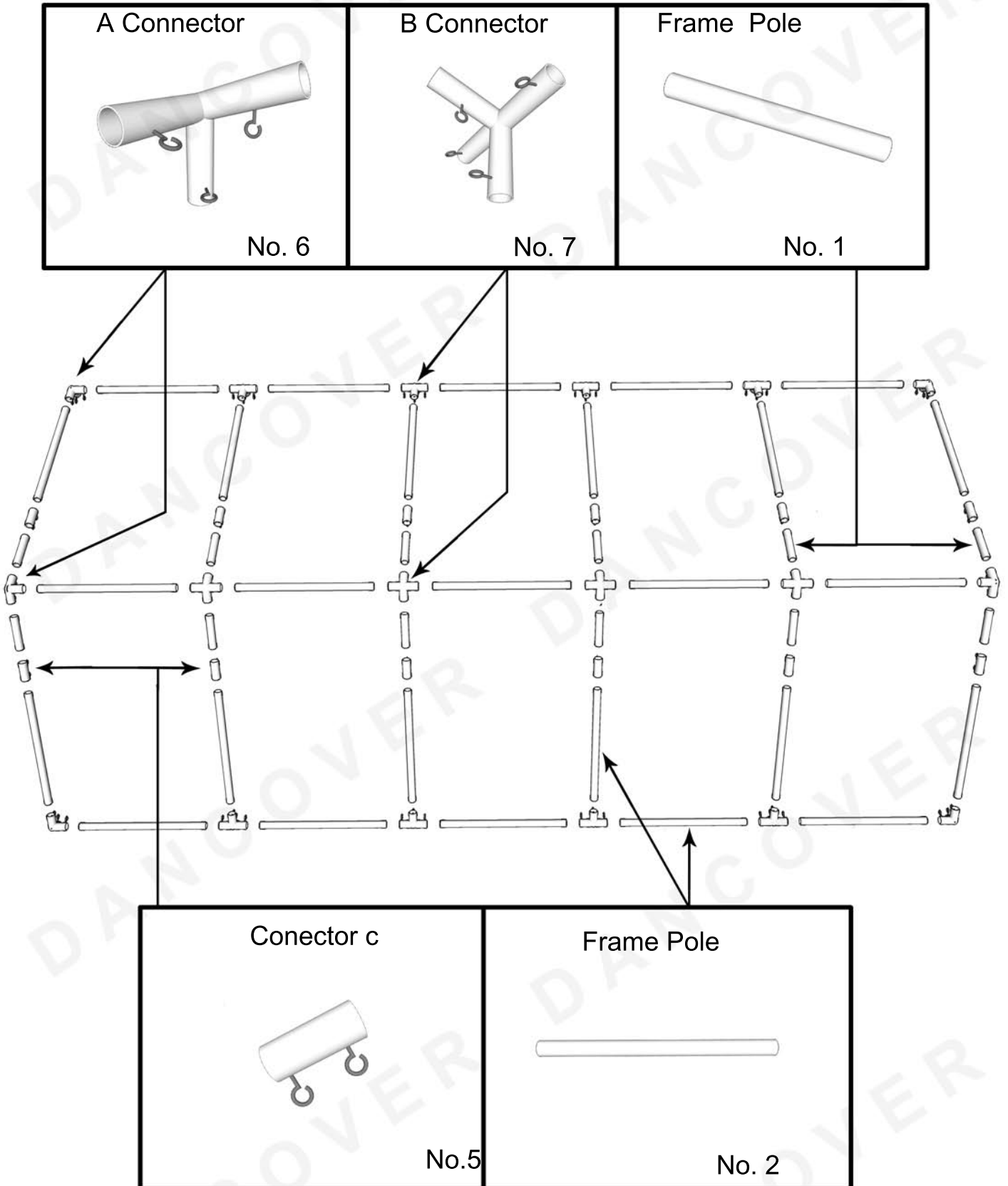

- Step 1:** Lay out all roof tubes and connectors as shown above.
Step 2: Join the roof tubes and connectors from middle and out.

Standing Leg Assembly

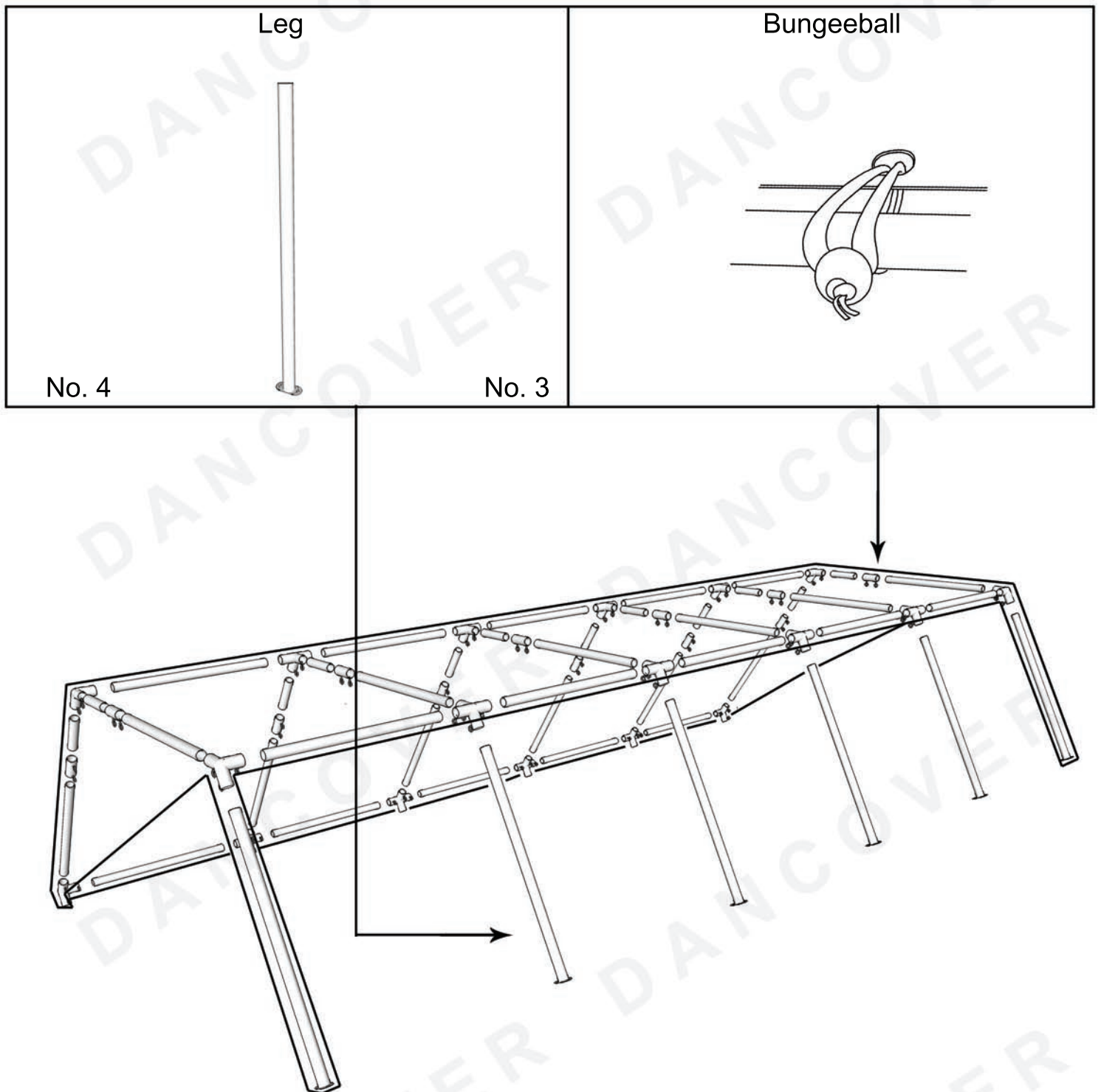

Step 5: Apply legs in one side as shown above (use no.4 in corner).

Step 6: Put the roof cover on and tie down with bungeeballs as shown.

* *Note, tie in the bungee-balls 5 at one side followed by 5 in the other and continue until finished*

Standing Leg Assembly

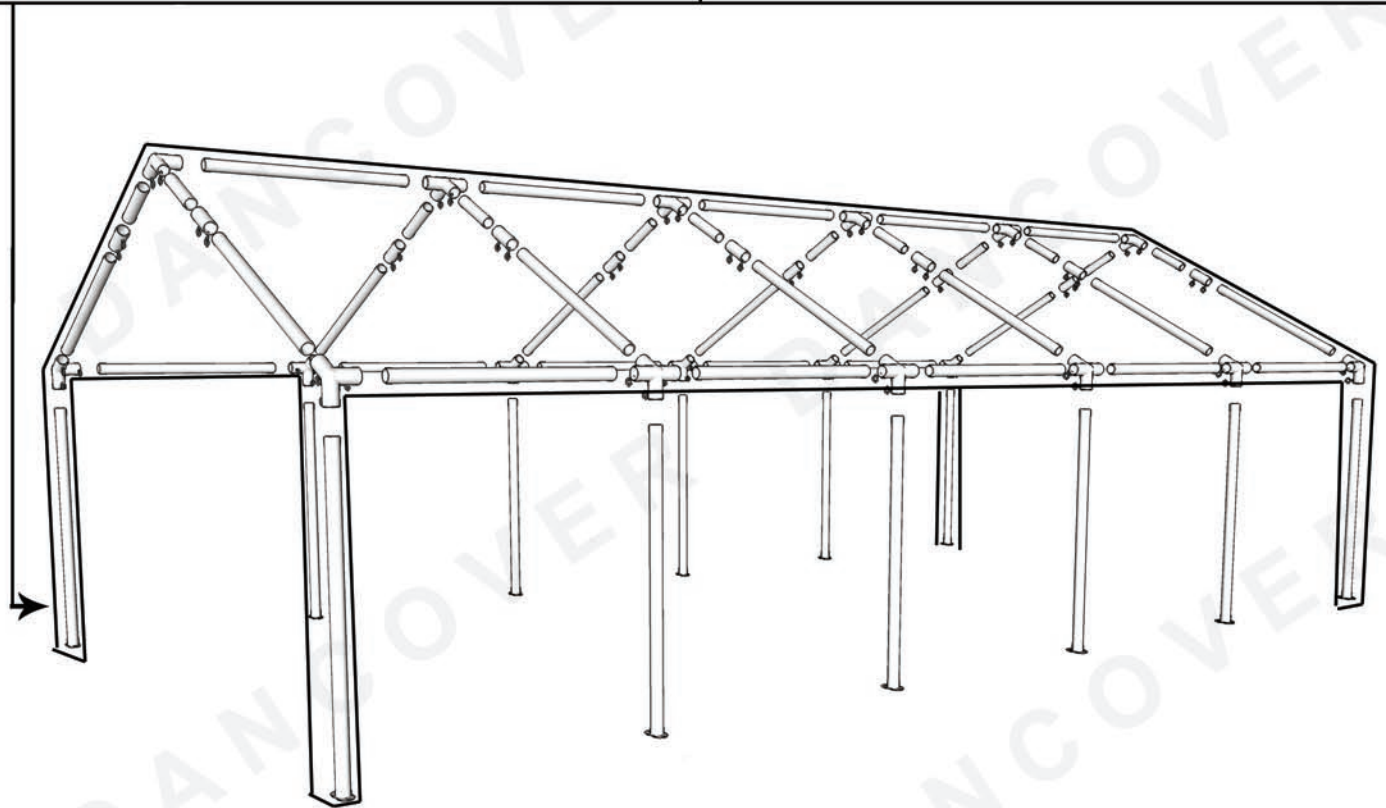
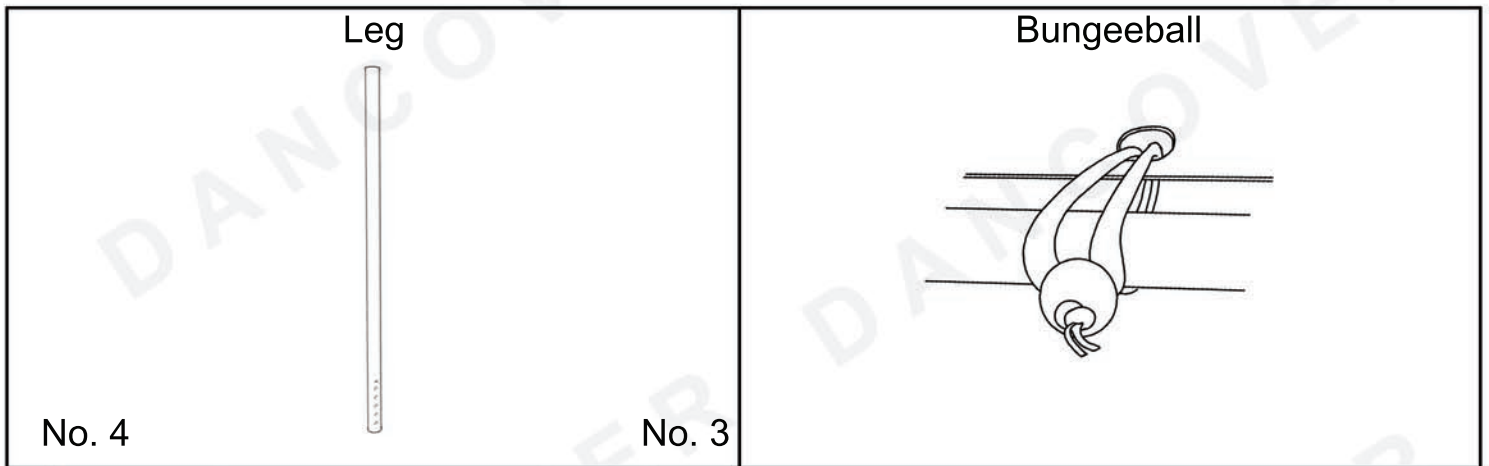

Step 7: Raise the legs in the opposite site (use no. 4 in corner).

Step 8: Make sure the cover is fastened.

Sidewall Assembly

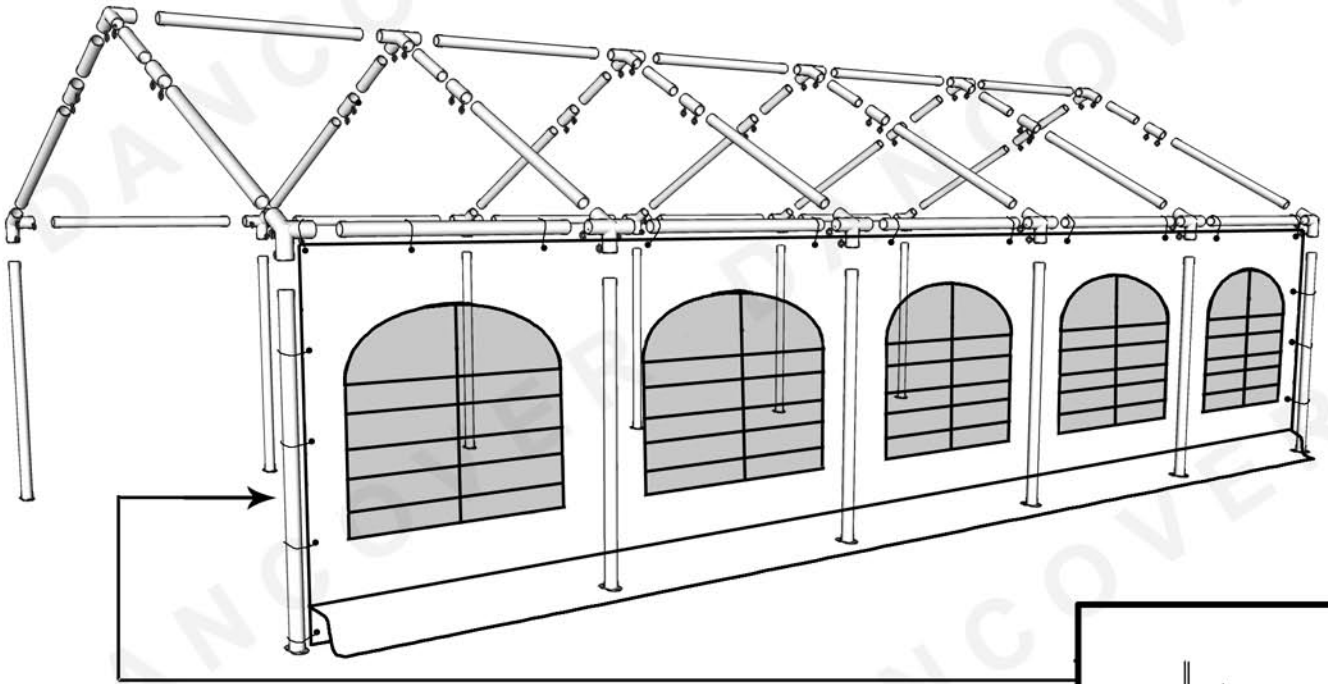

Step 11: Attach sidewalls with Bungeeballs as shown above.

Step 12: Attach endwalls with Bungeeballs as shown below.

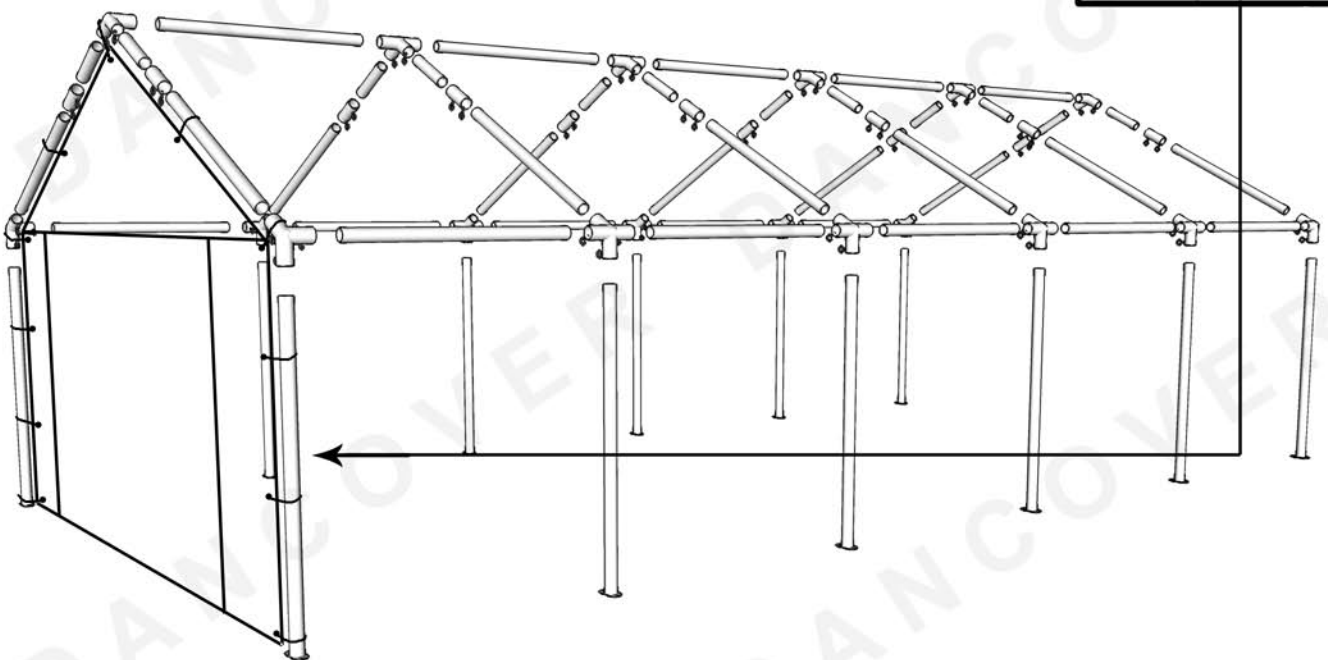
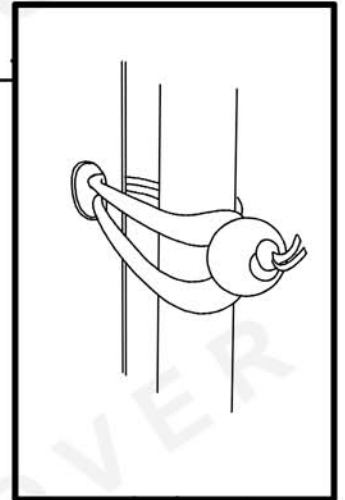

DANCOVER®

Contact Information

Head office:

Dancover A/S
Nordre Strandvej 119 G
3150 Hellebæk
Danmark

National Contact:

Denmark:
mail@dancover.dk
70267620

Spain:
Espana@dancover.com
902 906 098

UK:
Mail@dancover.co.uk
020 7221 0220

Italy:
italia@dancover.com
02 303 75317

Germany:
mail@dancover.de
041 0266 7040

Switzerland:
schweitz@dancover.com
0840000125

France:
france@dancover.com
0810 000 219

Austria:
austria@dancover.com
0662 626 935

Sweden:
mail@dancover.se
040 233 262

Norway:
mail@dancover.dk
231 00 690