

**DANCOVER<sup>®</sup>**

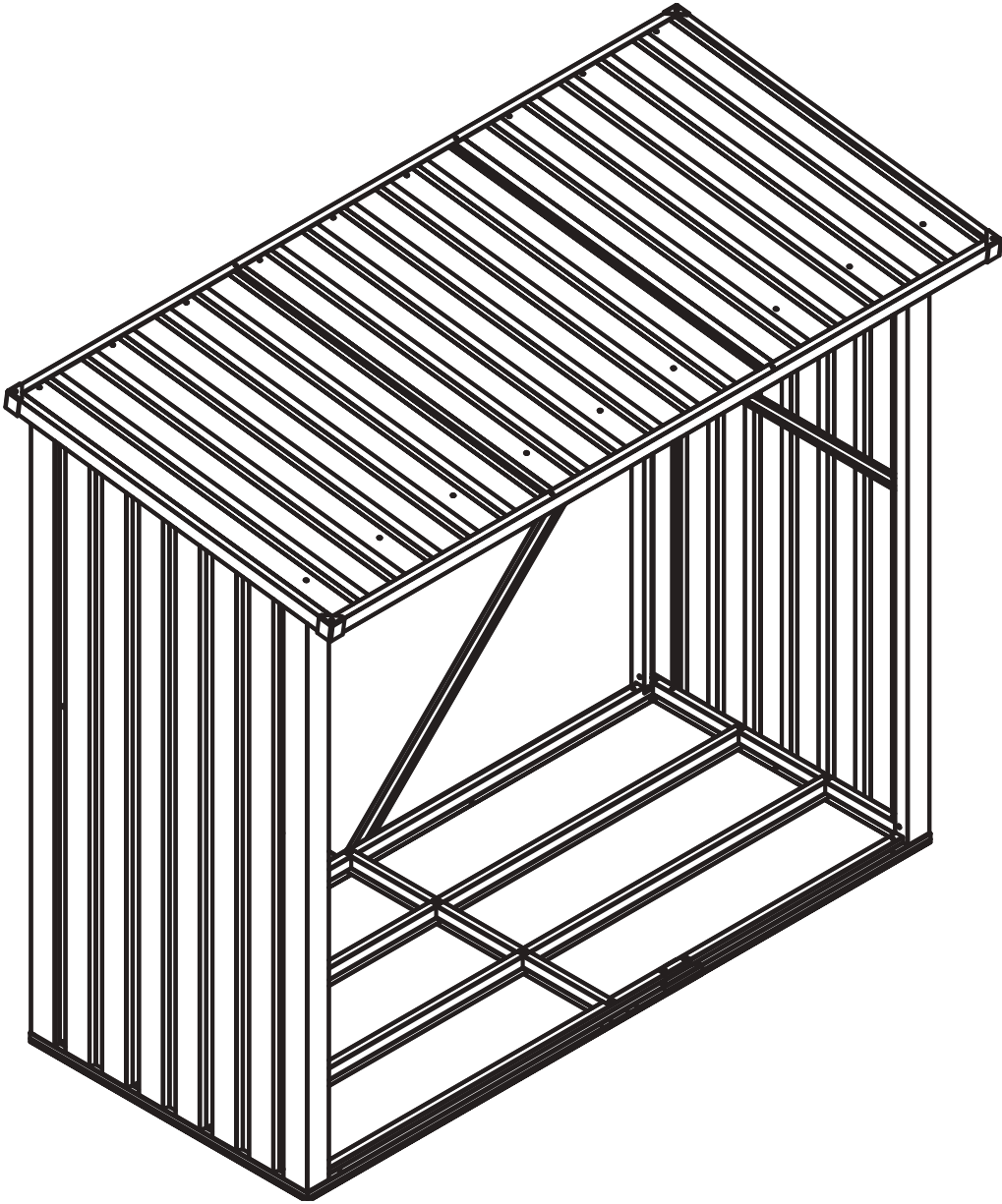

Manual  
for  
Wood Storage  
1,82x0,89x1,56cm

# Wood Storage



---

Requires two people for Installation.

# Assembly Preparation

## Owner's Manual

Please check local building codes regarding footings, location and other requirements before beginning construction. Study and understand this owner's manual of important information and helpful tips for easier and more enjoyable assembly.

## Assembly instructions:

Reviewing all instructions and the appropriate information before you begin, make sure following the step sequence carefully for successful results.

## Flooring base:

Your storage building must be anchored to prevent wind damage and A base may necessary to be constructed with a square and level building. The base is not included in the kit which may need purchase separately or may construct a foundation and anchoring system of your own. A good location for the storage building is a level area with good drainage.

## Parts and Parts List:

Check to be sure that you have all the necessary parts for your building.

## Tools you need:

( Please tear off the safety protection layer before the assembly, keep the part number label if needed )

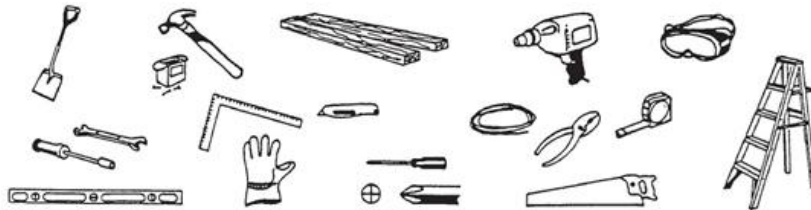

## Safety must be put in the No. 1 position:

- 1 Select a dry and calm day for your assembly. Team works ( Two or more people ) are required during the assembly;
- 2 Wearing safety gloves, eye protection and long sleeves during the assembly to prevent injury; Pay attention to the sharp edge of some parts;
- 3 Children and pets are not allowed entering into the construction site;
- 4 Never concentrate your total weight on the roof of the building. When using a step ladder make sure that it is safety;

## Care & Maintenance:

- 1 Keep the shed clean with soft cloth, use water if necessary;
- 2 Keep the door tracks clear of dirt and other stuff that prevent them from sliding easily.
- 3 Clean the snow with necessary tools to make sure it is safe to enter into.
- 4 The shed is not made for living but storing stuff.
- 5 Please add some oil on the top and bottom door sliding channel to make door slides smoothly.

# Manuel d'utilisateur

Merci de contrôler soigneusement ce qui concerne la fondation, le lieu et d' autres exigences avant de démarrer la construction ainsi que la loi de construction de la localité, veuillez étudier et comprendre les informations importantes et les précautions relatives dans ce manuel, pour que le montage soit plus facile, et vous allez découvrir le plaisir en même temps.

## Instructions d'installation:

Avant de commencer à l'installer, il vous faut être obligatoirement de bien lire ces instructions d'installation en respectant les étapes relatives à l'installer petit à petit, afin de l'achever favorablement.

## Options des lieux d'installation:

Il faut installer votre salle de stockage sur la fondation fixée. Il sera possible d'établir une installation de la fondation au carré avec une construction horizontale. Ce lieu doit protéger contre le vent, doit être sec et avoir un bon système de drainage. La fondation est hors de cette installation, vous pouvez l'acheter indépendamment ou la construire par vous-même.

## Liste d'éléments et d'accessoires:

Veillez bien vérifier et contrôler que les éléments dont vous avez besoin sont complets suivant la liste d'éléments (merci de supprimer le film de protection en plastique avant d'installer les pièces, si nécessaire, notez et gardez le numéro de l'étiquette) :

## Les instruments demandés (voir les images):

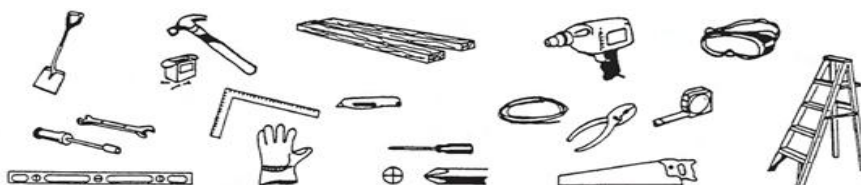

## Veillez faire attention à la sécurité lors d'utilisation des instruments.

### Consignes à observer:

- 1 Installez la salle de stockage dans un jour où il est sec et sans vent. Il faut avoir deux opérateurs ou plus qui travaillent en équipe afin de finir l'installation de cette salle de stockage;
- 2 Portez les gants de sécurité, les verres protecteurs et mettez des vêtements à manches longues pour l'installer, afin d'éviter la blessure, veuillez faire attention aux angles vifs de quelques éléments;
- 3 L'enfant et l'animal domestique sont interdits d'entrer aux sites de construction;
- 4 Il est interdit de concentrer le poids de corps sur le toit. Lors d'utilisation d'échelle pour monter haut ou quand vous utilisez d'autres instruments, il faut le manipuler correctement afin d'assurer sa sécurité;

### Maintenance et entretien:

- 1 Gardez les choses propres dans la salle de stockage interne et externe, essuyez cette salle par les chiffons doux, utilisez de l'eau pure si nécessaire;
- 2 Afin d'assurer la glissade favorable de la porte, veuillez garder la propreté des rails de porte, et débayer à temps le bastringue et les déchets des rails de porte.
- 3 Il faut débayer à temps l'enneigement, l'enneigement important causera l'empêchement. Vérifiez la sécurité avant d'y entrer;
- 4 Cette salle de stockage est seulement utilisée pour le stockage des objets, c'est interdit de l'utiliser comme une résidence ou d'autres fonctionnements.

# Manual del Usuario

Por favor revise cuidadosamente la fundación y la ubicación relacionadas y otros requisitos antes del inicio de las obras, así como los códigos de construcción locales, estudie y comprenda la información importante y precauciones relativas de las instrucciones presentes, con el fin de facilitar la instalación y disfrutar de la diversión.

## Instrucciones de instalación

Antes de iniciar la instalación, asegúrese de leer cuidadosamente las instrucciones y siga los pasos uno por uno para instalar, para terminar con éxito.

## Selección de la ubicación de instalación

Su cuarto de almacenamiento deberá ser instalado sobre la fundación fija. Cuando sea necesario pueden necesitar construir unas instalaciones en tierra de forma cuadrada y a nivel. El lugar debe ser a prueba de viento, seco y está provisto de un buen sistema de drenaje. La fundación no está incluida dentro del presente paquete, la cual puede ser adquirida por separado o construida a su propia cuenta.

## Lista de piezas y accesorios

Por favor verifique y revise la integridad de los componentes necesarios de acuerdo con la lista de partes (despegue la película protectora de plástico antes de ensamblar las piezas, y si es necesario, note y conserve el número de etiqueta):

## Herramientas necesarias (ver la figura):

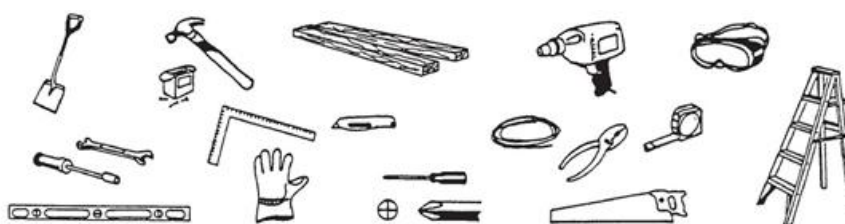

**Por favor preste atención a la seguridad al utilizar las herramientas.**

## Precauciones

- 1 Se realiza la instalación en días secos y sin viento. Se necesitan dos o más personas trabajando en equipo para completar la instalación de este cuarto de almacenamiento.
- 2 Use guantes de seguridad, gafas y ropa de manga larga para instalar con el fin de evitar daños; Tenga en cuenta de las agudas de algunas partes.
- 3 Se prohíbe la entrada de los niños y mascotas en el sitio de construcción.
- 4 Se prohíbe concentrar el peso del cuerpo en el techo. Cuando se utilicen la escalera u otras herramientas, asegúrese la operación correcta para garantizar su seguridad.

## Mantenimiento

- 1 mantenga limpio el interior y exterior del cuarto de almacenamiento y utilice el trapo suave para limpiar, o utilice el agua cuando sea necesario.
- 2 Para garantizar que la puerta pueda deslizarse suavemente, mantenga limpio el carril de la puerta y limpie a tiempo los residuos y basuras.
- 3 Debe limpiar sin demora la nieve, y la severa nieve puede causar derrumbe. Por favor preste atención a seguridad cuando entre.
- 4 El presente cuarto de almacenamiento está destinado solamente a almacenar objetos, y se prohíben la residencia u otros efectos.

# Bedienungsanleitung

Überprüfen Sie sorgfältig auf Fundament , Standort und andere Anforderungen vor dem Bau sowie örtliche Bauvorschriften , erforschen und verstehen Sie die wichtige Informationen und relevante Hinweisen von dieser Bedienungsanleitung, um die Installation einfacher zu machen und Spaß zu genießen.

## Installationsanleitung:

Vor der Installation lesen Sie bitte die Installationsanweisungen sorgfältig und befolgen Sie die relevanten Schritte, um die Installation erfolgreich abzuschließen.

## Wählen Sie die Installationsorte:

Ihre Vorratskammer muss auf einem festen Fundament installiert werden. Wenn es notwendig ist, werden die Quadrat- und Horizontaleinrichtungen vom Fundament errichtet. Der Standort muss windschutzfähig und trocken sein, und eine gute Entwässerungssystem haben. Das Paket hat kein Fundament. Sie können das Fundament separat kaufen oder selbst bauen.

## List für Bauteile und Zubehör:

Nach List von Teilen müssen Sie die Teile auf die Vollständigkeit überprüfen ( bitte ziehen Sie die Kunststoff-Schutzfolien vor der Installation ab, falls erforderlich, beachten und behalten Sie bitte die Etikett-Nummer ) :

## Werkzeuge erforderlich (siehe Abbildung):

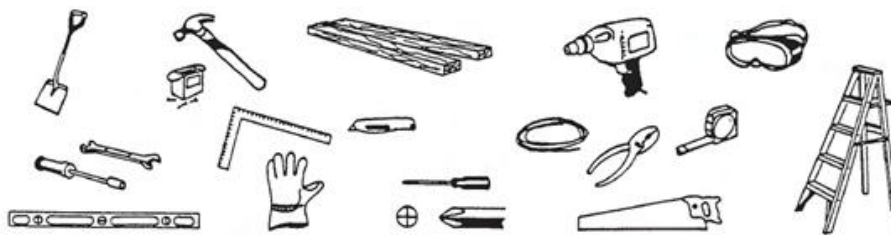

## Bitte achten Sie auf Sicherheit bei der Verwendung des Werkzeugs.

### Hinweis:

1. Wählen Sie einen trockenen und windstillen Tag zu installieren. Die Vorratskammer braucht die Zusammenarbeit von zwei oder mehr Personen ,um die Installation abzuschließen ;
2. Tragen Sie immer die Schutzhandschuhe, Schutzbrille und langärmelige Kleidung bei der Installation, um Verletzungen zu vermeiden; beachten Sie bitte auf die scharfen Ecken bestimmter Bauteile;
3. Kinder und Haustiere dürfen nicht die Baustelle betreten;
4. Man darf nicht das Gewicht des Körpers in der Decke zentralisieren. Bei der Verwendung von der Stufenleiter oder anderen Werkzeugen, bitte bedienen Sie richtig und um die Sicherheit zu gewährleisten;

### Wartung:

1. Man muss Innen- und Außenvorratskammer sauber halten. Wischen Sie mit einem weichen Tuch, wenn es notwendig ist , verwenden Sie auch sauberes Wasser;
2. Um einen reibungslosen Schiebetür zu gewährleisten, bitte halten Sie die Türschiene sauber, reinigen Sie den Schutt und Müll von der Türschiene.
3. Man muss rechtzeitig die Schneebedeckung abräumen, weil die schwere Schneebedeckung zu Zusammenbruch führen kann. Bitte bestätigen Sie die Sicherheit beim Eintritt ;
4. Die Vorratskammer dient **nur** für Vorrat von den Gegenständen, darf nicht als Residenz verwenden.

# MANUALE UTENTE

Si prega di verificarne la fondamenta, la posizione interessata, e rispettare leggi edilizie locali, di studiare e comprendere l'informazioni importanti e le precauzioni prima della costruzione al fine di facilitare l'installazione.

## Istruzioni sull'installazione:

Prima dell'installazione, assicurarsi di leggere le istruzioni attentamente e installarlo secondo la procedura relativa passo dopo passo affinché il risultato sia eccellente.

## Selezione della posizione d'installazione:

Il Suo box deve essere fissato su una superficie fissa. Se necessario, bisogna costruirvi fondamenta di forma quadrata. La posizione deve essere antivento, pulita, e asciutta con un bel sistema di drenaggio. Le fondamenta non sono inclusa nel presente kit, sono reperibili e vendibili separatamente.

## Elenco di componenti e ricambi:

Verificare se vi sono presenti tutti i componenti come da elenco (rimuovere la pellicola protettiva di plastica. Se necessario, prestare attenzione al numero dell'etichetta e mantenerlo):

## Attrezzi richiesti (vedere la foto):

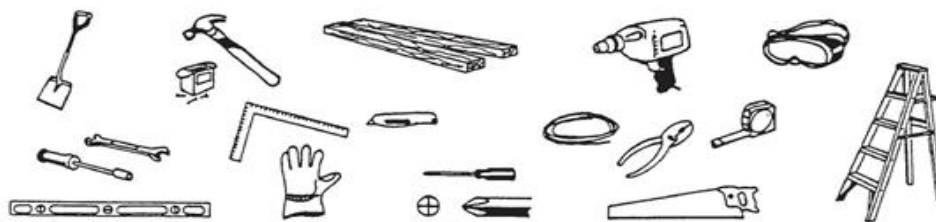

## Prestare attenzione alla sicurezza nell'uso degli attrezzi.

### Precauzioni:

- 1 Scegliere condizioni meteorologiche favorevoli senza vento per la costruzione. L'installazione del presente ripostiglio deve essere realizzata da due o più di due persone;
- 2 Si prega di munirsi di guanti di sicurezza, occhiali di protezione e vestiti a maniche lunghe per evitare ferite; fare attenzione agli spigoli;
- 3 Tenere bambini ed animali lontani dal sito di costruzione;
- 4 Non caricare il tetto con pesi eccessivi, potrebbe essere pericoloso. Durante l'utilizzo della scala prestare attenzione al posizionamento della stessa;

### Manutenzione:

- 1 Mantenere il box pulito internamente e esternamente, usando panni morbidi per strofinarlo. Se necessario è possibile lavarlo con acqua;
- 2 Lasciare libero lo spazio vicino alla porta in modo da agevolarne apertura e chiusura.
- 3 In caso di neve accumulata sul tetto deve essere immediatamente rimossa per evitarne il crollo. Verificare la sicurezza prima di entrare.
- 4 Il presente box è adibito al solo uso di ripostiglio, l'uso come dimora ne è proibito.

Size:

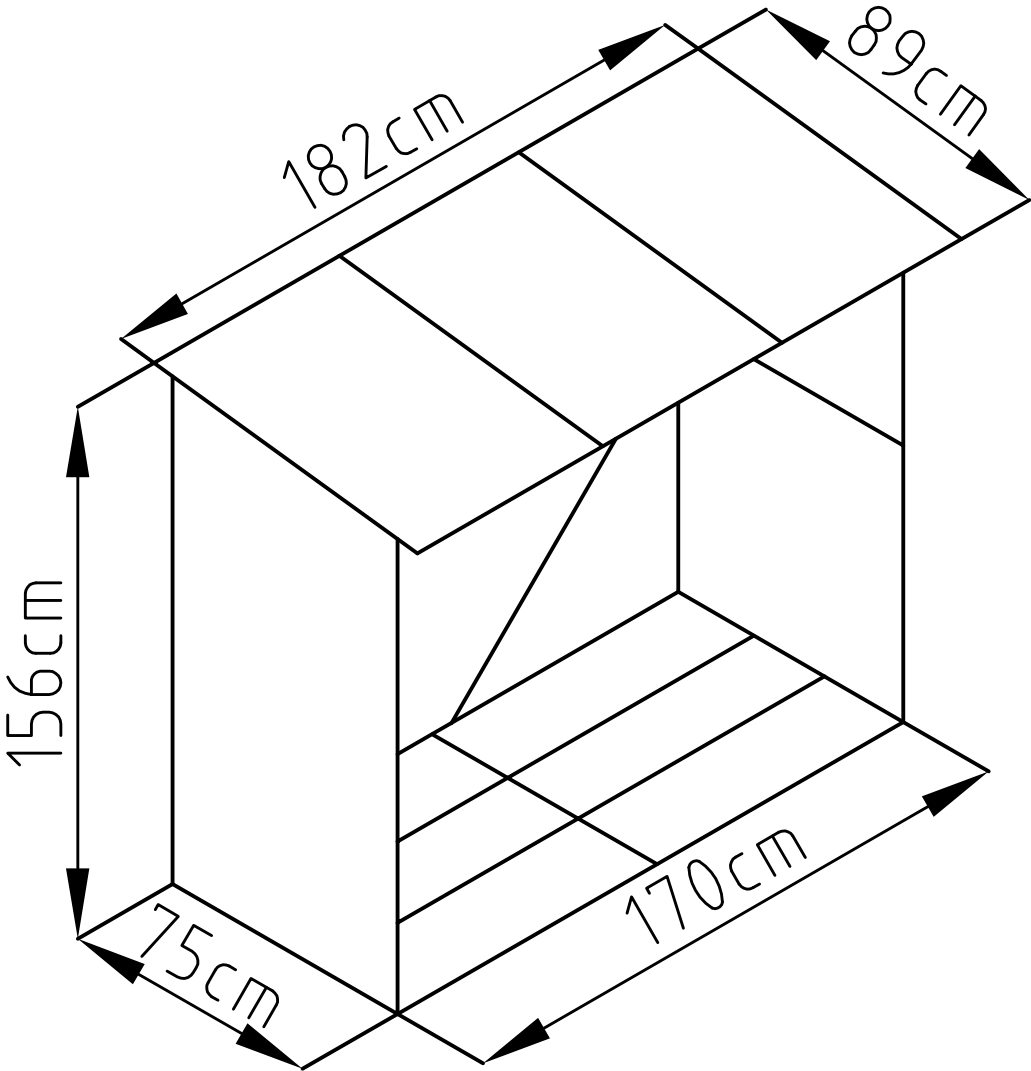

Area of installation requirement:

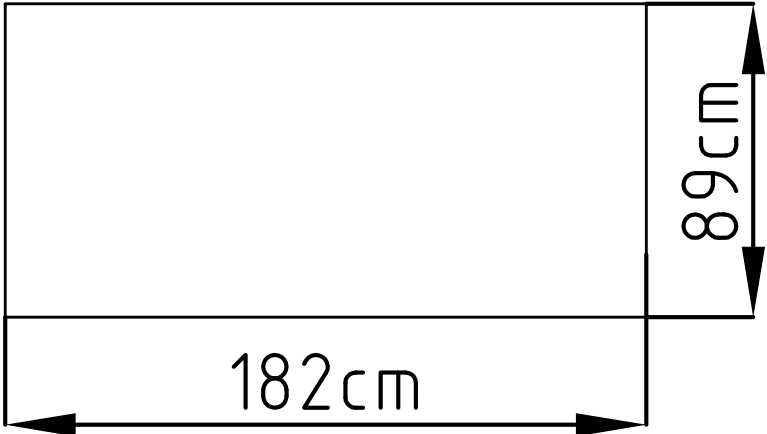



**NOTE:**It is important that these instructions are followed step by step.

Wood Storage must be installed on a level wooden platform or a level concrete foundation

please tear the PVC away before assembling

Wooden platform is extra and is not included.  
Don't install under windy conditions.

### Wooden Platform

The following are a list of lumber and sizes you will need.

#### Pressure Treated-Wood Studs:

50mmX101.6mmX910mm ..... (2)

50mmX101.6mmX1627mm ..... (3)

#### Exterior Grade (CDX-19mm) plywood

19mmX910mmX1830mm.....(1)

We recommend to clear your metal shed of snow after each snowfall.

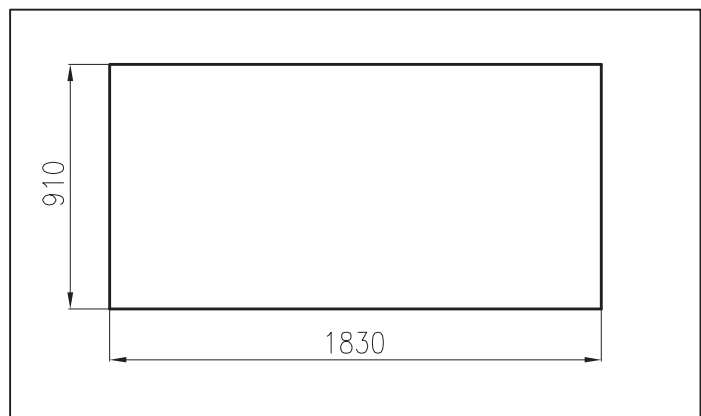
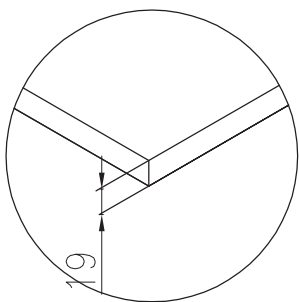
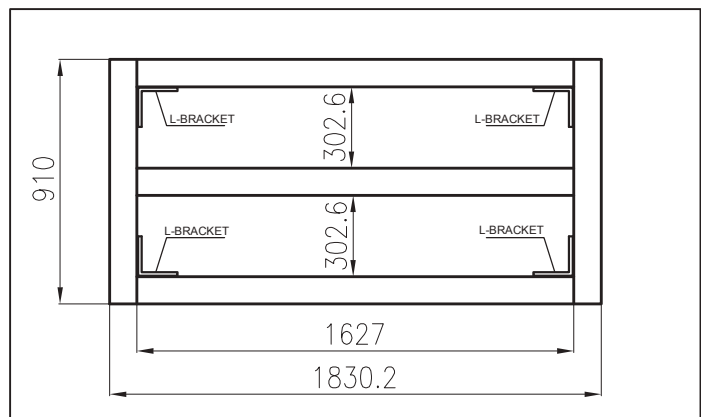
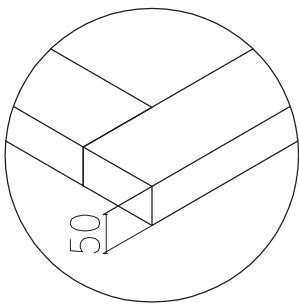



Important: Use hand gloves to prevent injury.

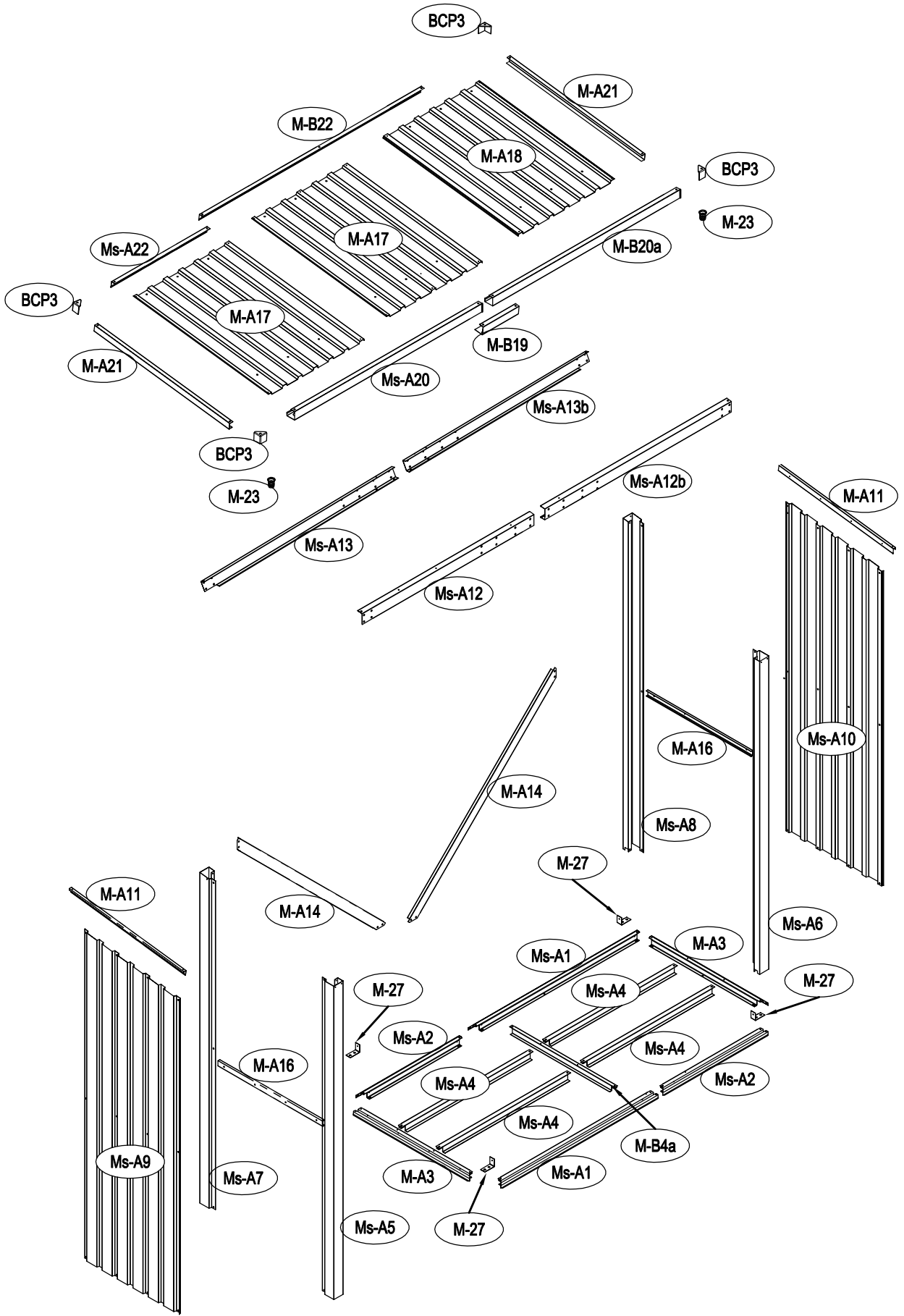



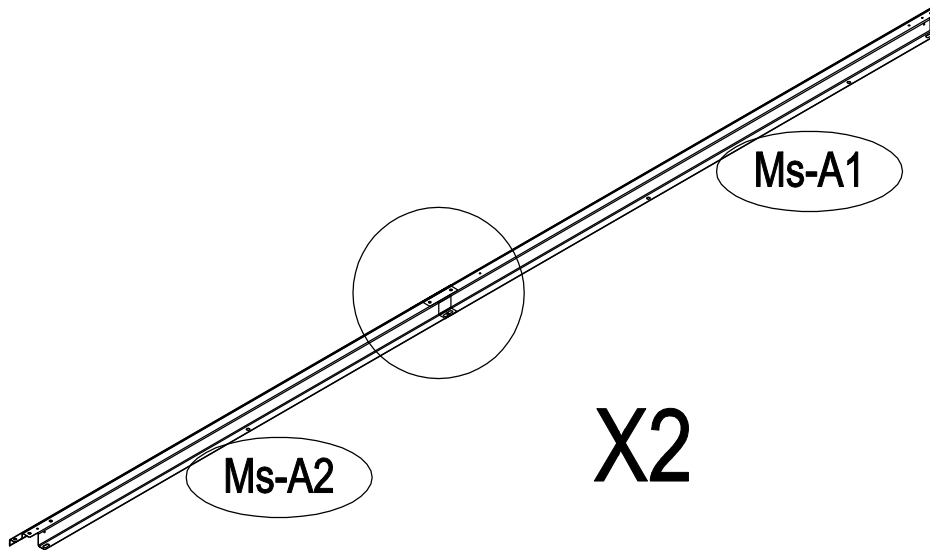
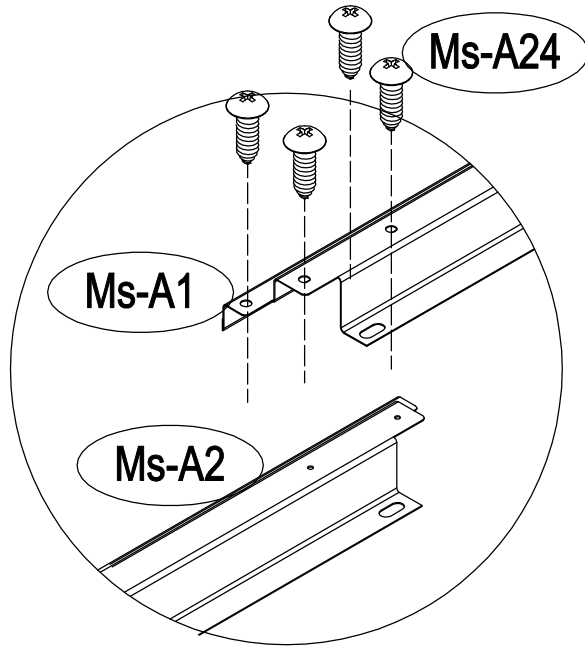

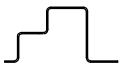
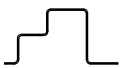

1

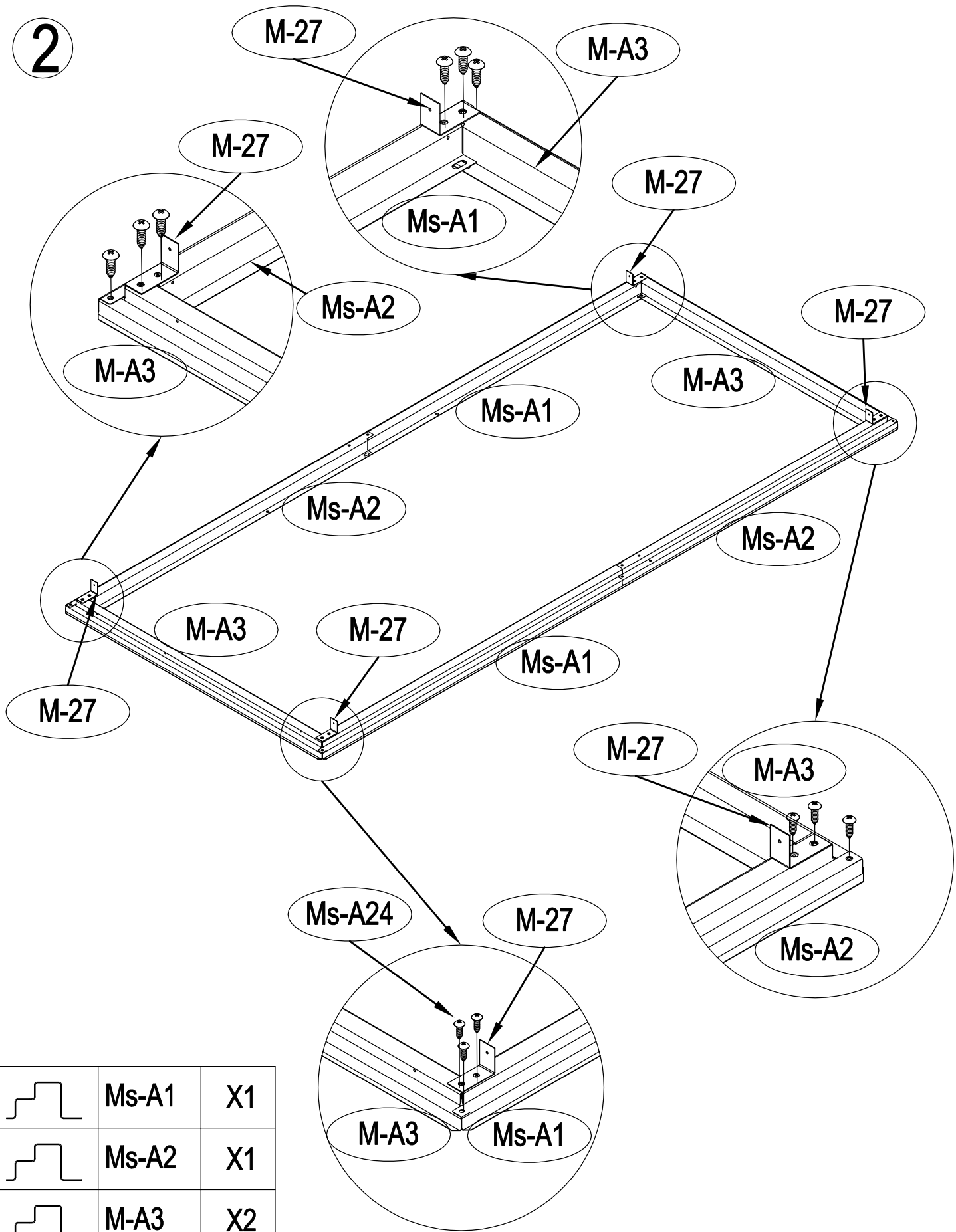

	Ms-A1	X1
	Ms-A2	X1
	Ms-A24	X8

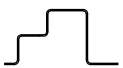

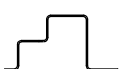
2



	Ms-A1	X1
	Ms-A2	X1
	M-A3	X2
	M-27	X4
	Ms-A24	X12

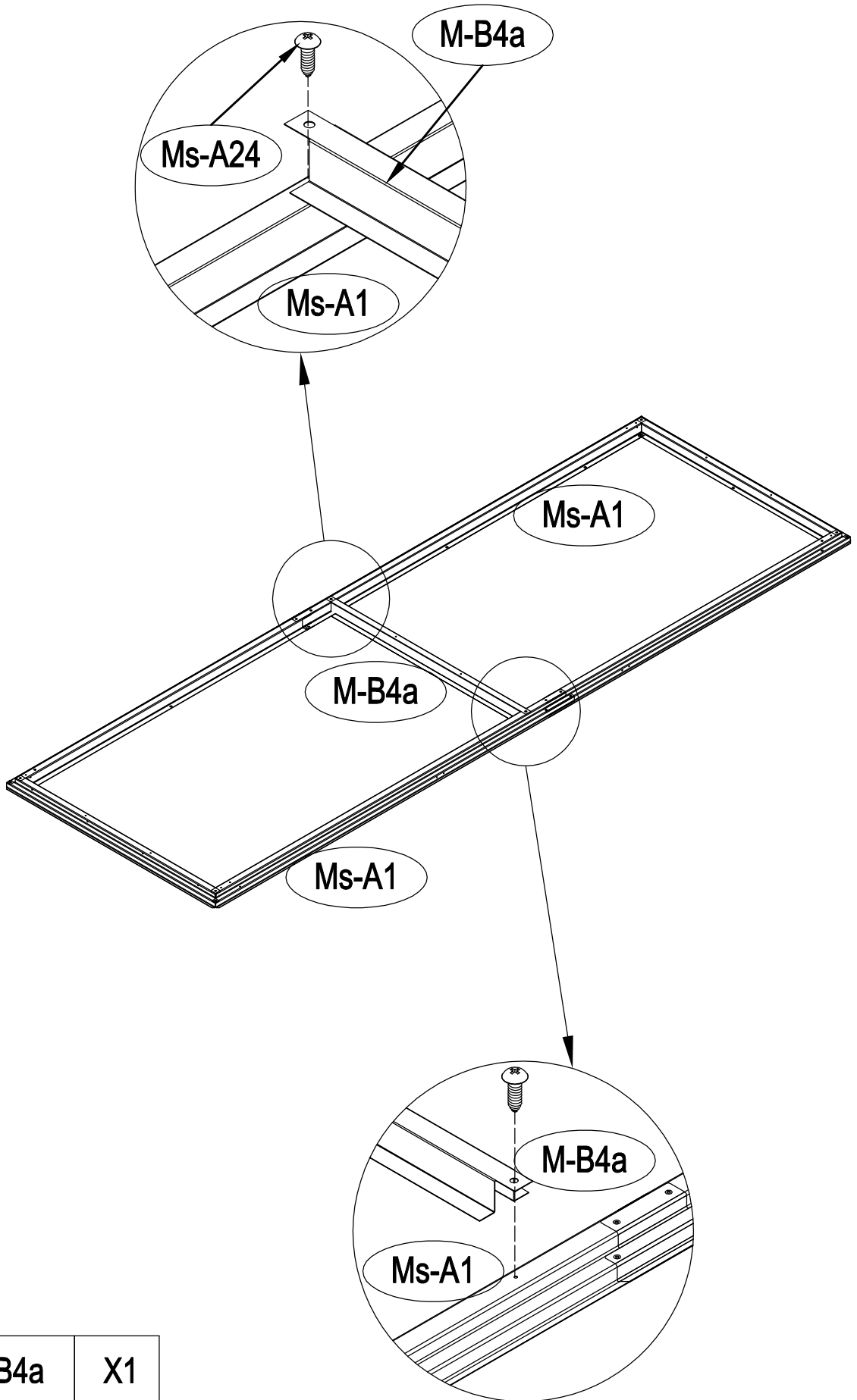

3



	M-B4a	X1
	Ms-A24	X2

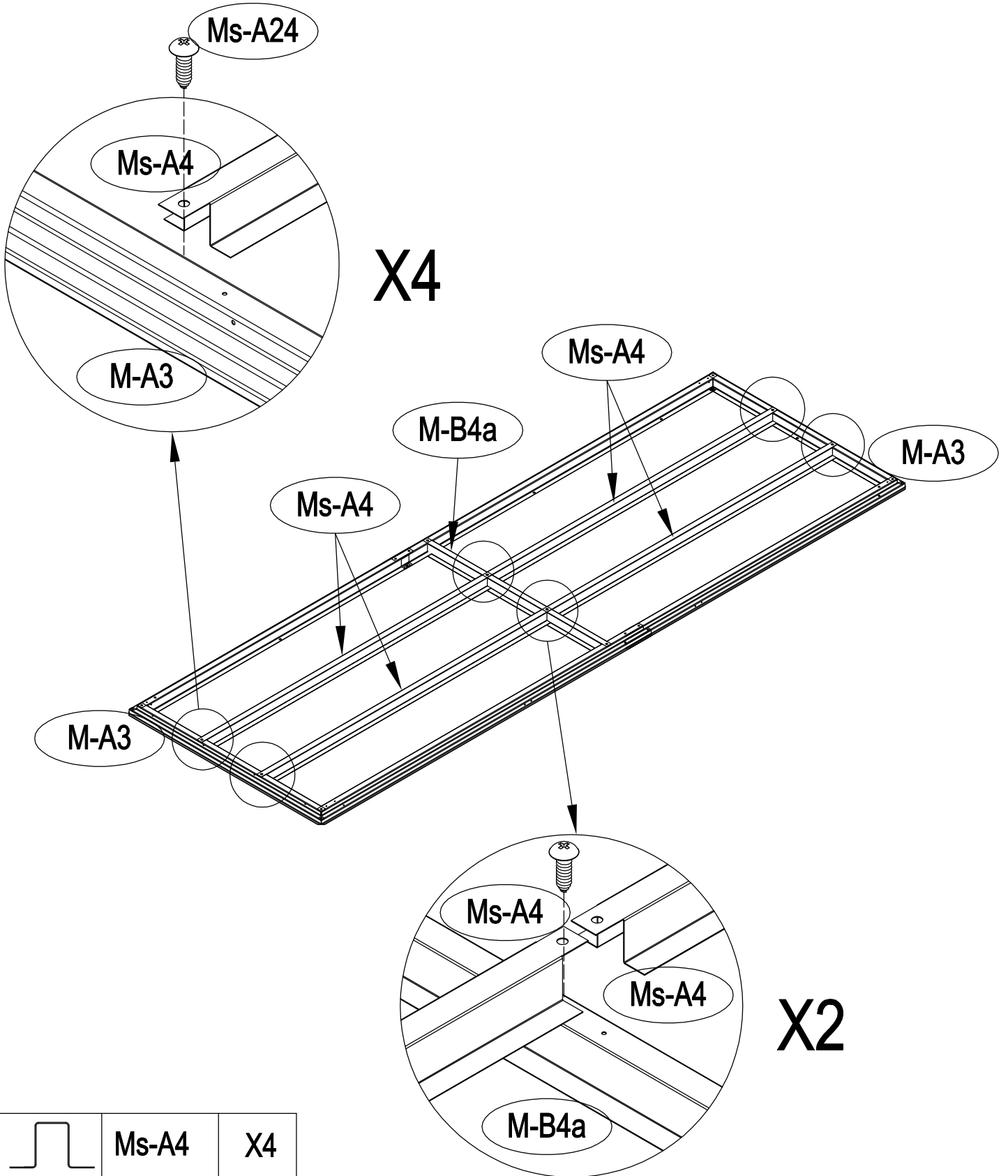





4

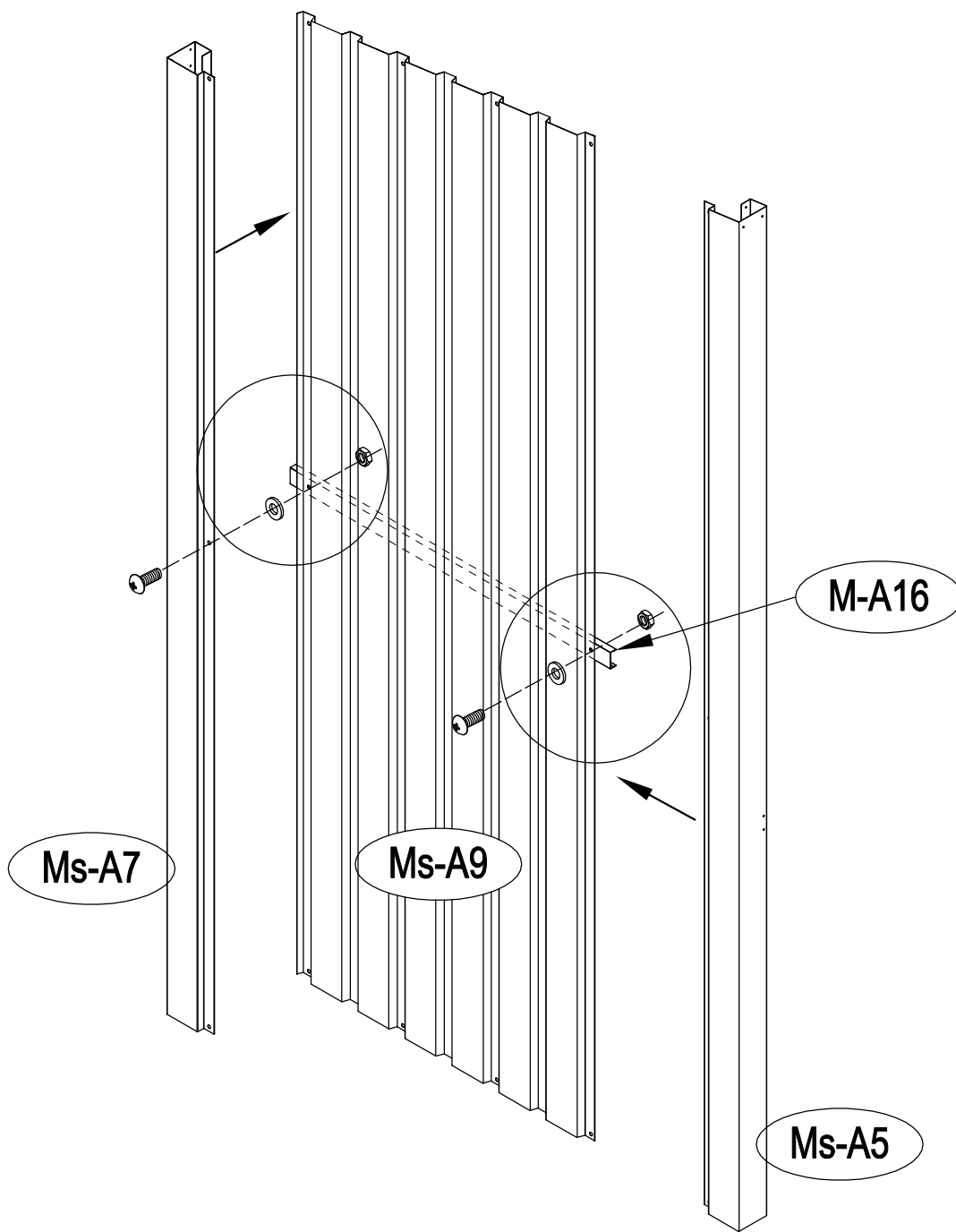

	Ms-A4	X4
	Ms-A24	X6

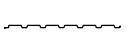
5





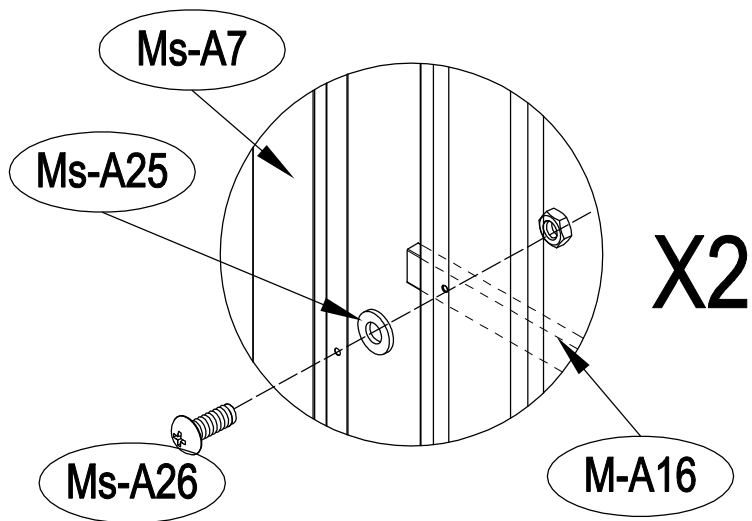

	Ms-A5	X1
	Ms-A7	X1
	Ms-A9	X1
	M-A16	X1
	Ms-A25	X2
	Ms-A26	X2



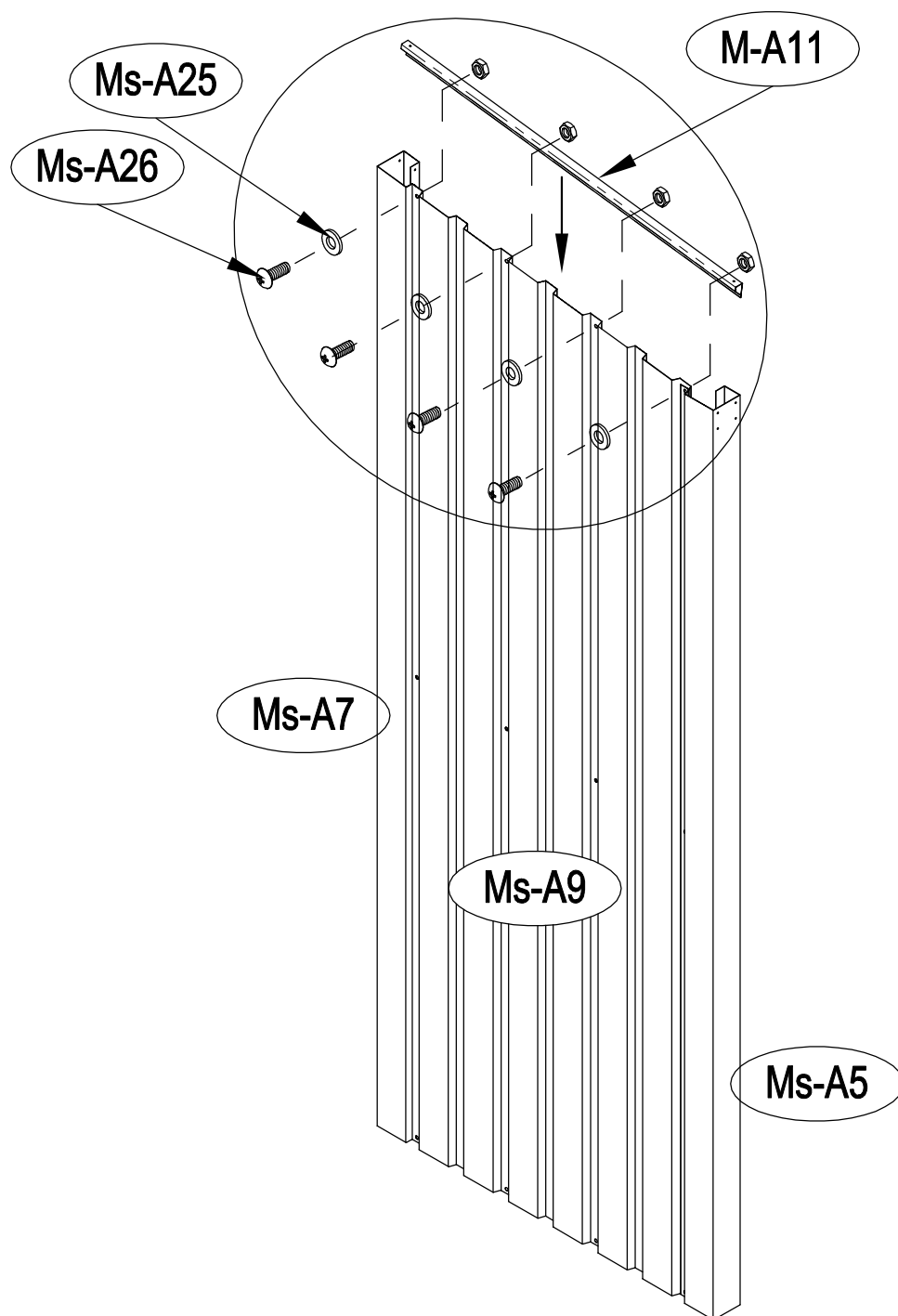



6



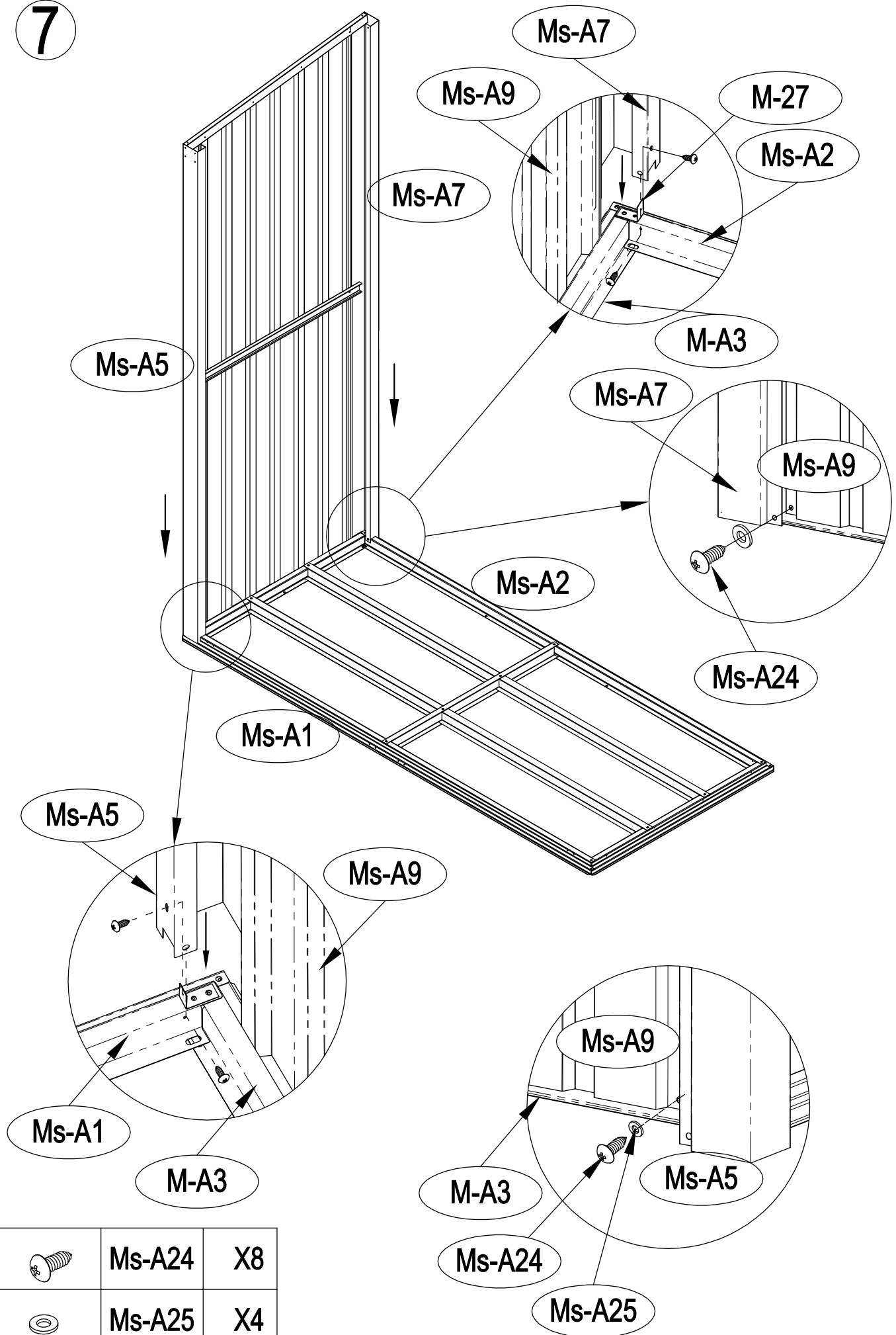

	M-A11	X1
	Ms-A25	X4
	Ms-A26	X4

7



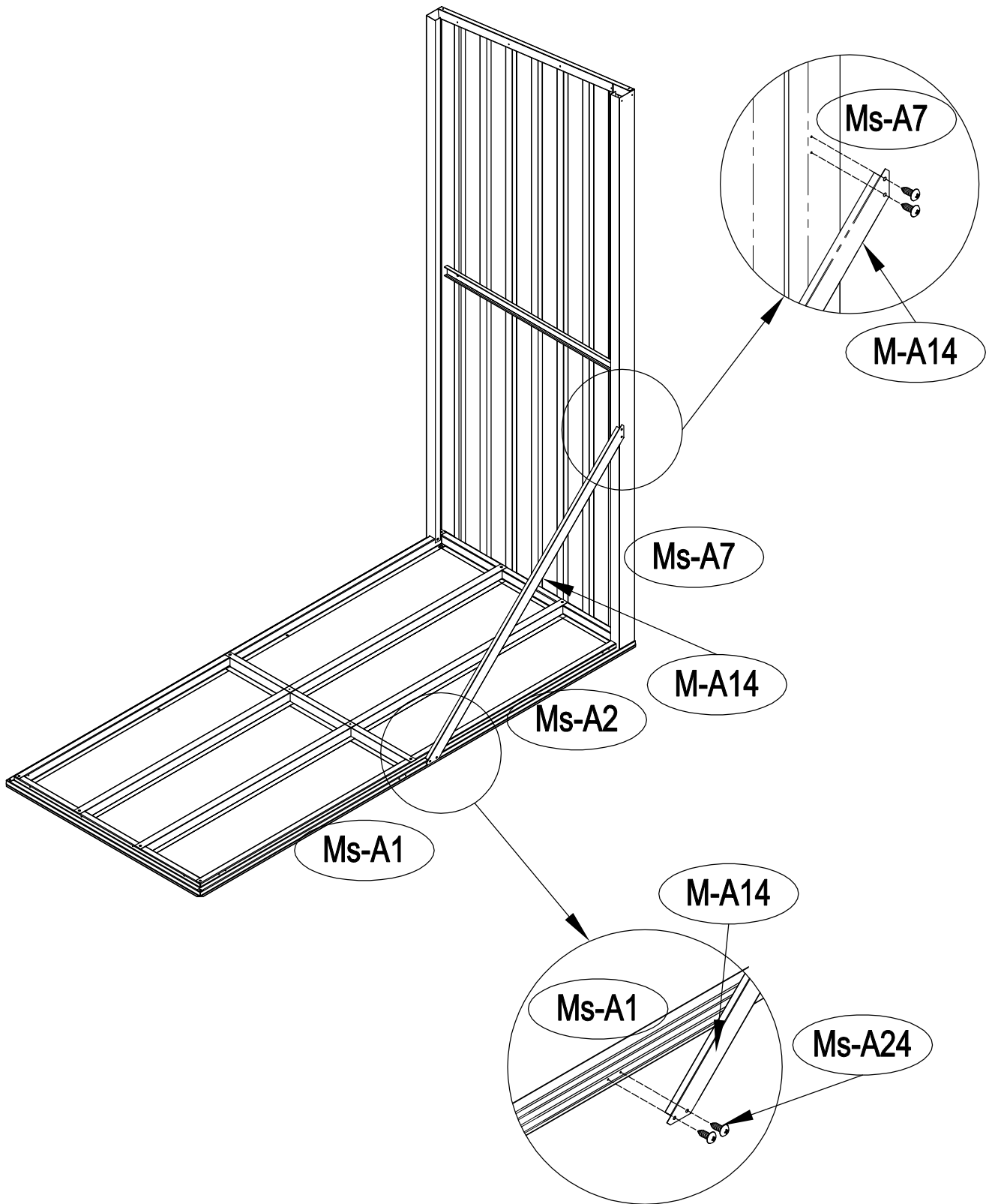





	Ms-A24	X8
	Ms-A25	X4

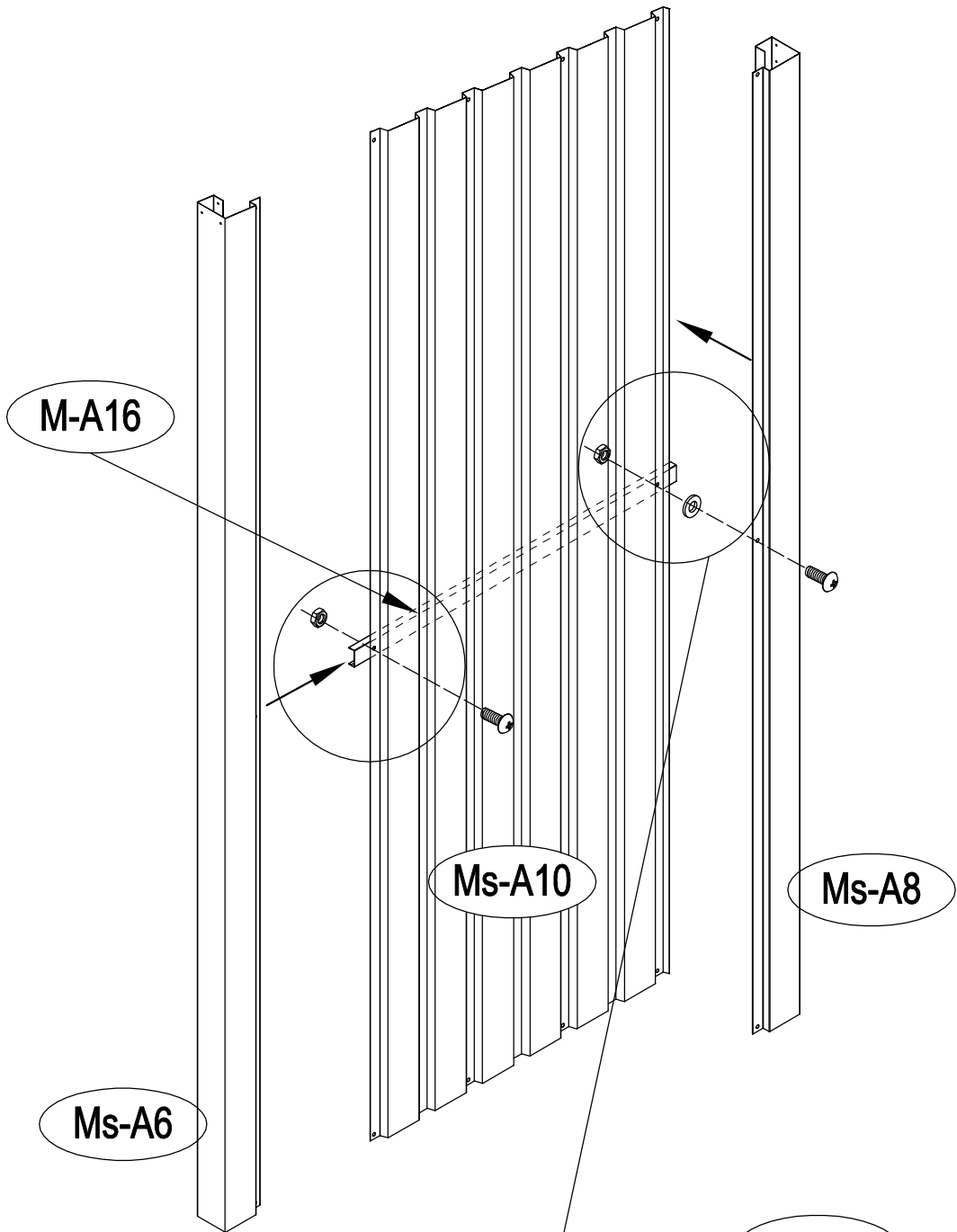

	M-A14	X1
	Ms-A24	X4

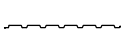

9

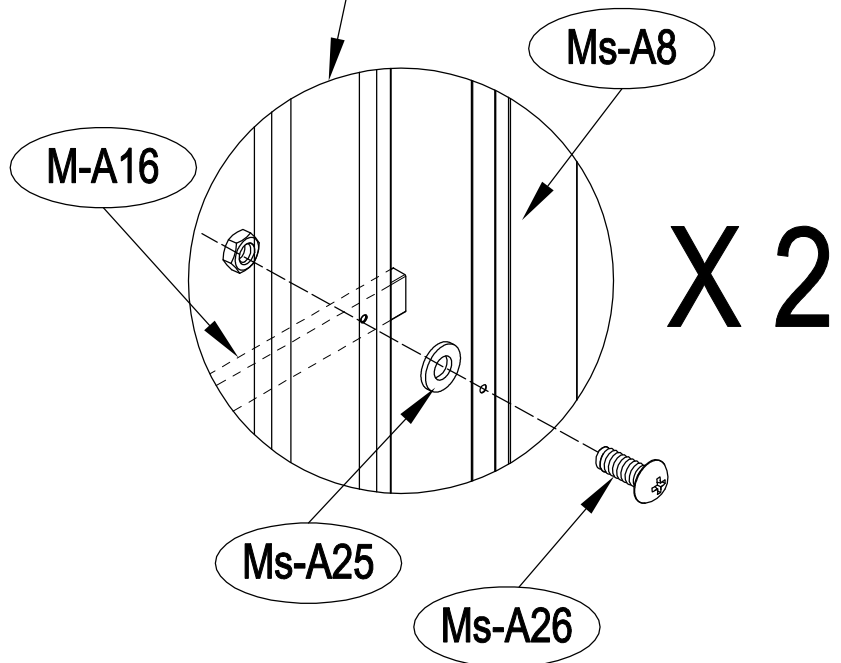

	Ms-A6	X1
	Ms-A8	X1
	Ms-A10	X1
	M-A16	X1
	Ms-A25	X2
	Ms-A26	X2

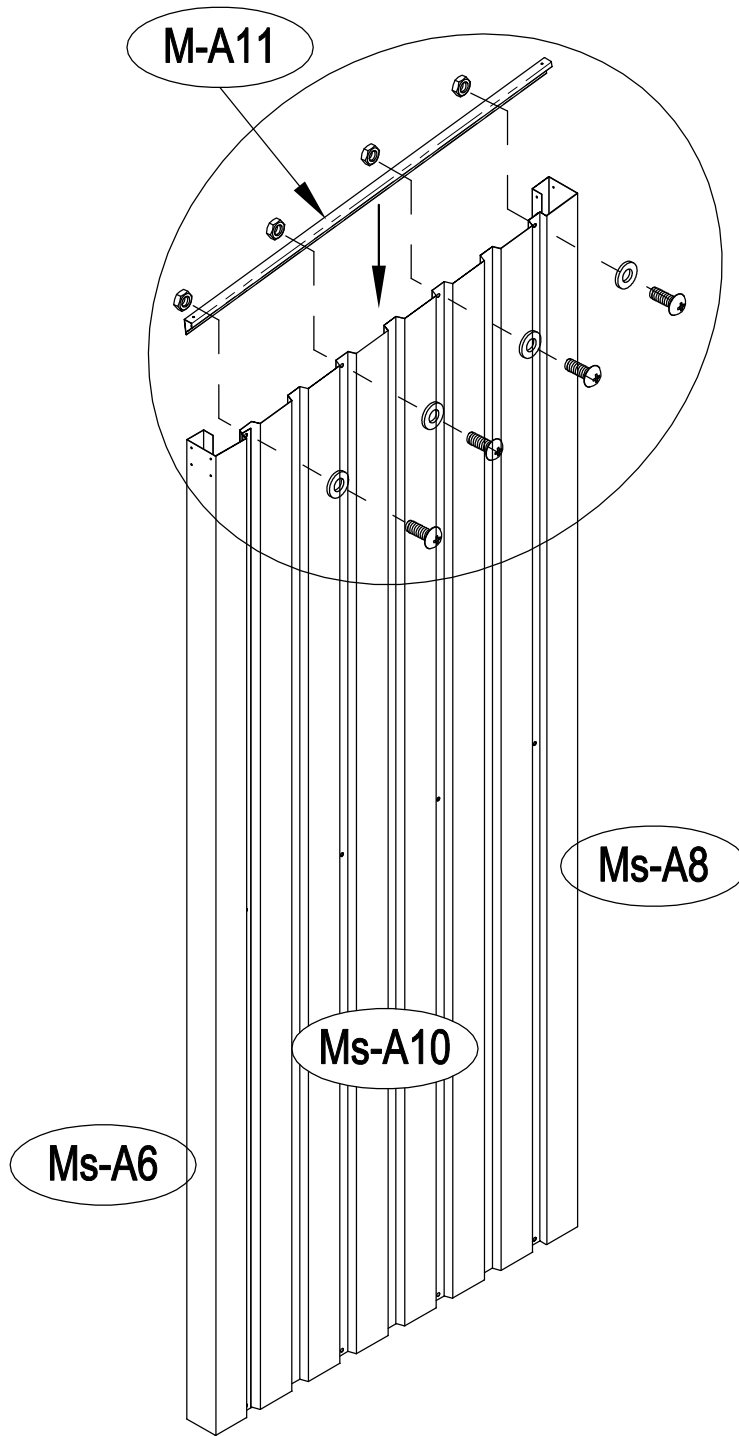





	M-A11	X1
	Ms-A25	X4
	Ms-A26	X4

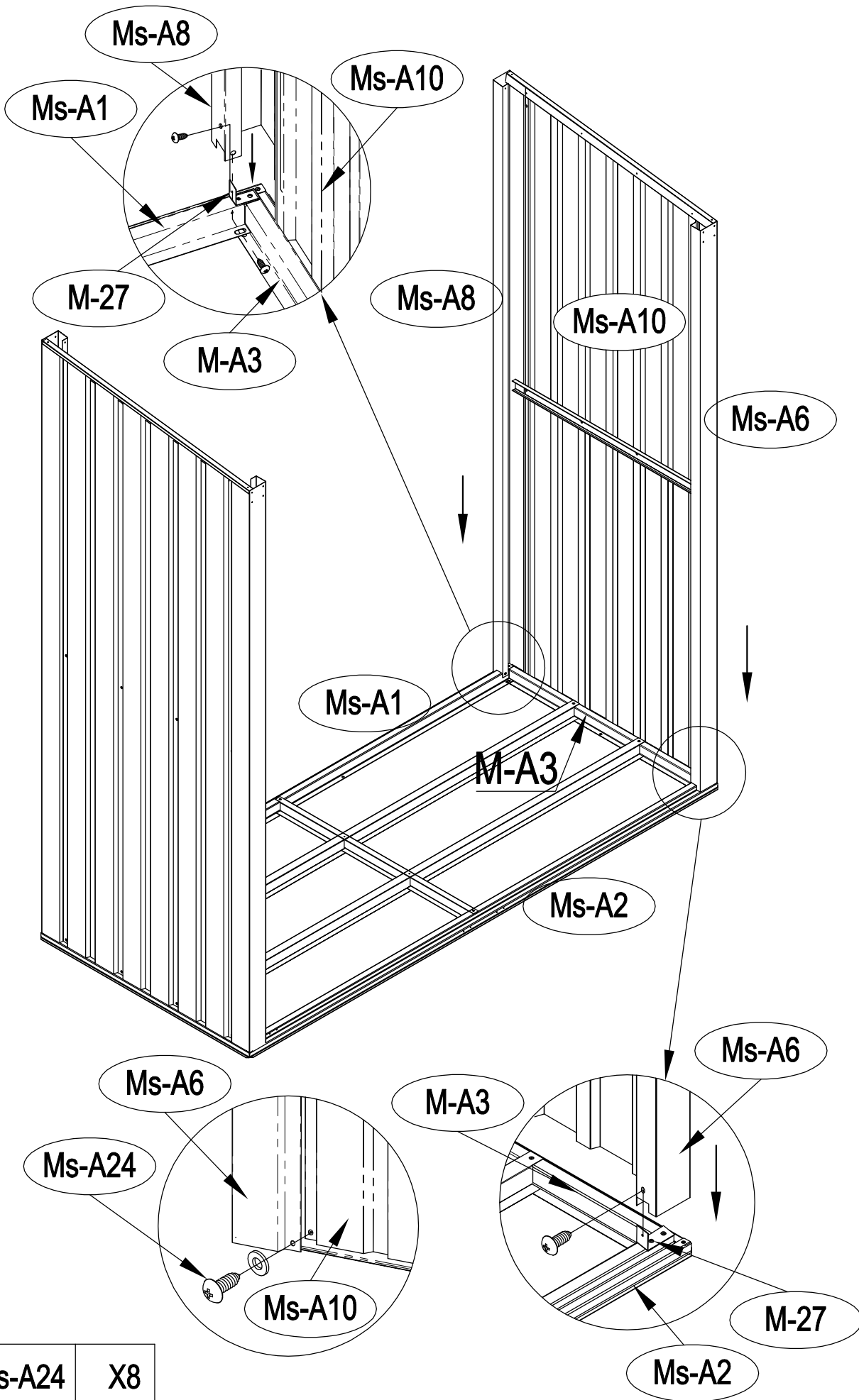

11





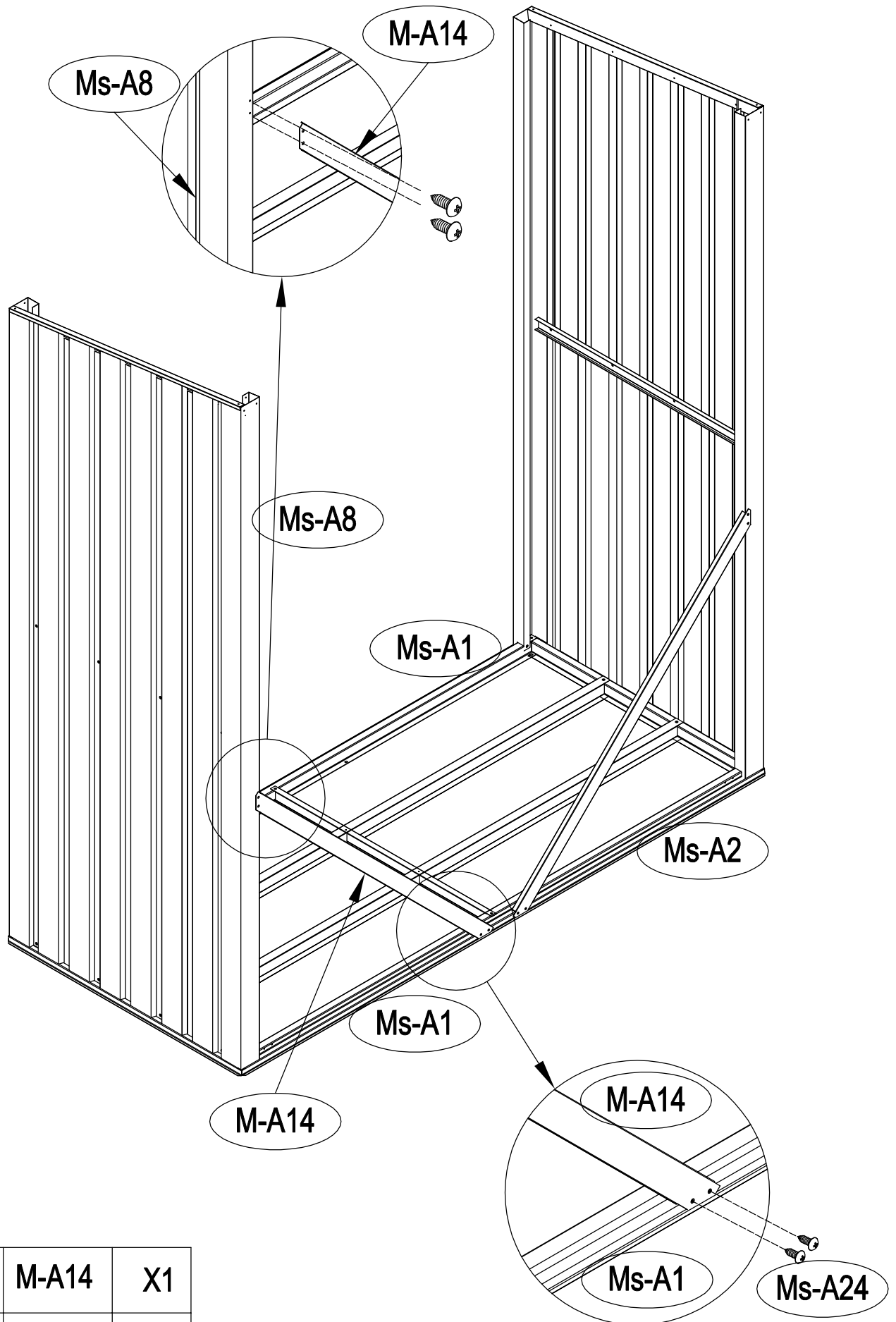

	Ms-A24	X8
	Ms-A25	X4

12

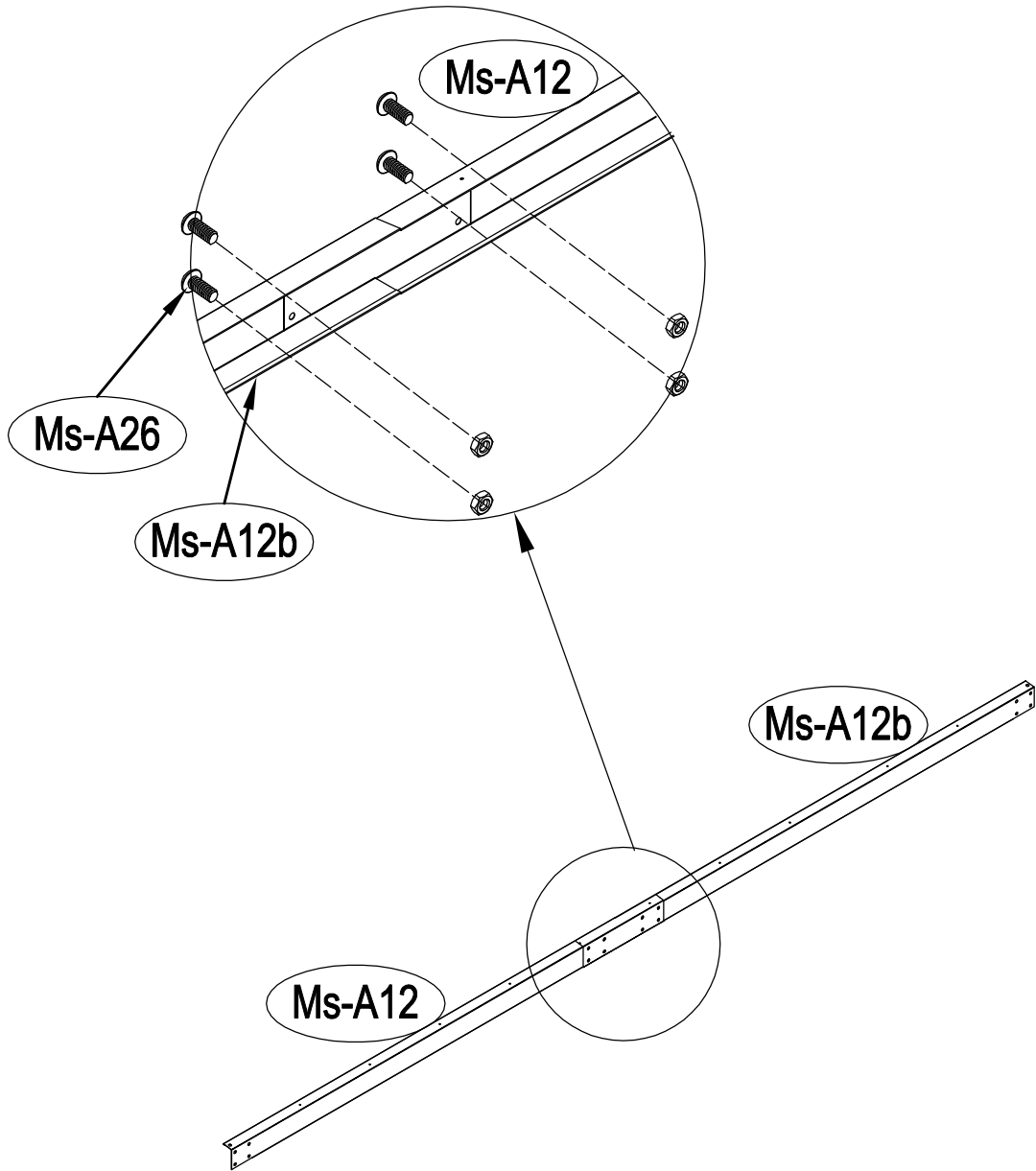



	M-A14	X1
	Ms-A24	X8





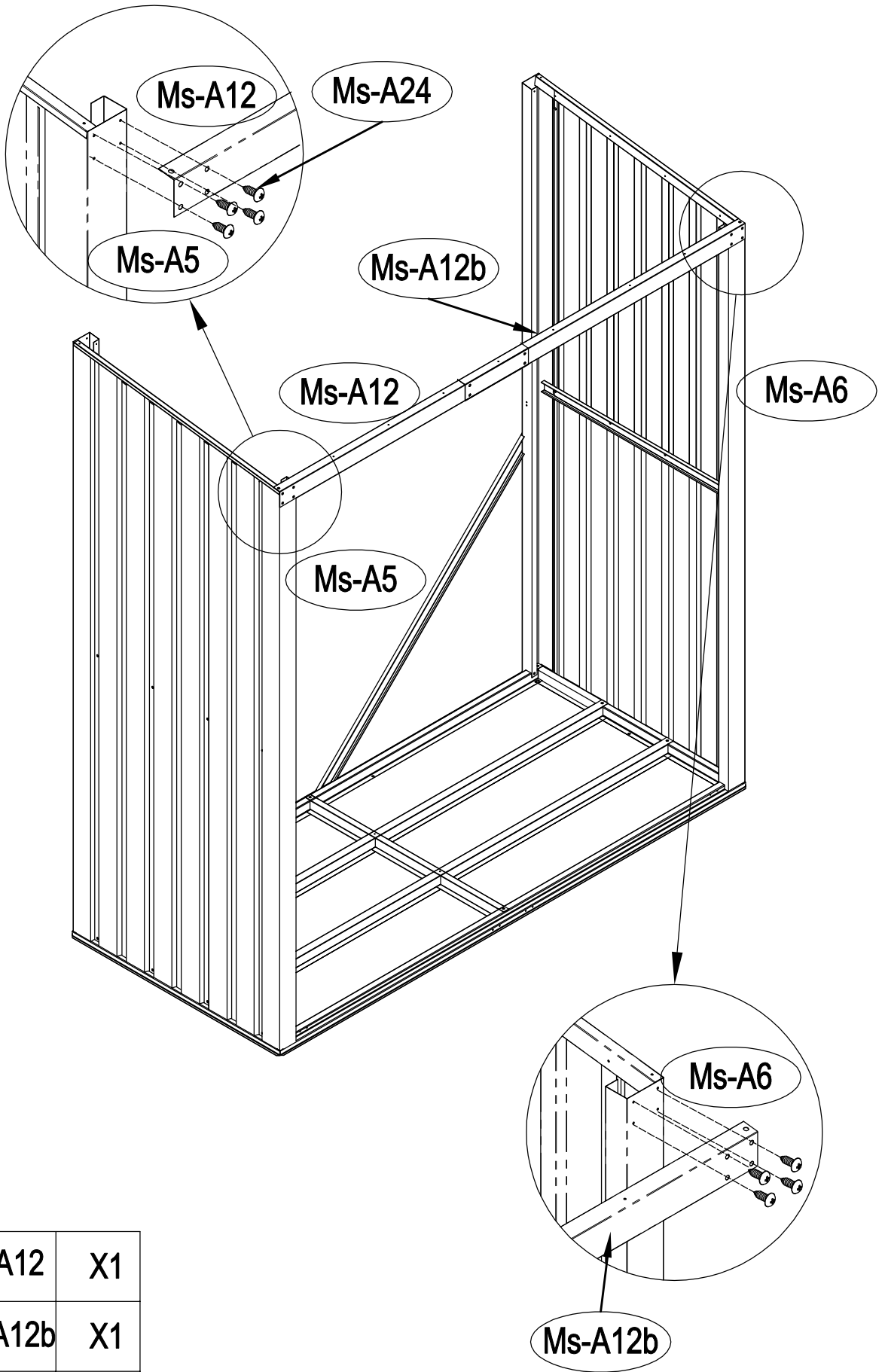

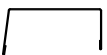
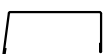
	Ms-A12	X1
	Ms-A12b	X1
	Ms-A26	X12



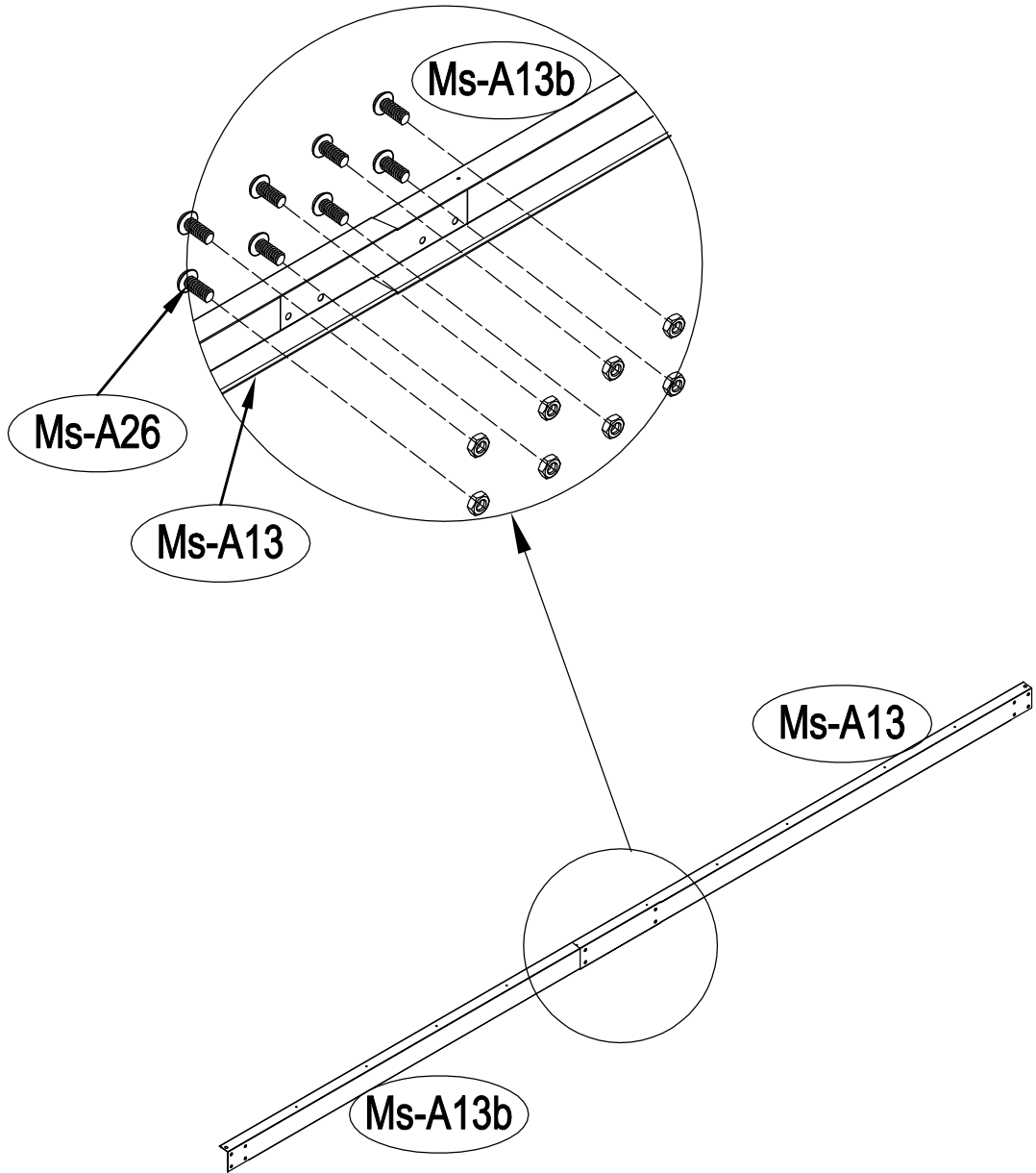



	Ms-A12	X1
	Ms-A12b	X1
	Ms-A24	X8



	Ms-A13	X1
	Ms-A13b	X1
	Ms-A26	X12

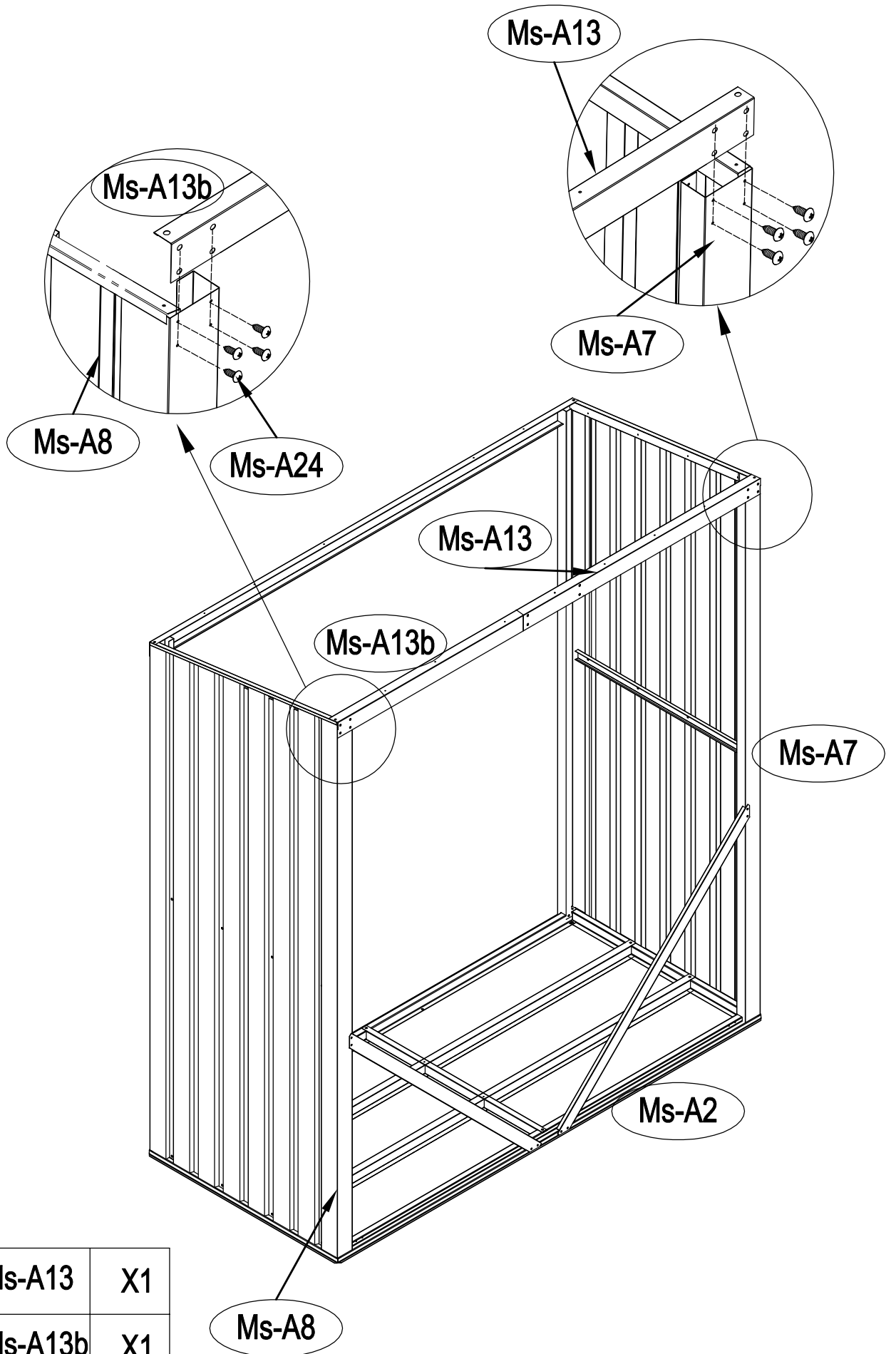

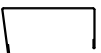
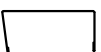
16



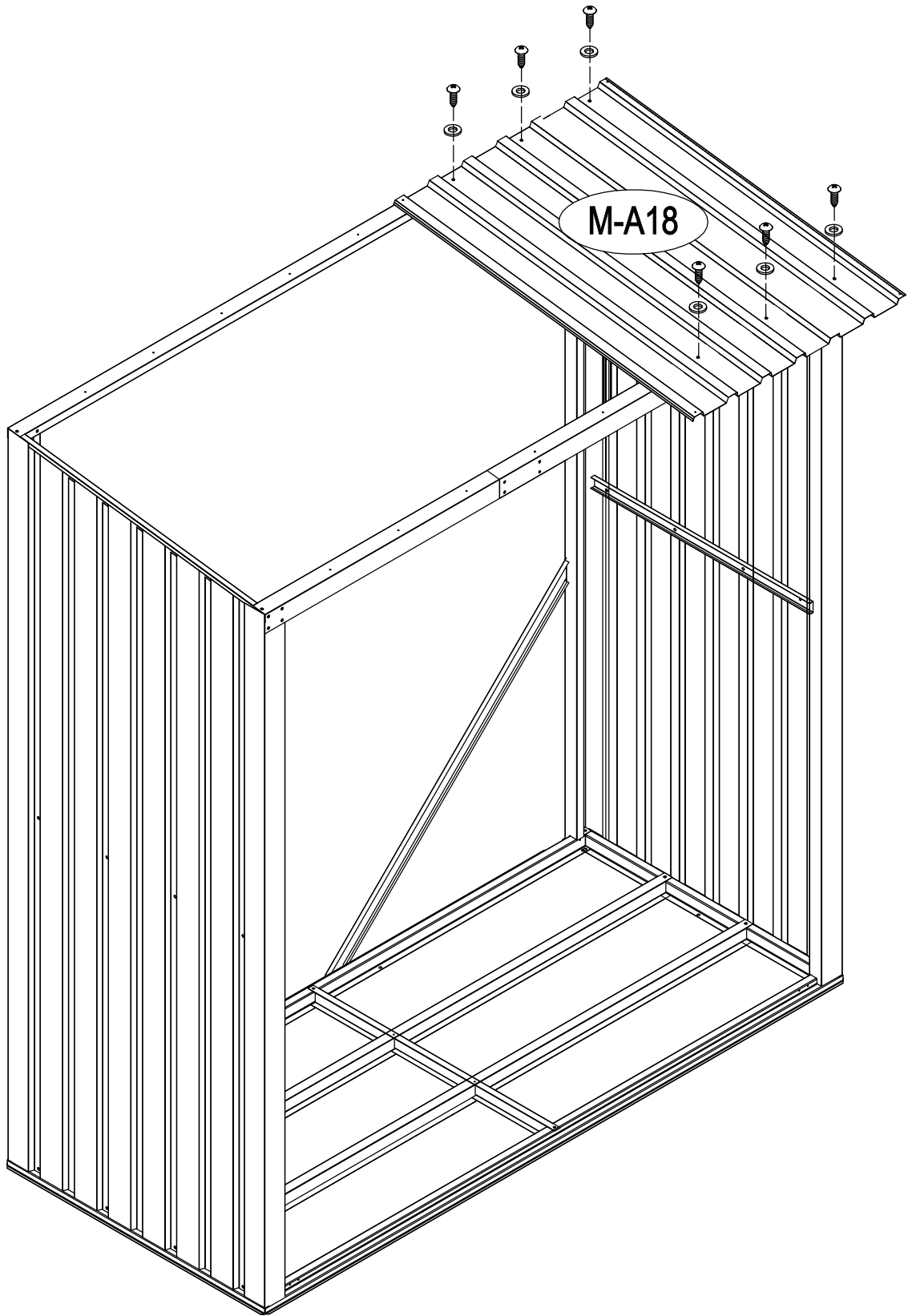

	Ms-A13	X1
	Ms-A13b	X1
	Ms-A24	X8

17



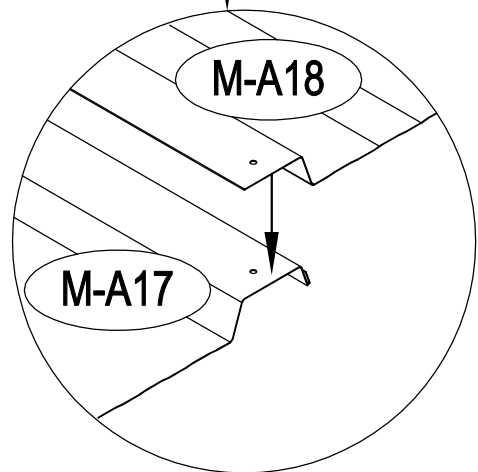
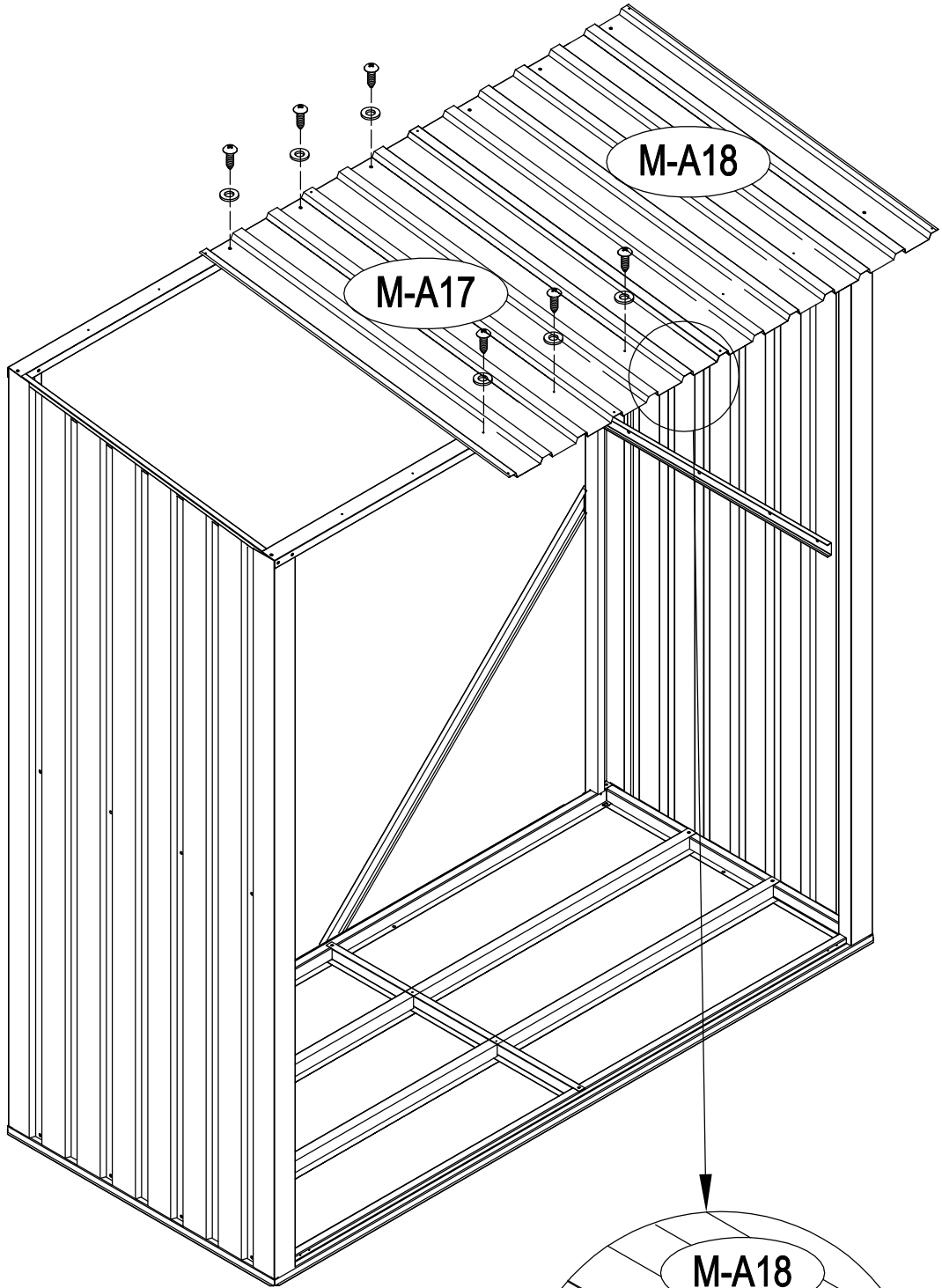

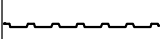
	M-A18	X1
	Ms-A24	X6
	Ms-A25	X6



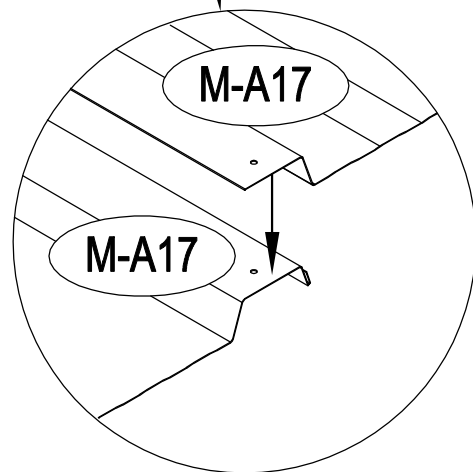
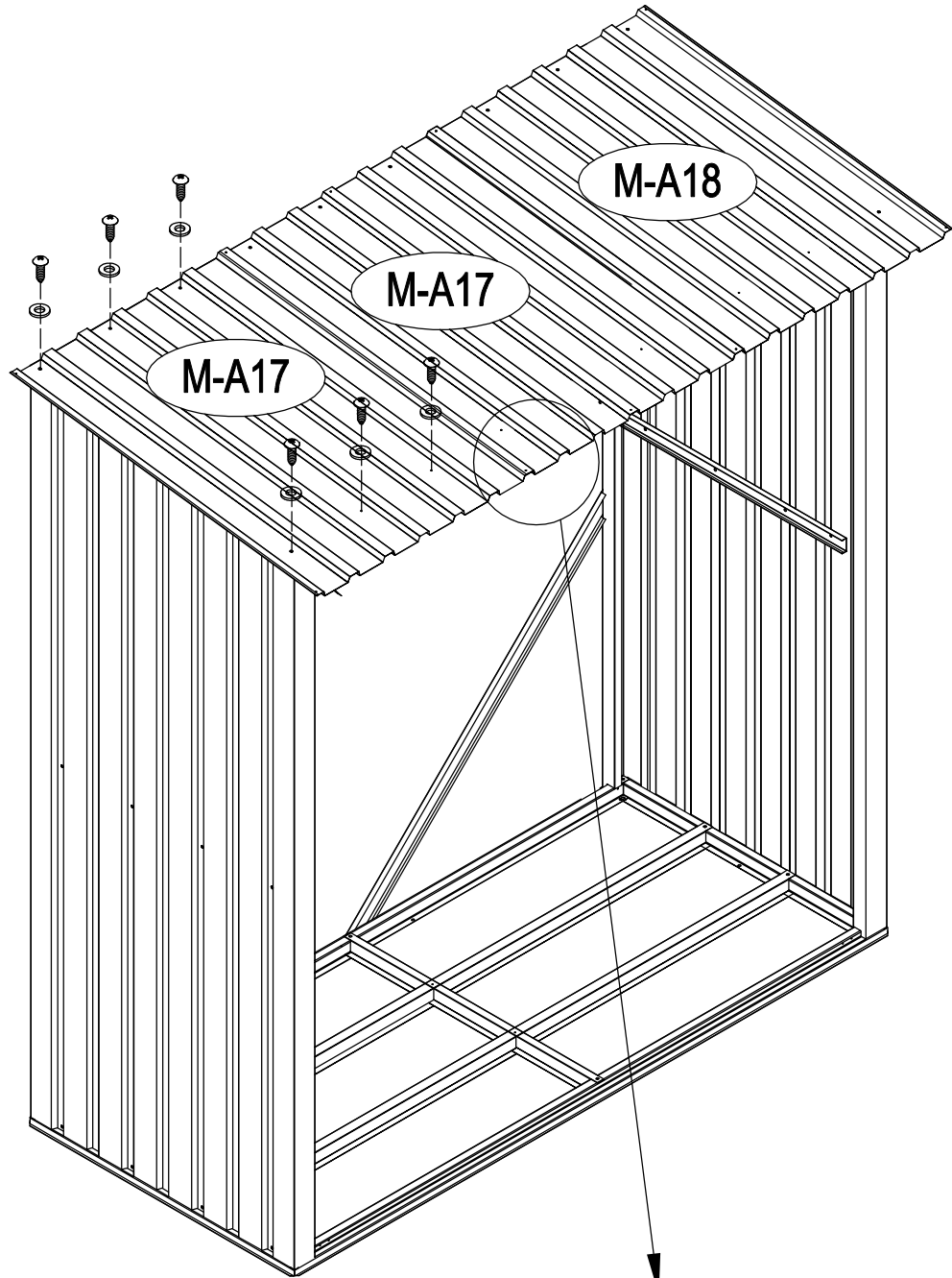

	M-A17	X1
	Ms-A24	X6
	Ms-A25	X6



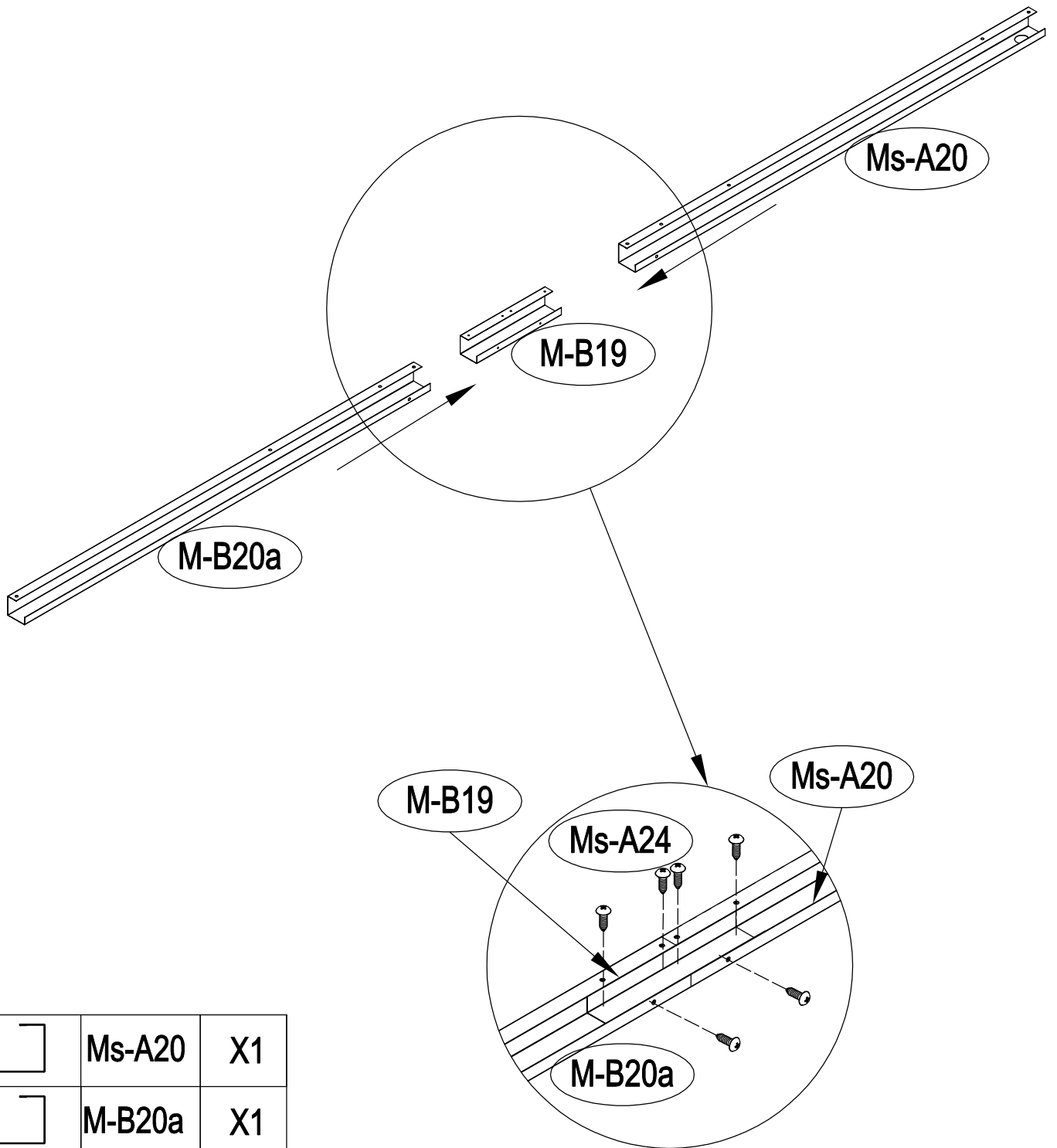



	M-A17	X1
	Ms-A24	X6
	Ms-A25	X6

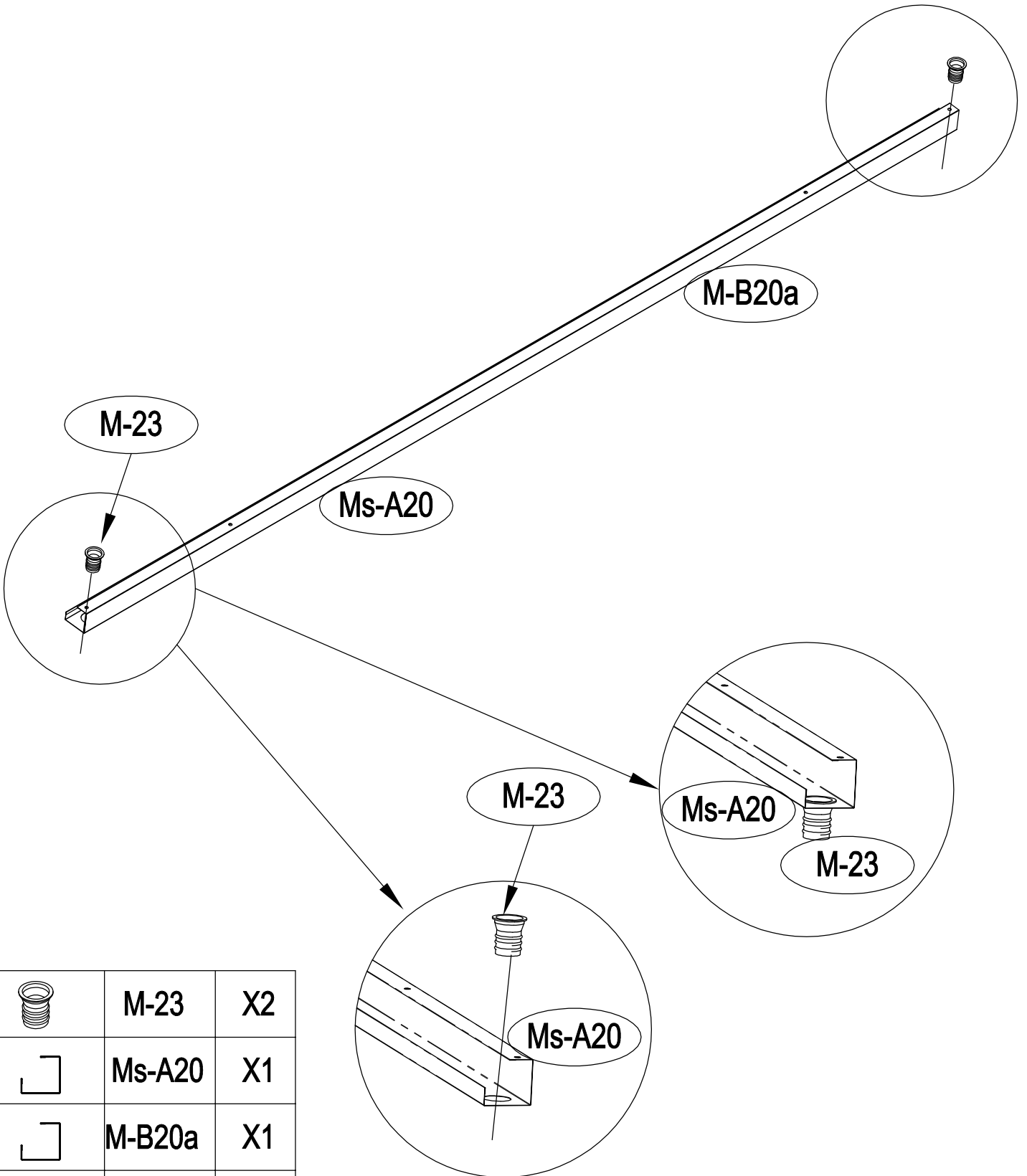





	Ms-A20	X1
	M-B20a	X1
	M-B19	X1
	Ms-A24	X6

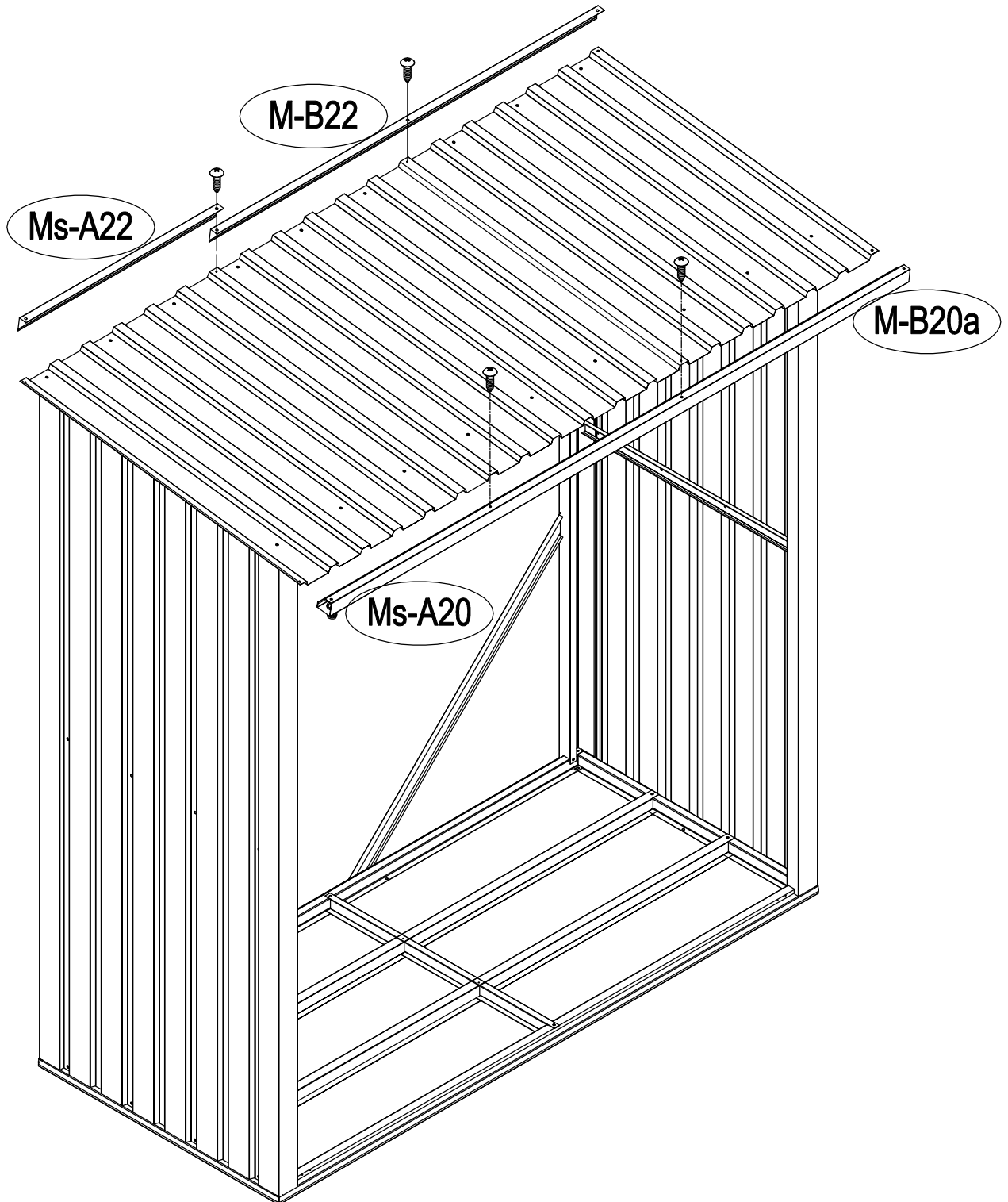

	M-23	X2
	Ms-A20	X1
	M-B20a	X1
	M-B19	X1





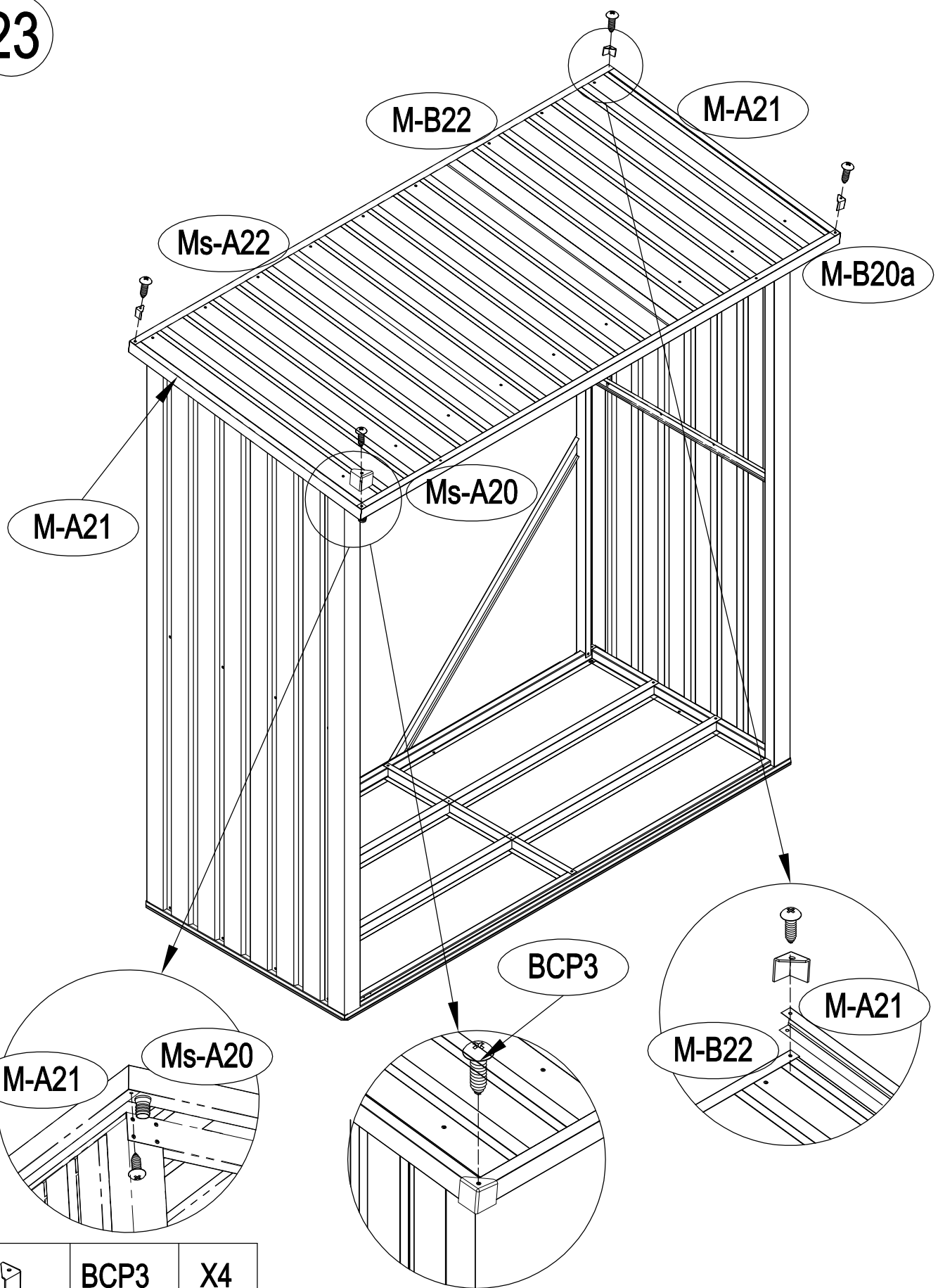

	Ms-A22	X1
	M-B22	X1
	Ms-A24	X4

23



	BCP3	X4
	M-A21	X2
	Ms-A24	X6

## Contact information

### Head office:

Dancover A/S  
Nordre Strandvej 119 G  
3150 Hellebæk  
Denmark

For more information  
please visit:  
[www.dancovershop.com](http://www.dancovershop.com)

## National contact

Denmark: 70 26 76 20  
[denmark@dancover.com](mailto:denmark@dancover.com)

UK: 020 8099 7570  
[uk@dancover.com](mailto:uk@dancover.com)

Germany: 041 0266 7040  
[germany@dancover.com](mailto:germany@dancover.com)

France: 0975 181 800  
[france@dancover.com](mailto:france@dancover.com)

Sweden: 040 233 262  
[sverige@dancover.com](mailto:sverige@dancover.com)

Finland: 0 931 581 720  
[suomi@dancover.com](mailto:suomi@dancover.com)

Poland: 22 300 8602  
[polska@dancover.com](mailto:polska@dancover.com)

Luxembourg: +49 041 0266 7040  
[luxembourg@dancover.com](mailto:luxembourg@dancover.com)

Portugal: 308 800 899  
[portugal@dancover.com](mailto:portugal@dancover.com)

Spain: 911 436 828  
[espana@dancover.com](mailto:espana@dancover.com)

Italy: 02 479 21 198  
[italia@dancover.com](mailto:italia@dancover.com)

Switzerland: 0840 000125  
[schweiz@dancover.com](mailto:schweiz@dancover.com)

Austria: 0662 626935  
[austria@dancover.com](mailto:austria@dancover.com)

Norway: 231 00 690  
[norge@dancover.com](mailto:norge@dancover.com)

Nederland: 0 858 880 524  
[nederland@dancover.com](mailto:nederland@dancover.com)

Ireland: 0 151 33 003  
[ireland@dancover.com](mailto:ireland@dancover.com)

Belgium: 0 28 08 08 09  
[belgique@dancover.com](mailto:belgique@dancover.com)