

DANCOVER[®]



Manual
for
Heater Borneo

Infrared Patio Heater

Safety Instructions and Operation Manual

HE94010

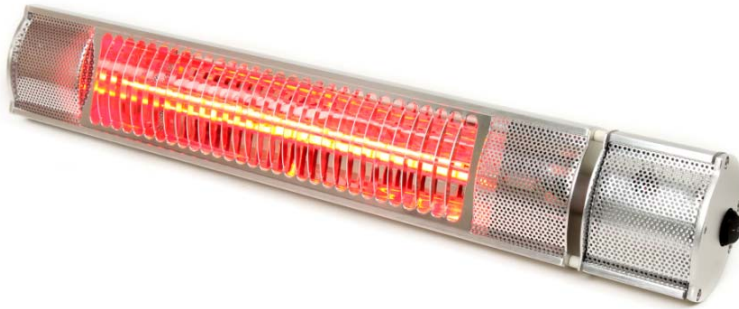

Thank you for purchasing from Heat Outdoors. Please read these instructions carefully before using your heater, and pay special attention to the "**Important Safety Instructions**". This product is an infrared radiant heater with a remote control and is IP65 approved for full outdoor use.

Important Safety Instructions

When using electrical appliances, basic safety precautions should always be followed to reduce the risk of fire, electric shock, or injury to persons, etc. Read all instructions before using this heater







- Keep combustible materials, such as furniture, pillows, bedding, papers, clothes and curtains at least 0.9m from the front of the heater.
- This appliance is not intended for use by persons (including children) with reduced physical, sensory or mental capabilities, or lack of experience and knowledge, unless they have been given supervision or instruction concerning use of the appliance by a person responsible for their safety.
- Turn off the electricity, remove the plug from the outlet when not in use.
- Do not try to repair by yourself if it is broken (such as cord, plug etc), please contact the service agent for maintenance.
- Do not run power cord under carpeting. Do not cover cord with throw rugs, runners, or similar coverings. Do not route cord under furniture or appliances. Arrange cord away from busy areas and where it cannot be tripped over.
- Connect to properly earthed outlets only. To disconnect heater, turn socket off, then remove plug.
- A heater has hot and arcing or sparking parts inside. Do not use it in areas where gasoline, paint, or flammable liquids are used or stored.
- Use this heater only as described in this manual. Any other use not recommended by the manufacturer may cause fire, electric shock, or injury to persons.
- Always plug heaters directly into a wall plug, fused spur or purpose made controller. Do not use the heater with a coiled cable or extension lead.

- Check if the voltage indicated on the nameplate of the appliance corresponds to the local mains voltage before you connect the appliance.
- The appliance is not to be located directly below an electrical wall socket.
- The casing and the front cover of the appliance become extremely hot during operation. Pay attention that, no combustible materials (due to wind or other environmental influences) covers or obstructs the appliance, such as curtains, marquees, flags, plastic foil etc.
- **Do not touch the appliance. Caution! Risk of scald injury!**
- In case of improper use, there is a risk of electrical shock and/or fire hazard. Operation of the appliance must be discontinued and remove the mains plug immediately. Do not try to repair the appliance by yourself. Please contact with the service agent or a suitably qualified electrician for maintenance.
- Remove the plug from the power outlet and wait until the appliance is sufficiently cool before cleaning.
- Keep out of reach of children. In order to keep children from dangers, never leave them unsupervised with the heater. Consequently, when selecting a suitable location, do so in such a way that children do not have easy access.

Specifications

Voltage (V)	220-240~ 50Hz
Power consumption (W)	2000W
Dimensions L×W×H (mm)	574.0×100.0×145.0
Weight (kg)	2.8
IP	IP65
Infrared receiving Angle	60°±5°
The control distance(M)	6
Battery type	2 x AAA size 1.5V

Remote Control Instructions

	Button	Graphic	Feature
	Up Arrow		Up one heating level
	Max		The heater goes directly to the highest heating level.
	Down Arrow		Down one heating level
	On		To switch the heater on: Press ON. The patio heater has a soft start function of 33% power. 4 seconds after the heater has been turned on, it will automatically switch to the last heating level used. In case of the first-time use, after 4seconds the heater will automatically switch to 100% power.
	Off		To switch the heater off: Press OFF. The heater will switch to standby mode(the receiver indicator will light up).

Notice:

- Use 2 pieces AAA size 1.5V batteries in the remote control. Remove the battery when not use for long time, thus the lifespan of remote control can be extended.
- Choose the same specification battery when replacing the battery inside, otherwise it may cause remote control not work, thereby affect the normal use of the heater.
- The heater can be still used in normal except remote control function if the remote control is missed or lost .Please contact service agent for further help if you need the function.
- The remote control function may be out of work if there is a barrier between the remote control and heater .
- Replacing the batteries duly so as not to affect the normal use of heater and remote control.



Operation Instructions

- Remove all packaging material (including anti-vibration packaging on the lamp) and check the appliance, supply cord and plug for signs of damage.
- Before mounting, note the minimum safe mounting distances and tilt angles as shown in the below must be strictly followed.
- The distance between the bottom edge of the appliance and the floor must be at least 1.8 M. See figure 3.
- There must be a distance of at least 0.2 M between the appliance and the ceiling, roof or other covers. See figure 3.
- There must be a distance of at least 0.5 M at each side between the appliance and walls or the like. See figure 3.
- Recommended angle to mounting surface is 45°. See figure 4.
- Fix the mounting bracket on the wall first. Ensure that the place to be installed is secure and firm. Or connect the appliance to a suitable floor stand.
- Adjust the desired angle and tighten the hex bolt on the hinge. Regularly the screws' fixing. Mechanical pressures and oscillation due to wind or rain can cause your fixing to work loose.
- Plug into a suitable power source and operate the via the remote control handset
- When not in use for long periods, it is advisable to remove the batteries

Figure1: Mounting bracket (wall bracket) and anchor dowels provided. Connection from the wall to the infrared heater.

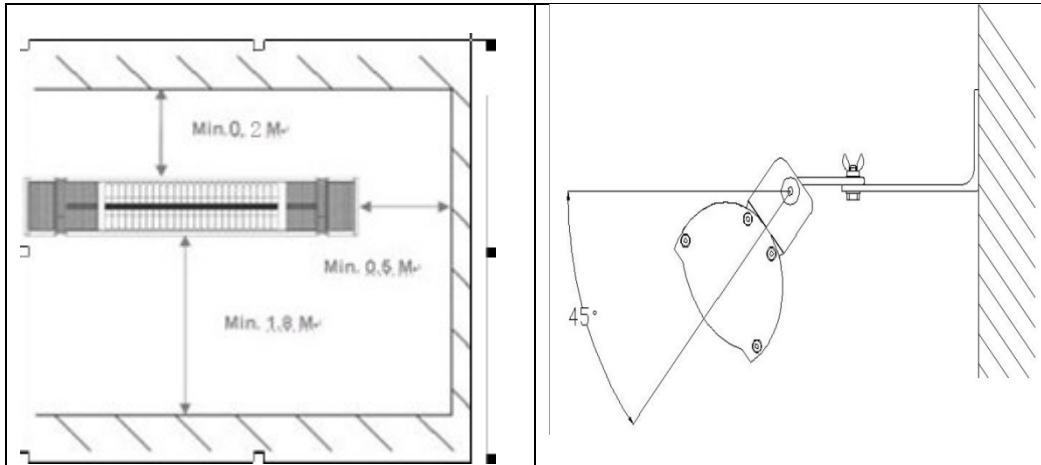

Figure 2: Connection from the stand to the infrared heater. The stand shall be purchased separately.



Figure3: Min. distance to floor, ceiling and wall.

Figure 4: Tilt angle



Cleaning and Maintenance

- This appliance is manufactured from robust and maintenance-free aluminium with a protective cover. There are no user serviceable parts inside.
- Before cleaning, remove the plug from the power outlet and wait until the appliance is sufficiently cooled off.
- Wipe the appliance only with clean and lint-free cloth or a soft brush.
- Never use abrasive cleaners, scrubbing brushes and chemical cleaners for cleaning!
- To protect against electrical shock and danger to life, do not immerse the cord, plug, or any part of this heater in water or any other liquid.
- For heating element replacement, please contact the manufacturer or its service agent or a similarly qualified person.
- For any other repairs, please contact the sales agent or a suitably qualified electrician.

Disposal



In accordance with European Directive 2001/96/EG concerning used electrical and electronic appliances (waste electrical and electronic equipment – WEEE), please return any electrical equipment that you will no longer use to the collection points provided for their disposal.

This symbol indicates that the appliance cannot be treated as normal domestic trash, but must be handed to a collection point for recycling electric and electronic appliances.

Information concerning where the equipment can be disposed of can be obtained from your local authority.

Customer Service

- This warranty does not cover damage of failure which results from alteration, accident, misuse, abuse, neglect, commercial use or improper maintenance.
- In line with our policy of continuous product development we reserve the right to change the product and documentation specifications without notice.

Contact information

Head office:

Dancover A/S
Nordre Strandvej 119 G
3150 Hellebæk
Denmark

For more information
please visit:
www.dancovershop.com

National contact

Denmark: 70 26 76 20
denmark@dancover.com

UK: 020 8099 7570
uk@dancover.com

Germany: 041 0266 7040
germany@dancover.com

France: 0975 181 800
france@dancover.com

Sweden: 040 233 262
sverige@dancover.com

Finland: 0 931 581 720
suomi@dancover.com

Poland: 22 300 8602
polska@dancover.com

Luxembourg: +49 041 0266 7040
luxembourg@dancover.com

Portugal: 308 800 899
portugal@dancover.com

Spain: 911 436 828
espana@dancover.com

Italy: 02 479 21 198
italia@dancover.com

Switzerland: 0840 000125
schweiz@dancover.com

Austria: 0662 626935
austria@dancover.com

Norway: 231 00 690
norge@dancover.com

Nederland: 0 858 880 524
nederland@dancover.com

Ireland: 0 151 33 003
ireland@dancover.com

Belgium: 0 28 08 08 09
belgique@dancover.com