

DANCOVER[®]

.com

Manual
for
Wooden Planter Box
0,69x0,33x0,6m

Installation manual

Montageanleitung • Notice de montage • Manual de montaje • Istruzioni per il montaggio • Installatiegids • Manual de instalação • Asennusohje • Monteringsanvisning • Installationsvejledning • Monteringsanvisning • Uzstādīšanas rokasgrāmata • Montavimo vadovas • Instrukcja instalacji • Návod k instalaci • Paigaldusjuhend

Flower box







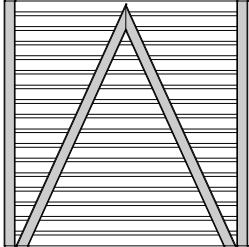
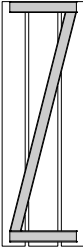

Blumenkasten • jardinière • jardinera • fioriera • bloembak • caixa de flores • kukkalaatikko • blomsterlåda • blomsterkasse • puķu kaste • gėlių dėžutė • skrzynka na kwiaty • květinový bedna • Lillekast

Width 690 x Depth 338 cm

Breite/Tiefe • Largeur/Profondeur • Ancho/Profundidad • Lunghezza/Profondita • Breedte/Diepte • Largura/Profundidade • Leveys/Syvyys • Bredd/Djup • Bredde/Dybde • Platums/Dzīlums • Plotis/Aukštis • Szerokość/Głębokość • Šīrka/Hloubka • Lais/Sūgavus

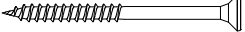
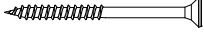

The producer shall have the right to make technical changes to the product • Technische Änderungen vorbehalten • Le producteur réserve le droit d'effectuer des modifications techniques au produit • Il produttore mantiene il diritto di apportare modifiche tecniche al prodotto • Reservado el derecho a modificaciones técnicas • Produsent forbeholder seg retten til å endre tekniske egenskaper ved produktet • Alle rechten en technische wijzigingen voorbehouden • Tootja jätab endale õiguse muuta toote tehnilisi omadusi

EL1		658 x 585 x 32	2
EL2		338 x 585 x 32	2
1		32 x 40 x 626	2
2		16 x 120 x 658	1
3		16 x 95 x 274	1
4		16 x 45 x 690	2
5		16 x 45 x 248	2
F1	 QKRPP4_5x40Zn	∅ 4,5 x 40	6
F2	 QKRPP3x35Zn	∅ 3 x 35	34
F3	Textile	600 x 1900 mm	1
F4		For F3, Not included	

1

2

3

4

A

A

B

B

C

C

D

D

E

E

F

F

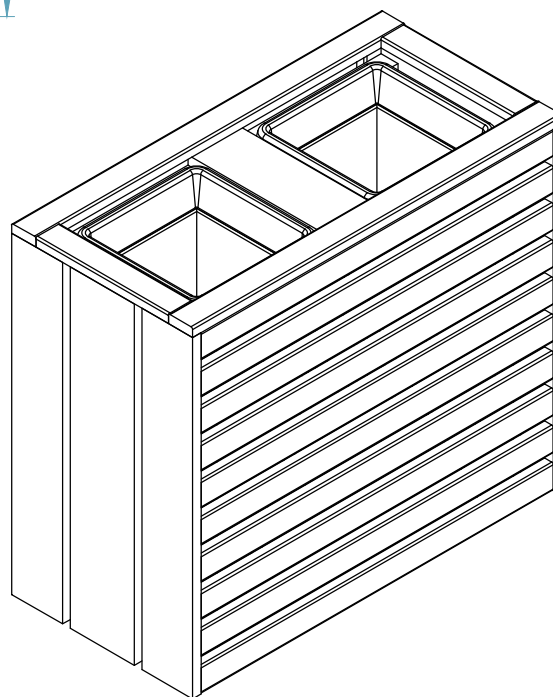
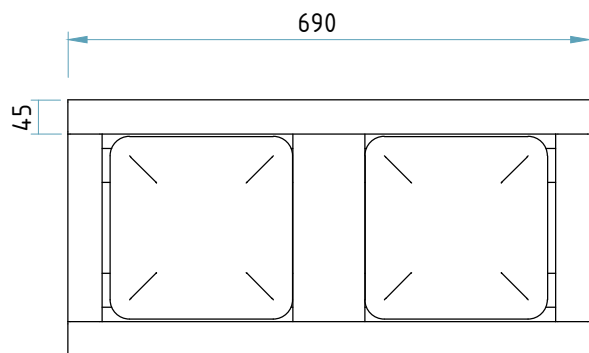
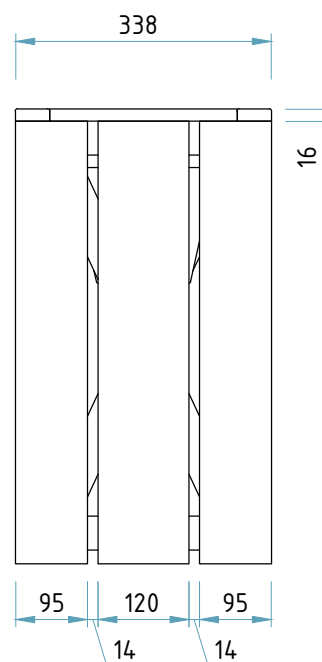
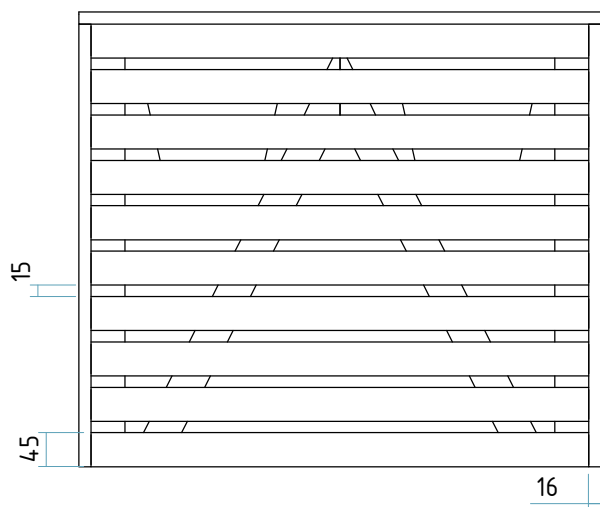

Drawing

Plan, elevations

Scale 1:10

Paper A4

Drawn by 007

Date 23.01.2020

Checked by

Date

Approved by

Date

Page 1

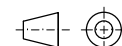

1

2

3

4

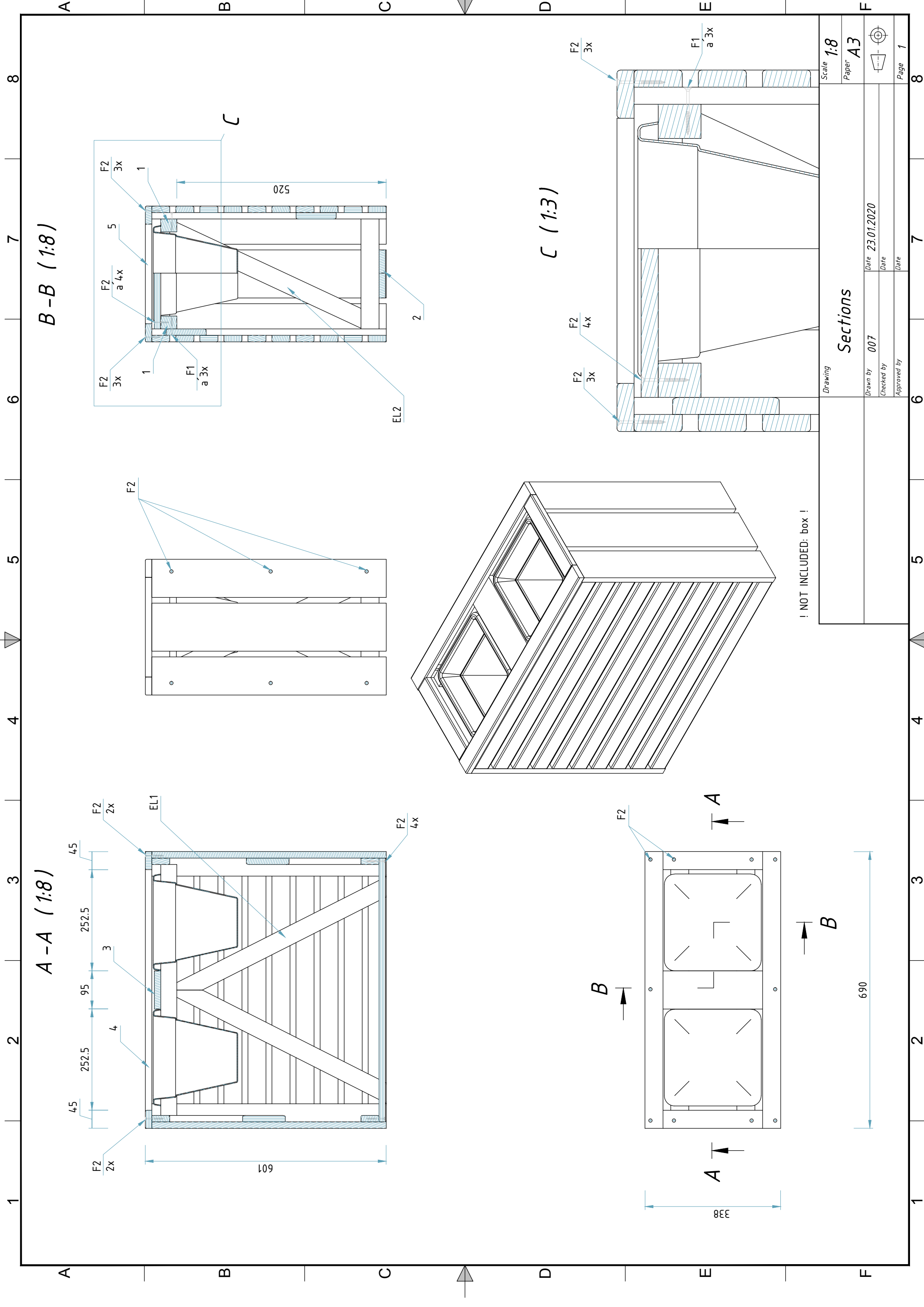

Contact information

Head office:

Dancover A/S
Lyngevej 16A, Nørre Herlev
3400 Hillerød
Denmark

For more information
please visit:

www.dancovershop.com

National contact

Denmark:

denmark@dancover.com

UK:

uk@dancover.com

Germany:

germany@dancover.com

France:

france@dancover.com

Sweden:

sverige@dancover.com

Finland:

suomi@dancover.com

Poland:

polska@dancover.com

Luxembourg:

luxembourg@dancover.com

Portugal:

portugal@dancover.com

Spain:

espana@dancover.com

Italy:

italia@dancover.com

Switzerland:

schweiz@dancover.com

Austria:

austria@dancover.com

Norway:

norge@dancover.com

Nederland:

nederland@dancover.com

Ireland:

ireland@dancover.com

Belgium:

belgique@dancover.com