

DANCOVER[®]

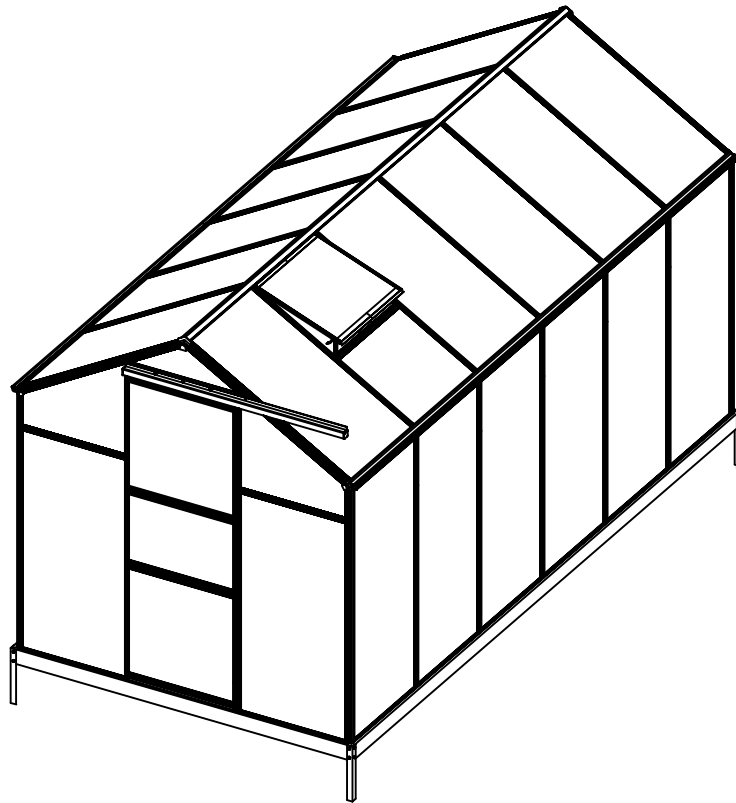

Manual
for
Greenhouse
1,84x3,63x1,93m

Assembly Instructions



PRODUCT SIZE(LxWxH):363X184X193CM
PLEASE READ CAREFULLY BEFORE ASSEMBLY

CONTENTS

1. Base Assembly	Page 1 - 2
2. Parts List	Page 3
3. Roof Vent Assembly	Page 4
4. Door Assembly	Page 5
5. Framework & Glazing Assembly	Page 6 - 26

Safety Warning & Advice

KEEP WORKING AREA CLEAN AND DRY

A cluttered, damp or wet working area may cause injuries.

PREPARE A FLAT AND LEVEL BASE

Make sure your greenhouse is located on a flat and level surface.

DO NOT INSTALL THE GREENHOUSE ON A WINDY DAY OR IN AN AREA SUBJECT TO HIGH WINDS

Although this greenhouse is designed to withstand greater wind loads than many other greenhouses, do not install it in on a windy day or in an area which is subject to high winds. A partially completed greenhouse may be seriously damaged if it is left in this state. It is your responsibility to safely and securely anchor the greenhouse, having regard to wind conditions in your area.

POLYCARBONATE SHEET

Remove approximately 2 inches of film from all sheet edges before installing and remove all film immediately after the construction is completed. Please ensure that the side with the white film faces outwards.

CHECK PARTS BEFORE ASSEMBLY

All parts have been well labelled. Please sort, separate and identify all components before construction and check against the parts list in this manual.

WARNING

Do not install this product when you are tired or distracted from the job at hand. We recommend that you use gloves during assembly.

POWERED SCREWDRIVER RECOMMENDED

This quality greenhouse features self-tapping screws to provide strong joints. As the name suggests, the screws tap their own thread. Driving in self-tapping screws requires more force than conventional screws. A powered screwdriver is therefore recommended.

PART	NO	QTY
└	C	4
┌	A1	2
└	B1	2
🔩	S01	16
	M6X10	
⚙️	M01	16
	M6	
🔩	Z01	36
	M4.2X16	

Base Assembly

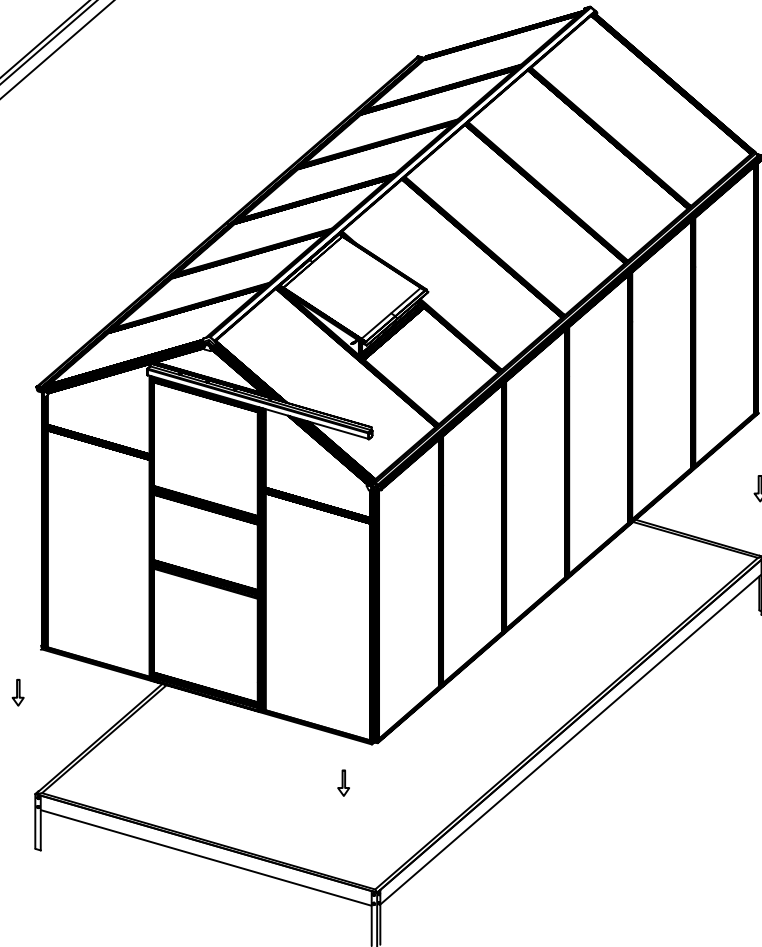
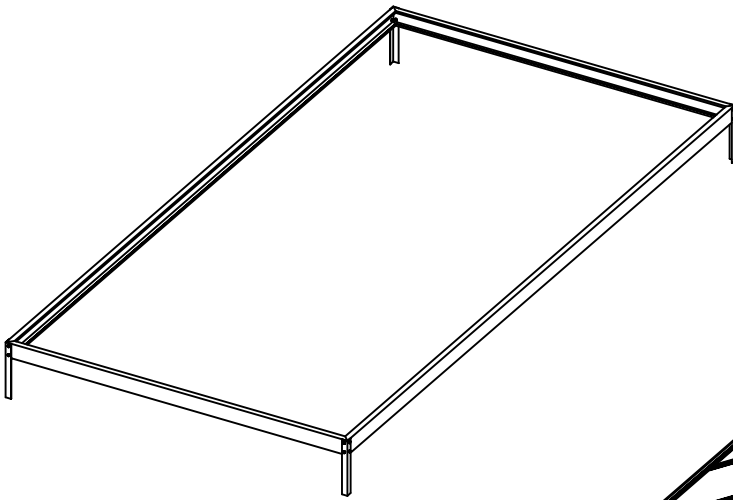
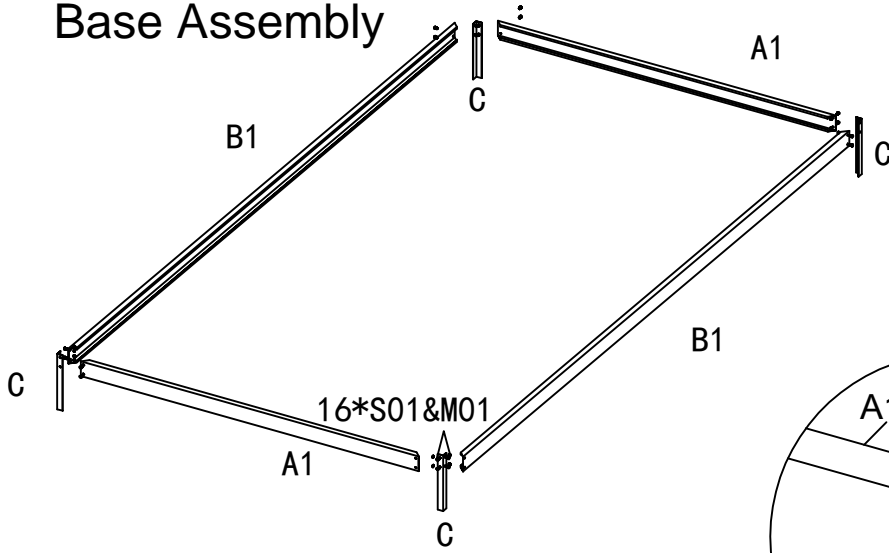



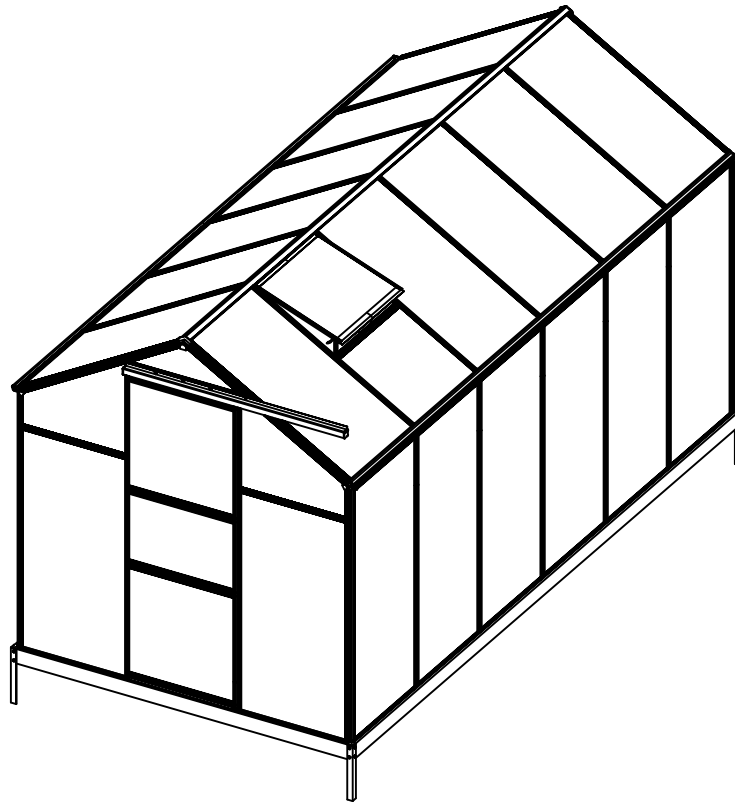



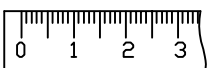
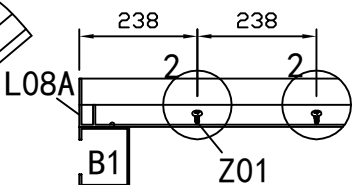
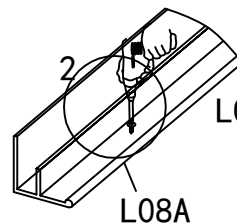
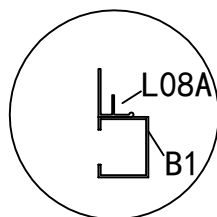
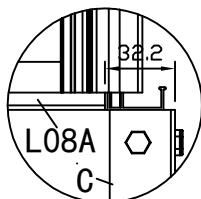
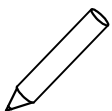
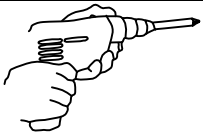
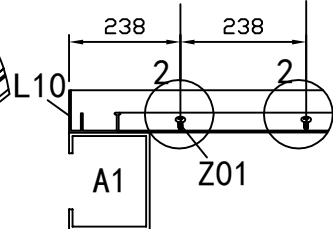
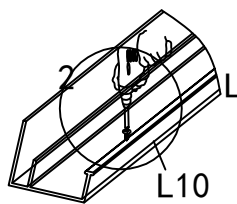
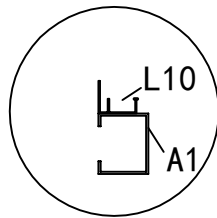
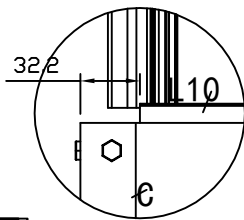
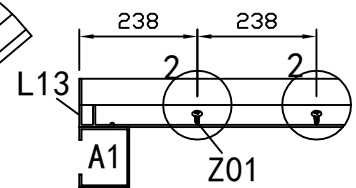
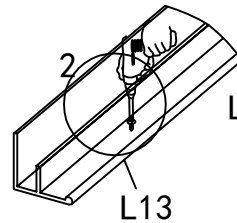
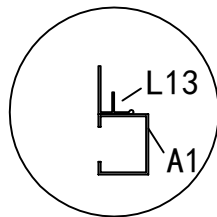
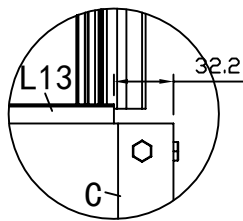

Fixing the greenhouse to the base is recommended. It is best to do this at the end, after the greenhouse has been fully assembled.









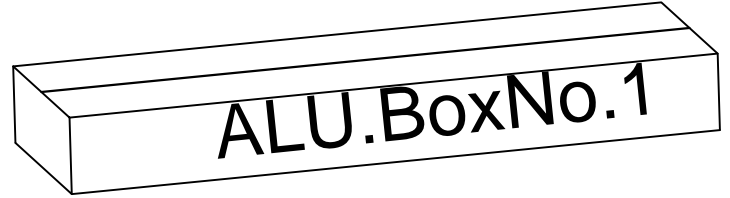

Use a powered screwdriver to fix the self-tapping screws (Z01) through the cills (L08A, L10 and L13) and base plinth (A1 and B1). The screws should be evenly spaced to ensure a neat appearance. The recommended spacing of the screws is 238mm. You can mark the painted surfaces with a pencil.















PART	NO	QTY
	L06	1
	L07	2
	L08A	2
	L09	2
	L12A	4













PART	NO	QTY
	C	4
	A1	2
	B1	2









PART	NO	QTY
	L01A	2
	L01B	2
	L03B	2
	L04A	1
	L04B	1
	L05B	2
	L10	1
	L11	1





PART	NO	QTY
	L01A	2
	L01B	2
	L03B	3
	L04A	1
	L04B	1
	L05A	1
	L13	1

PART	NO	QTY
	L02A	10
	L02B	8
	L02C	1
	L02D	1
	L03B	1
	L14	1





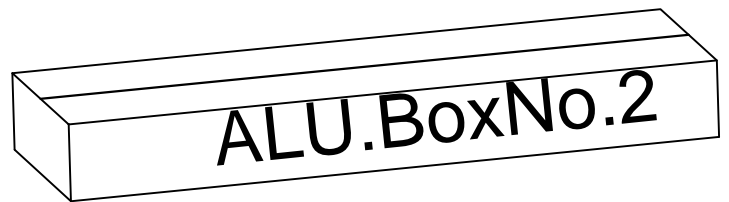

PART	NO	QTY
	W01	6
	W06	1
	W08	1
	J01	2
	J02R	2
	J02L	2
	J03	2
	S01 M6X10	43+2
	M01 M6	43+2
	S02 M4X10	2
	S02 M4X10	2
	Z01 M4.2X16	177+7

PART	NO	QTY
	S01 M6X10	16
	M01 M6	16
	Z01 M4.2X16	36

PART	NO	QTY
	L19	2
	L20	1
	L21	1







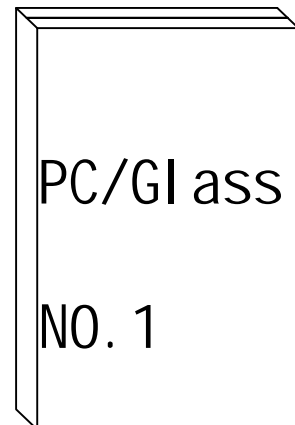

PART	NO	QTY
	L15	1
	L16	2
	L17	1
	L18	2



PART	NO	QTY
	Y1	2
	Y2	5
	Y3	1
	Y4	2
	Y5	1
	Y6	12
	Y7	11

PART	NO	QTY
	Y9	1
	Y10	1
	Y11	1
	Y12	2







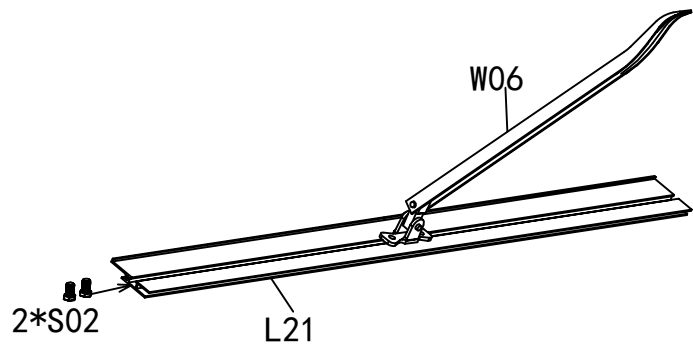

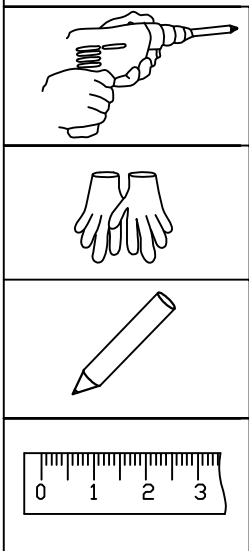
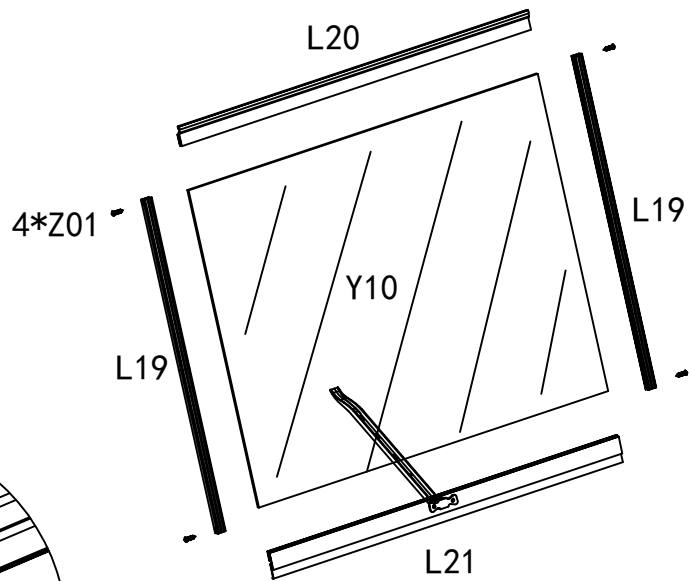
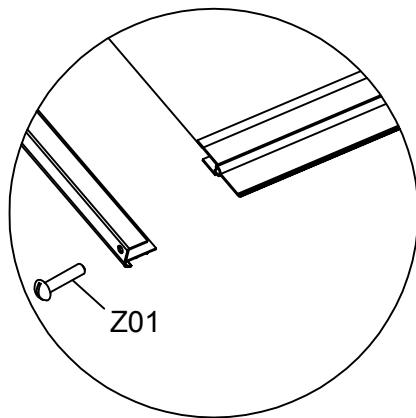
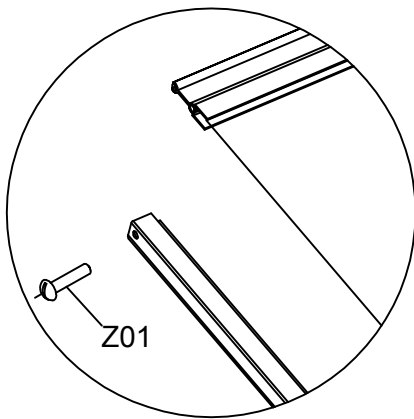

PART	NO	QTY
	L19	2
	L20	1
	L21	1
	W06	1
	Z01 M4.2X16	4
	Y10	1
	S02 M4X10	2
	M02 M4	2

Vent Assembly









Slide 2 bolts (S02) into the bolt channel (L21) and fix the handle (W06) in the middle

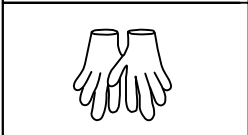
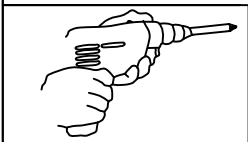
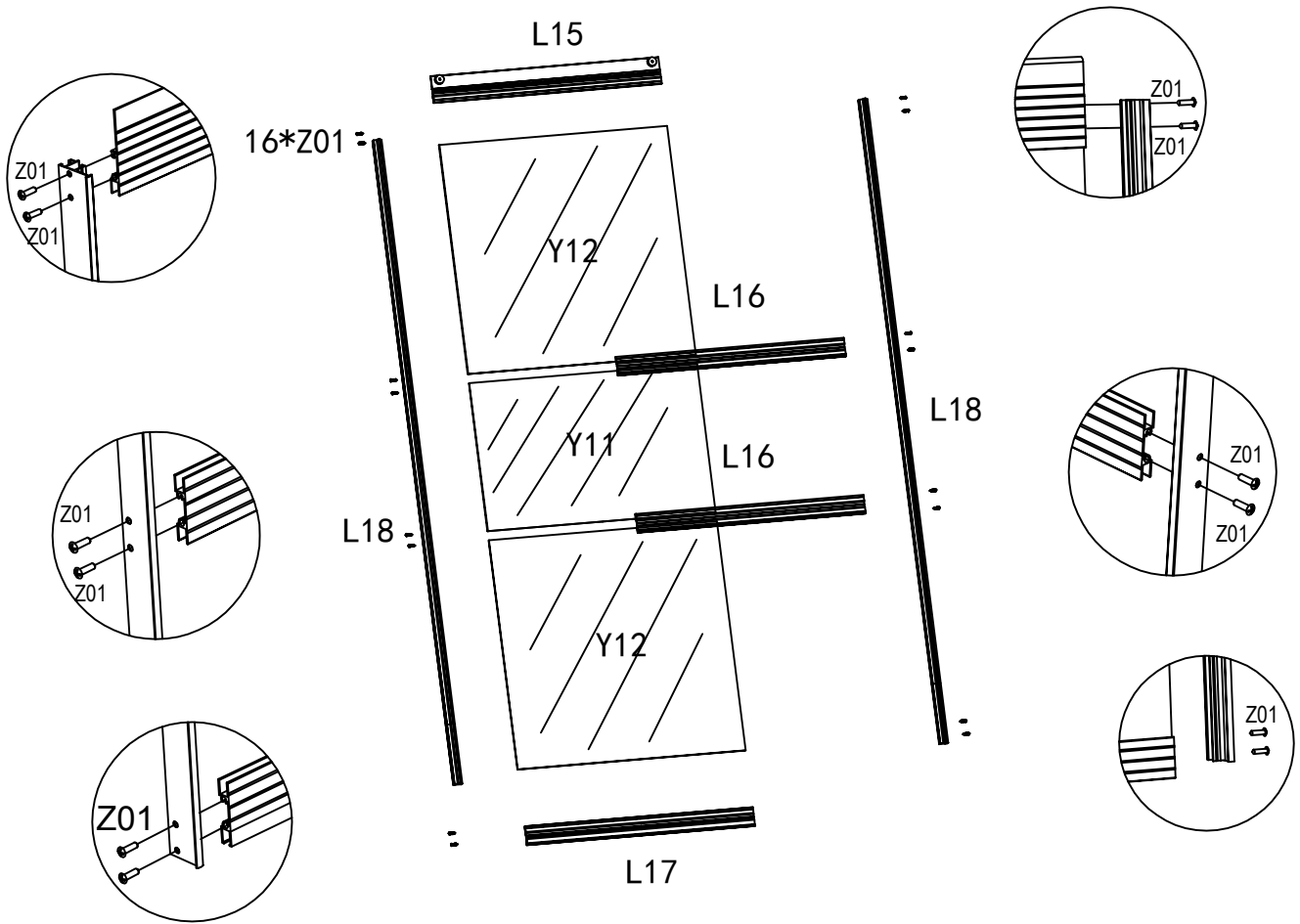

PART	NO	QTY
	L15	1
	L16	2
	L17	1
	L18	2
	Z01 M4.2X16	16
	Y11	1
	Y12	2

Door Assembly





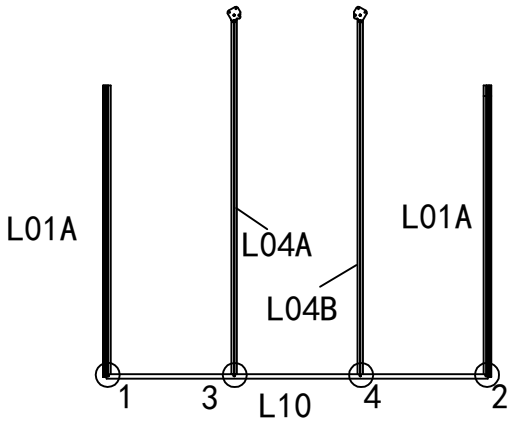
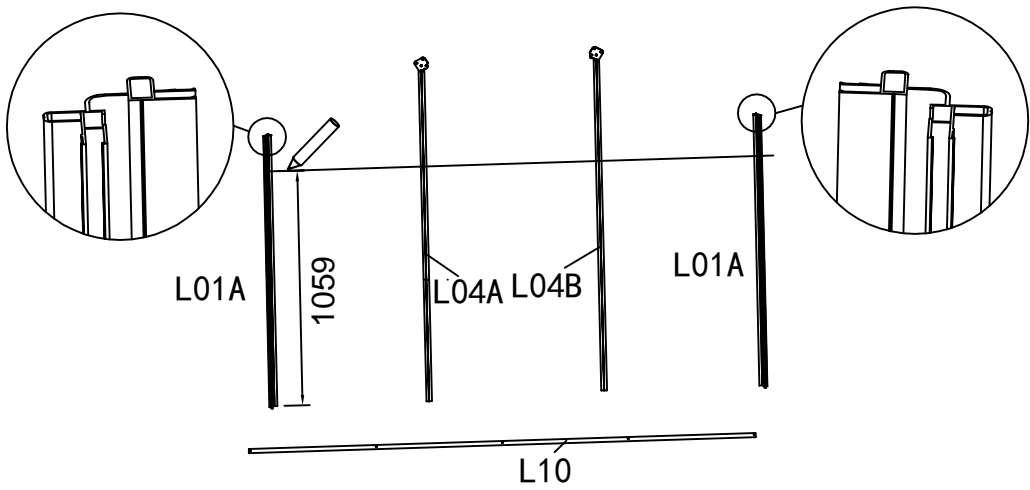

PART	NO	QTY
	L04A	1
	L04B	1
	L01A	2
	L10	1
	Z01 M4.2X16	4

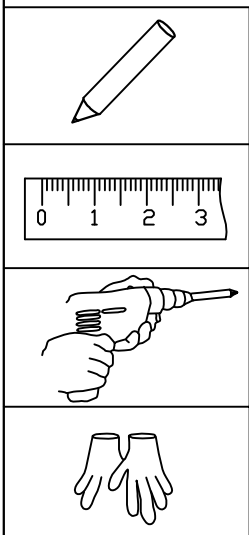
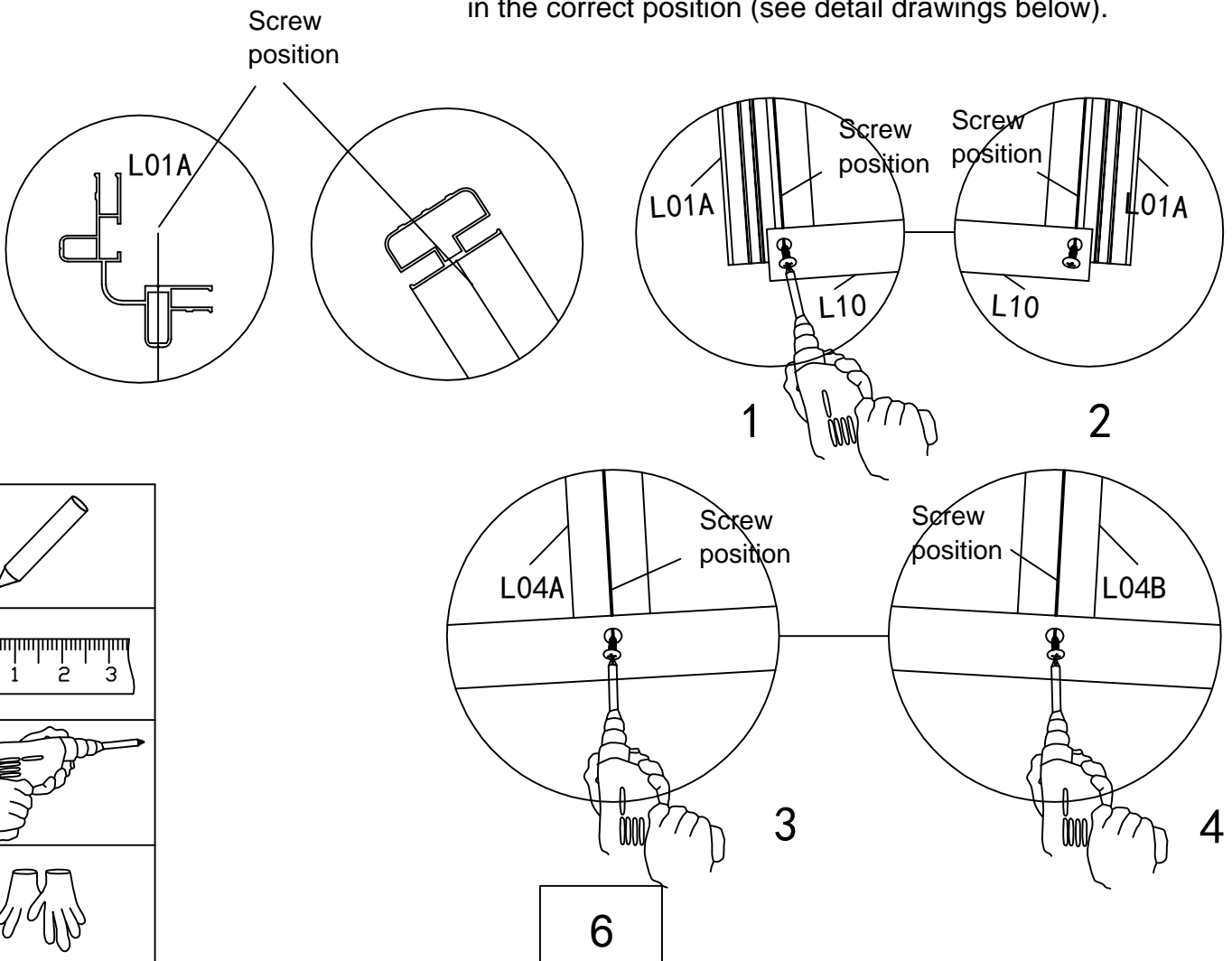

1. Lay out the glazing bars (2 x L01A, L04A and L04B) and the cill (L10). Ensure that the cill upstand is on the inside and that L01A is the correct way round.
2. Make a pencil mark on the glazing bars (2 x L01A, L04A and L04B) at a height of 1059mm from the bottom. This will help later when fitting part L05B.
3. Fix the glazing bars (2 x L01A, L04A and L04B) to the cill (L10) with the self-tapping screws (Z01) using a powered screwdriver. The inside of the glazing bars feature guide lines which indicate the correct screw positions (see detail drawings below). Be careful to ensure that the screws are in the correct position (see detail drawings below).





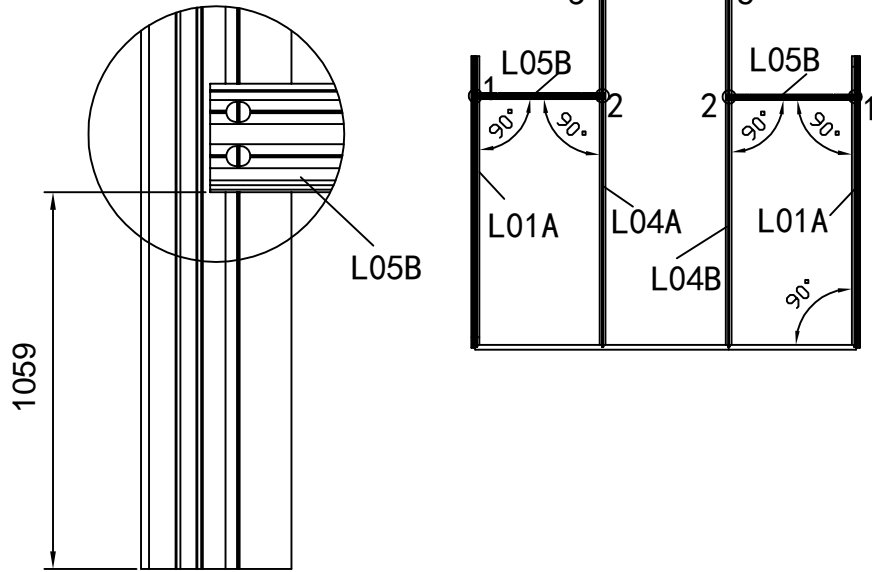

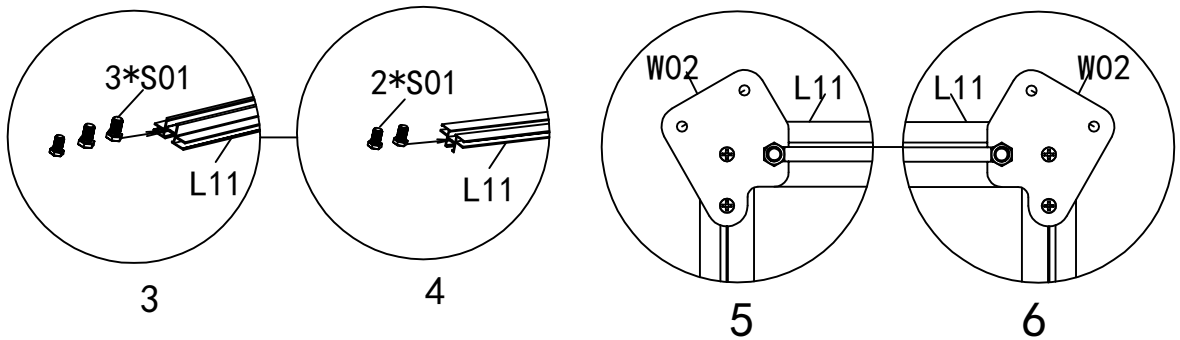
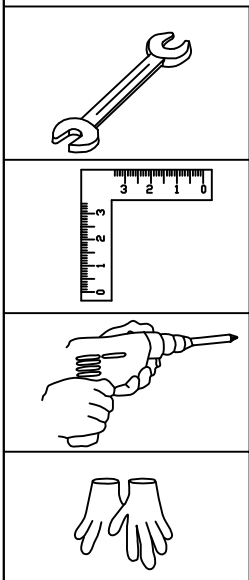
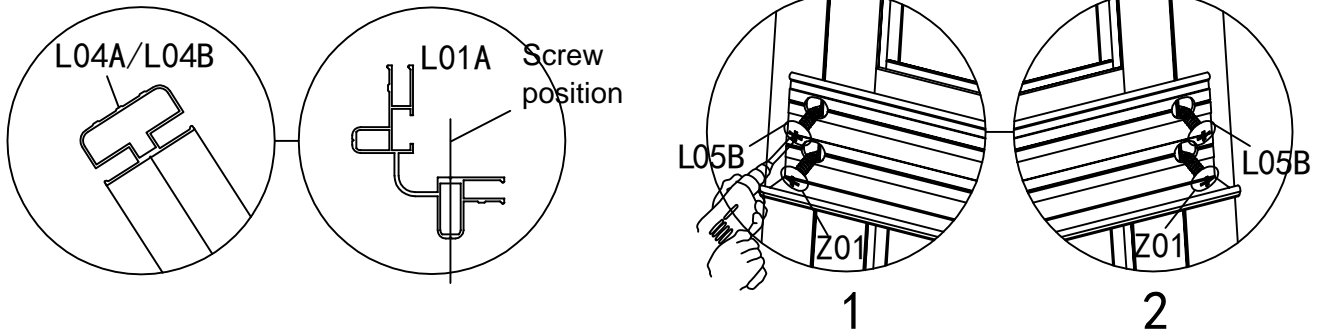

PART	NO	QTY
	L05B	2
	Z01 M4.2X16	8
	L11	1
	S01 M6X10	5
	M01 M6	2



1. Fix 1 x L05B to L01A and L04A and 1 x L05B to L04B and L01A with the self-tapping screws (Z01) using a powered screwdriver. Ensure that L05B is fixed at a right angle (90 degrees) to the glazing bars (2 x L01A, L04A and L04B).
2. Slide 2 bolts (S01) into the inside L11 bolt channel and fix L11 to L04A and L04B (see Figure 4, Figure 5 and Figure 6). Slide 3 bolts (S01) into the external L11 bolt channel (see Figure 3). This will help later when fitting part L14.
3. Part W02 is factory fitted to glazing bars L04A and L04B.





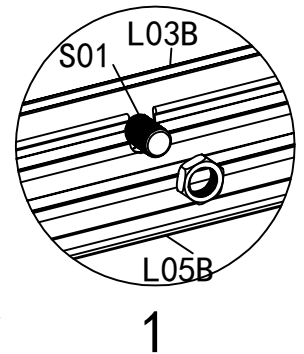
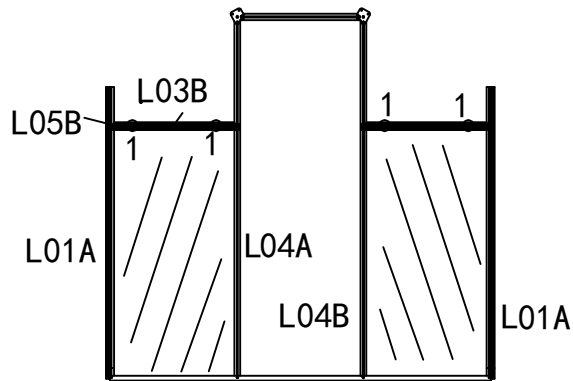
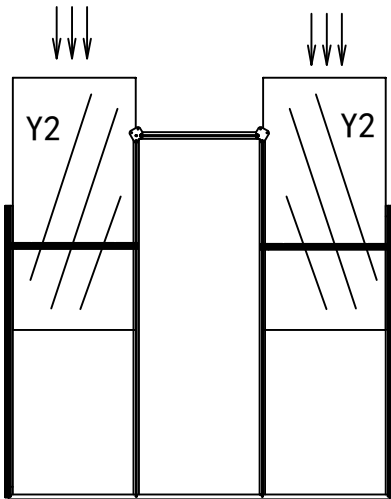
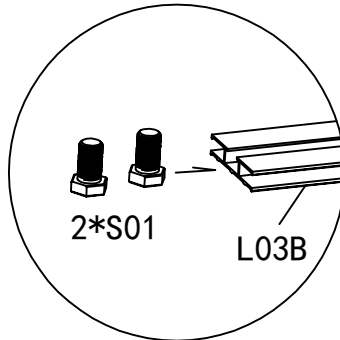

7

PART	NO	QTY
	L03B	2
	Y2	2
	Y1	1
	Y4	1
	Y5	1
	S01	4
	M6X10	
	M01	4
	M6	

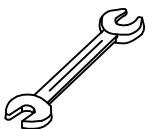
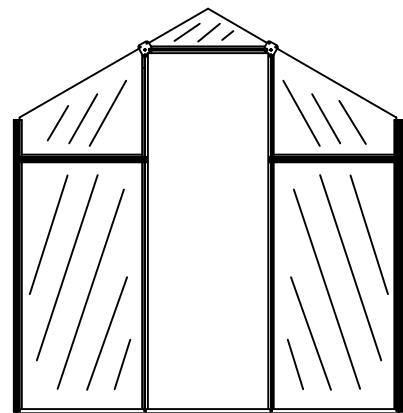
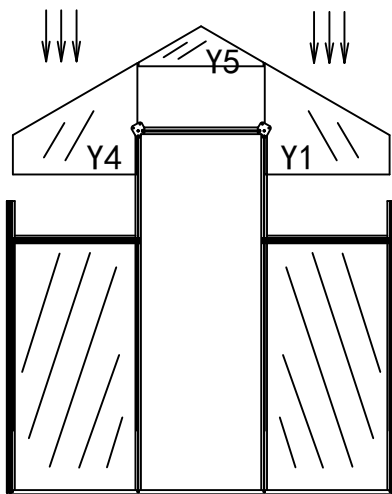







1. Slide the lower glazing panels (Y2) into position.
2. Slide 2 bolts (S01) into the inside L03B bolt channel and fix L03B to L05B.
3. Slide the higher glazing panels (Y1, Y4 and Y5) into position.

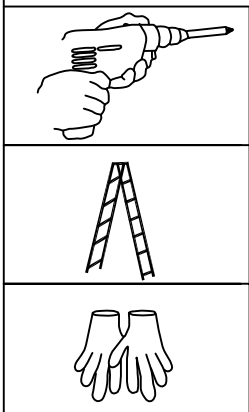
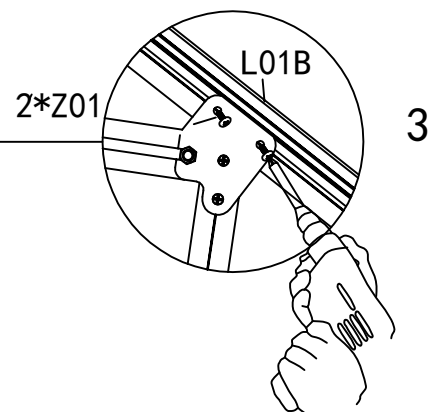
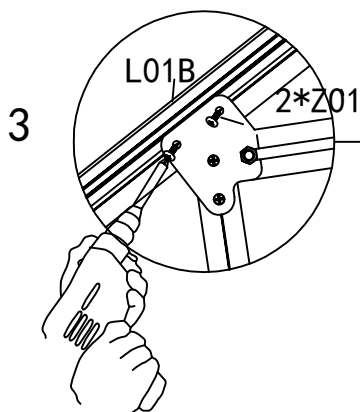
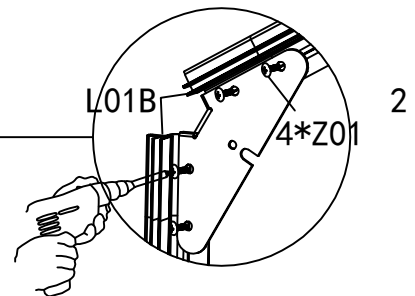
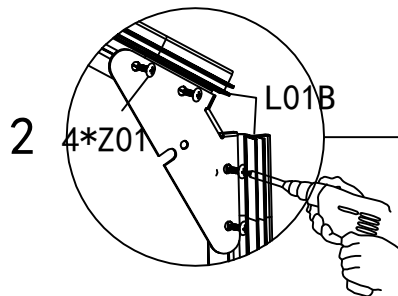
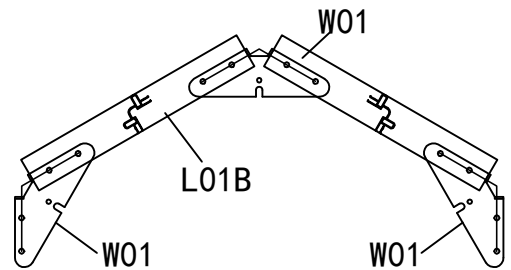
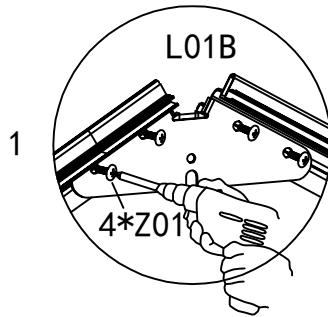
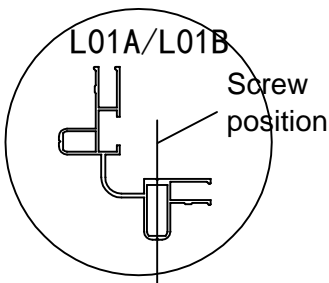
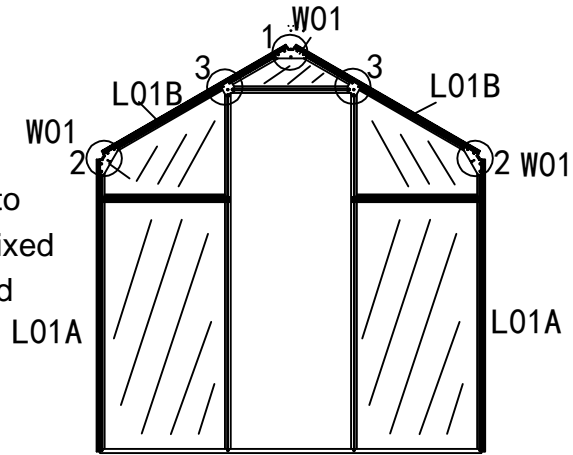

PART	NO	QTY
	L01B	2
	Z01 M4.2X16	16
	W01	3

Fix 1 x L01B to L01A and L04A and 1 x L01B to L04B and L01A using the W01 angled plates fixed with self-tapping screws (Z01) using a powered screwdriver. The inside of the glazing bars L01A feature guide lines which indicate the correct screw positions (see detail drawings below). Be careful to ensure that the screws are in the correct position (see detail drawings below).



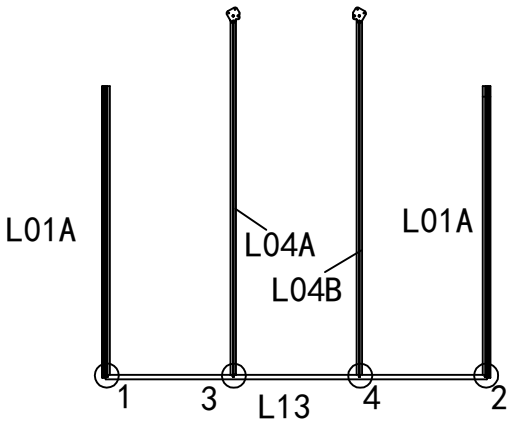
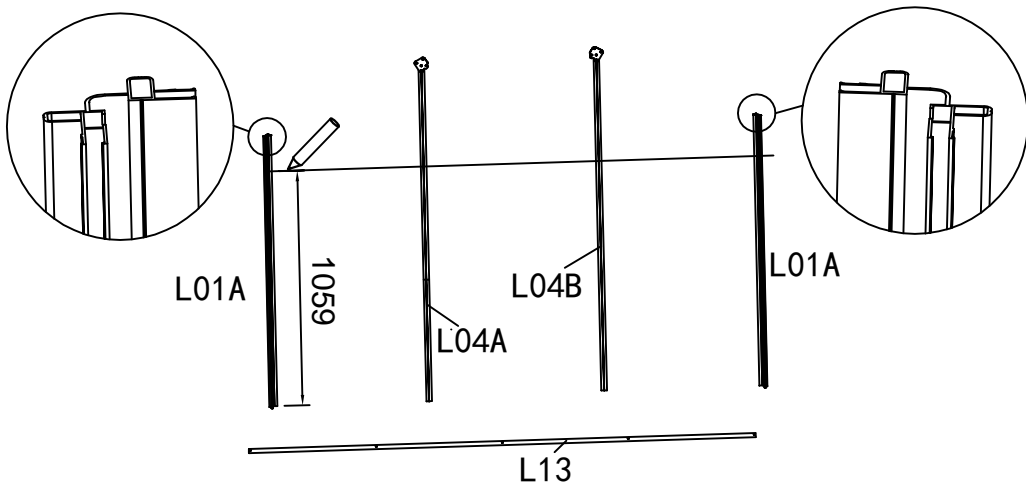

PART	NO	QTY
	L04A	1
	L04B	1
	L01A	2
	L13	1
	Z01 M4.2X16	4

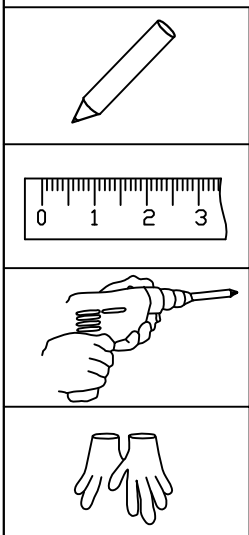
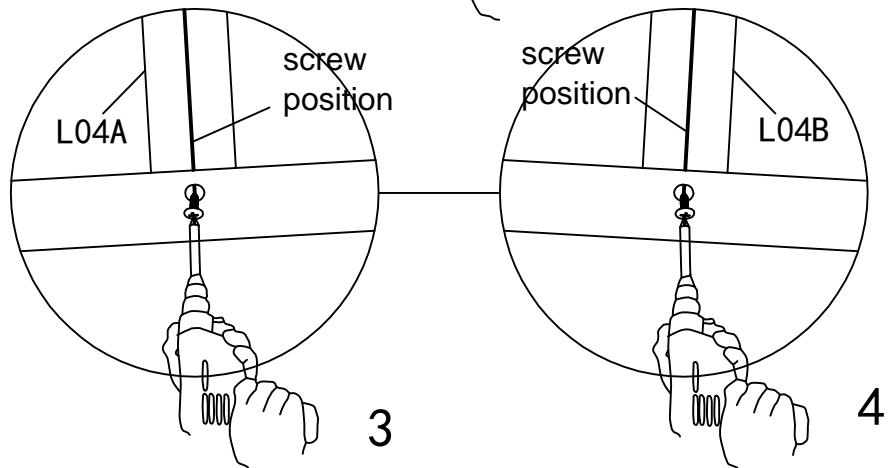
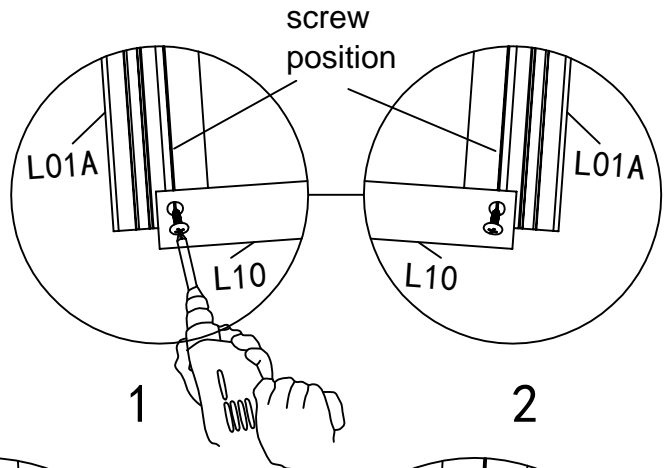
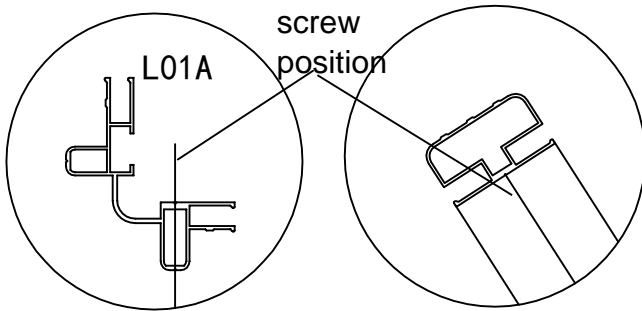

1. Lay out the glazing bars (2 x L01A, L04A and L04B) and the cill (L13). Ensure that the cill upstand is on the inside and that L01A is the correct way round.
2. Make a pencil mark on the glazing bars (2 x L01A, L04A and L04B) at a height of 1059mm from the bottom. This will help later when fitting part L05A.
3. Fix the glazing bars (2 x L01A, L04A and L04B) to the cill (L13) with the self-tapping screws (Z01) using a powered screwdriver. The inside of the glazing bars feature guide lines which indicate the correct screw positions (see detail drawings below). Be careful to ensure that the screws are in the correct position (see detail drawings below).





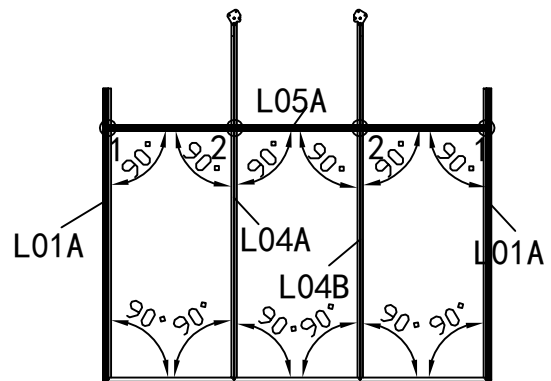
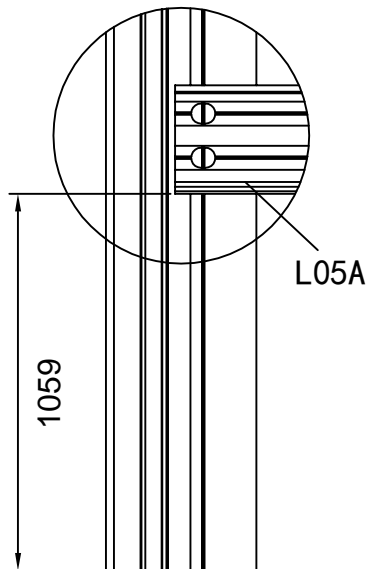

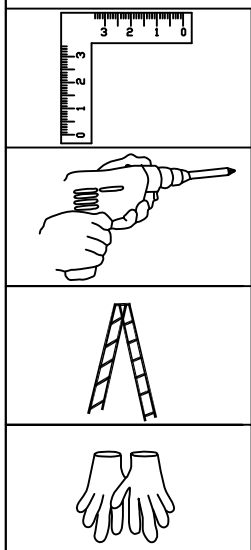
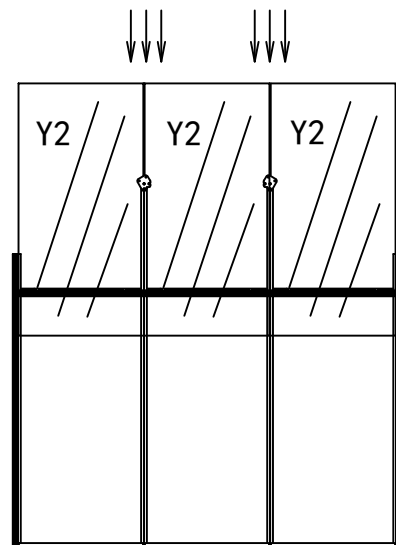
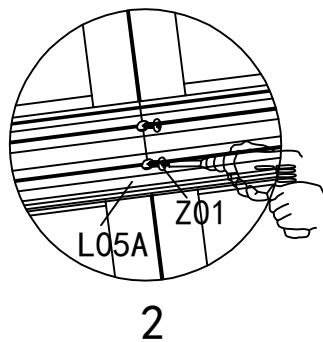
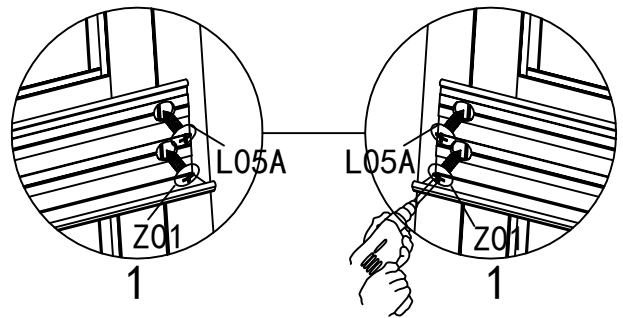
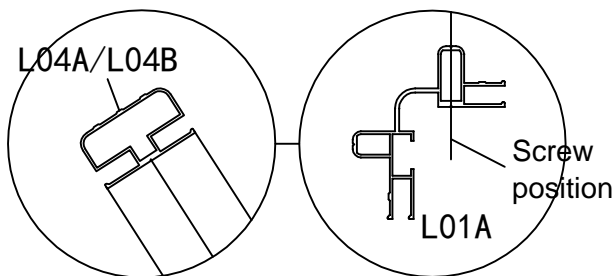

PART	NO	QTY
	L05A	1
	Z01 M4.2X16	8
	Y2	3



1. Fix the horizontal brace (L05A) to the glazing bars (2 x L01A, L04A and L04B) with the self-tapping screws (Z01) using a powered screwdriver. Ensure that L05A is fixed at a right angle (90 degrees) to the glazing bars.
2. Slide the lower glazing panels (Y2) into position.



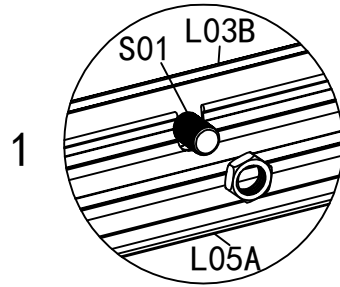
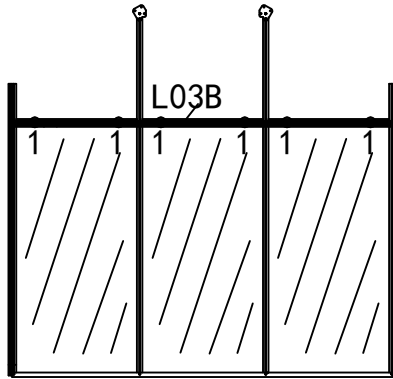
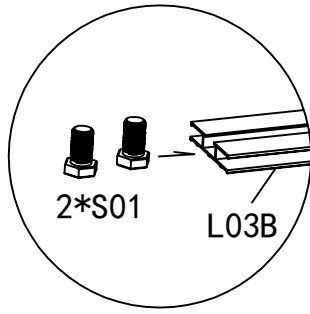

PART	NO	QTY
	L03B	3
	Y1	1
	Y4	1
	Y3	1
	S01 M6X10	6
	M01 M6	6

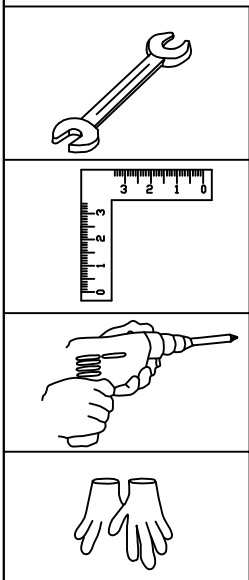
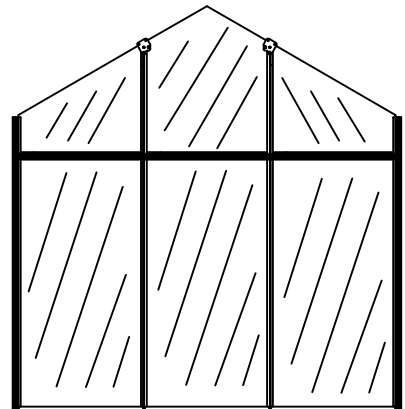
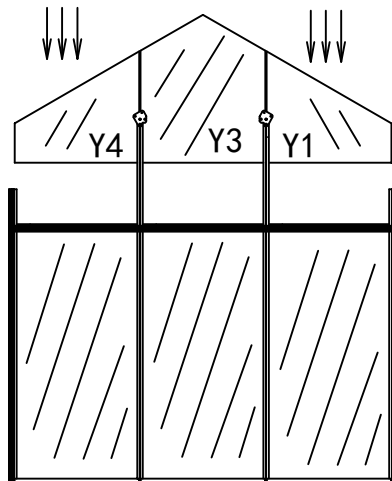

1. Slide 2 bolts (S01) into the inside L03B bolt channel and fix L03B to L05A.
2. Slide the higher glazing panels (Y1, Y3 and Y4) into position.





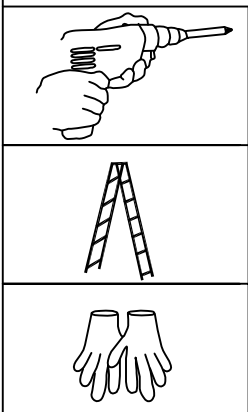
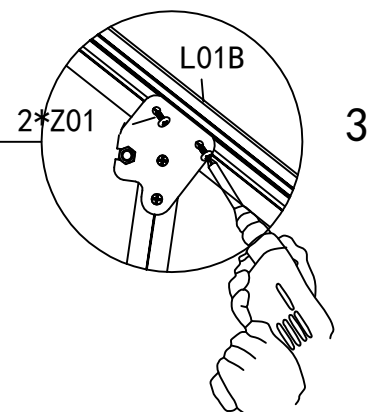
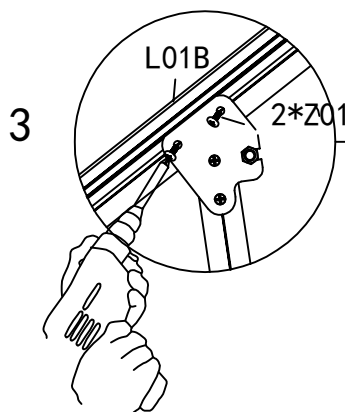
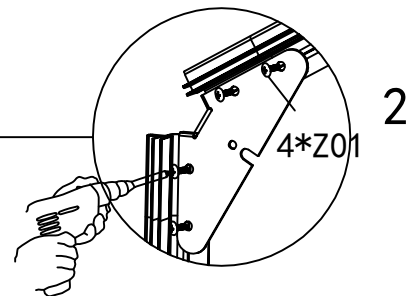
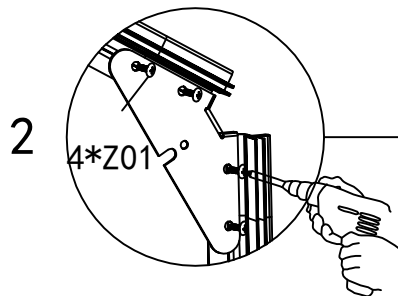
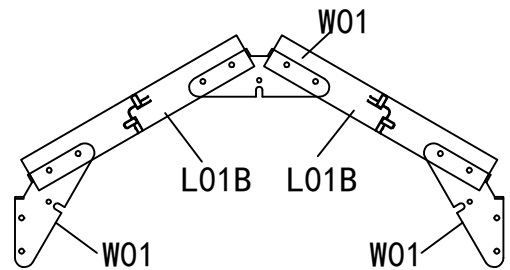
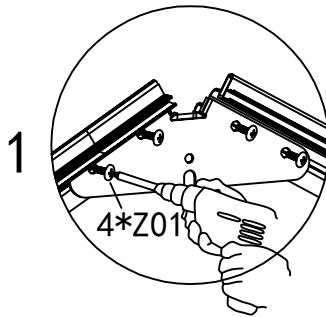
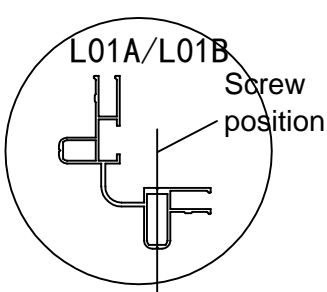
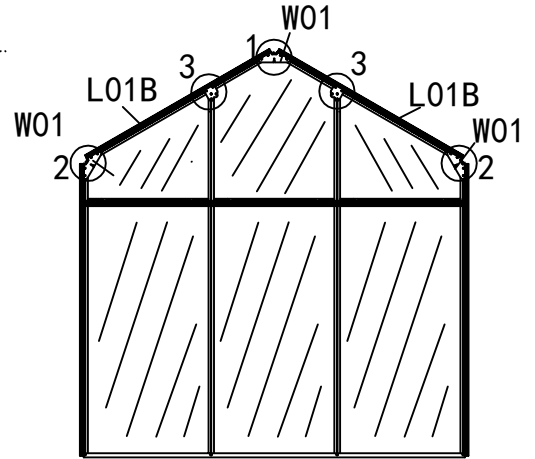

PART	NO	QTY
	L01B	2
	Z01 M4.2X16	16
	W01	3

Rear Wall

1. Fix 1 x L01B to L01A and L04A and 1 x L01B to L04B and L01A using the W01 angled plates fixed with self-tapping screws (Z01) using a powered screwdriver. The inside of the glazing bars feature guide lines which indicate the correct screw positions (see detail drawings below). Be careful to ensure that the screws are in the correct position (see detail drawings below).
2. Part W02 is factory fitted to glazing bars L04A and L04B.



PART	NO	QTY
	L08A	2
	L07	2
	S01	24
	M6X10	
	M01	12
	M6	

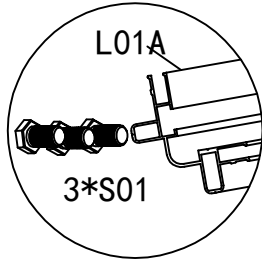

1. Slide 3 bolts (S01) into each L01A bolt channel (2 to be used later).
2. Bolt 2 x L08A cills to L01A using S01 bolts

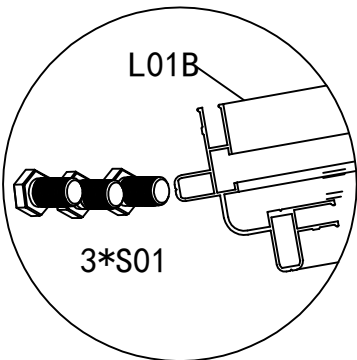
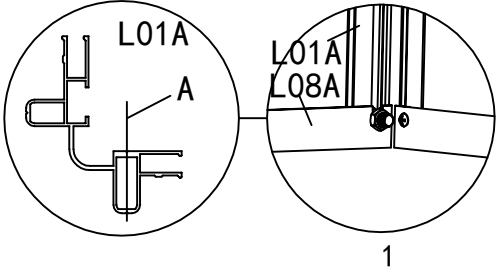
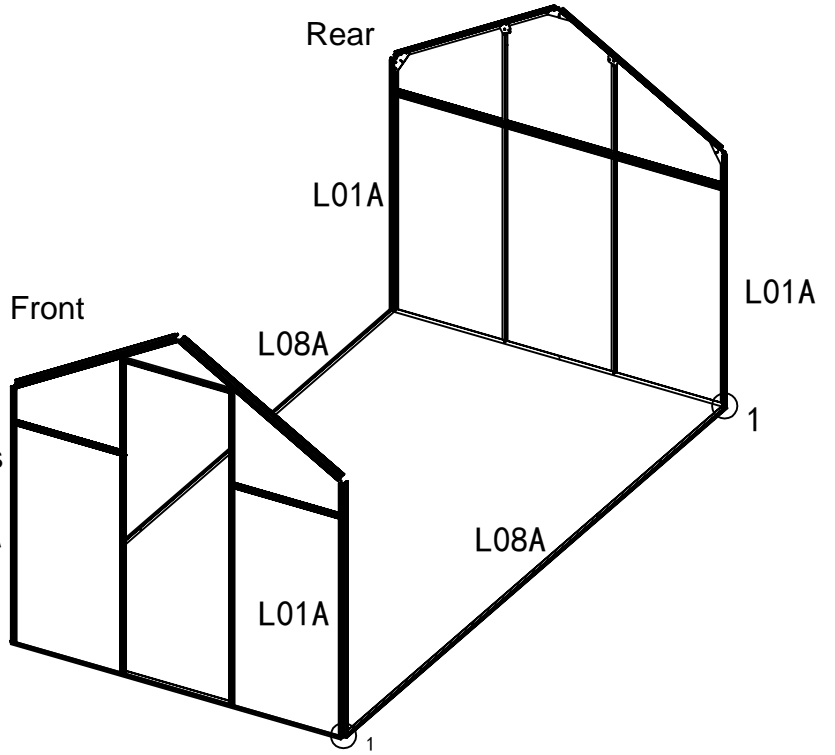

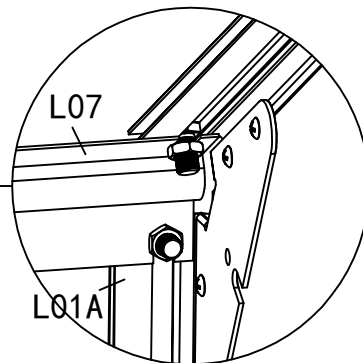
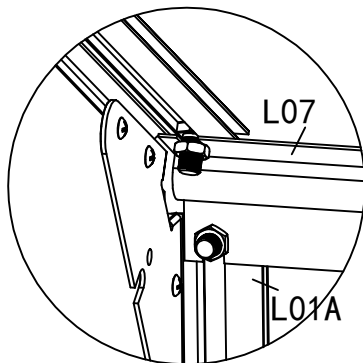
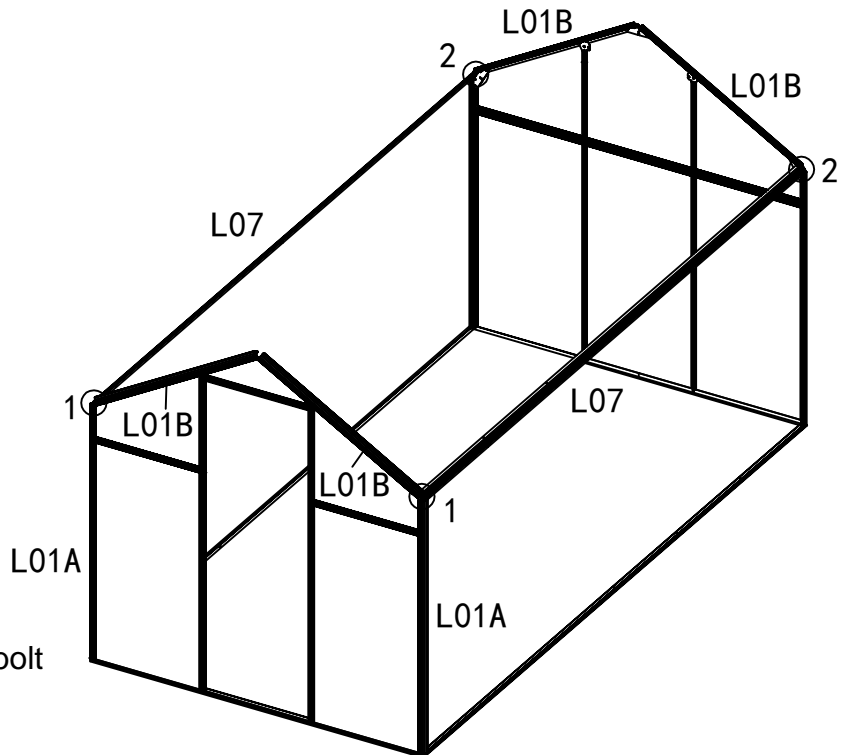

Slide 3 bolts (S01) into each L01B bolt channel (2 to be used later).

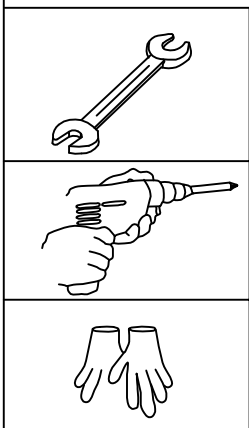

Bolt 2 x L07 eaves to L01A and L01B using S01 bolts



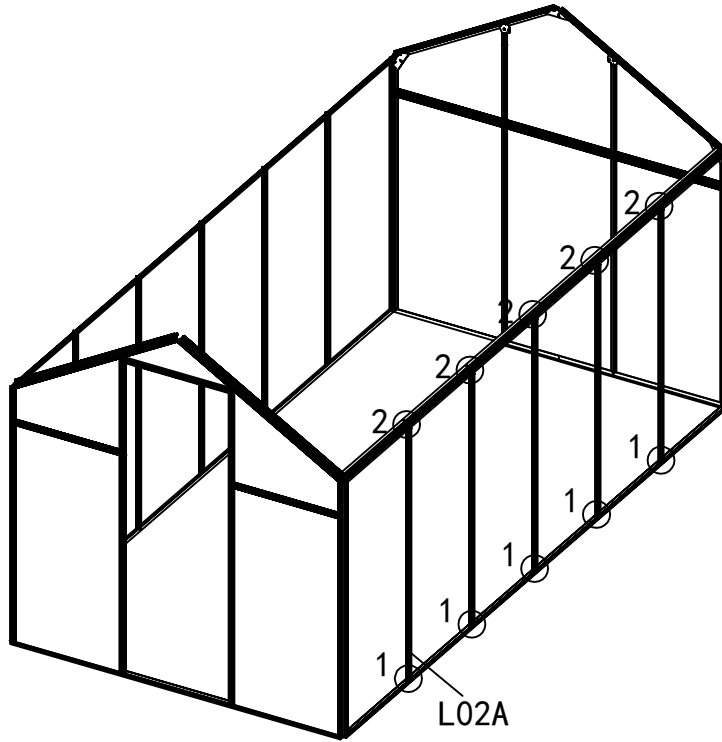

PART	NO	QTY
	L02A	10
	Z01 M4.2X16	20

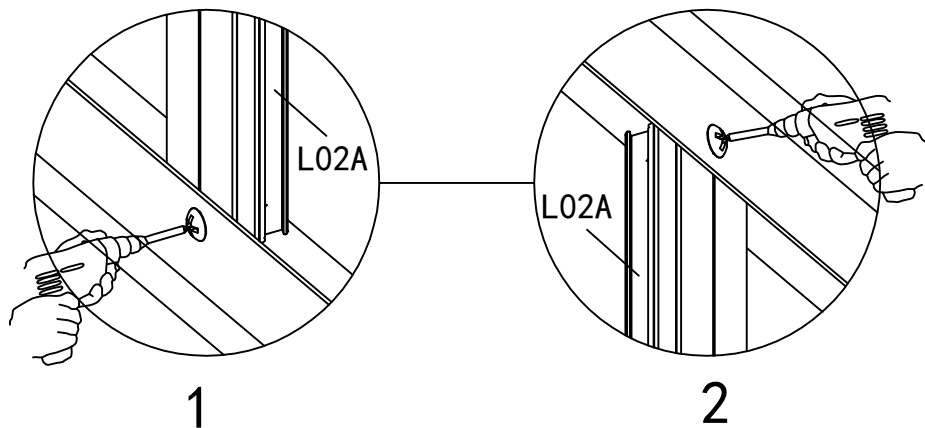
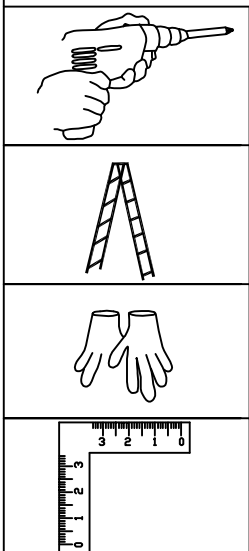
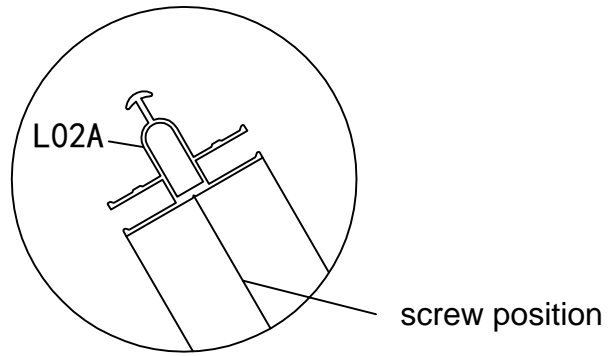

Fix the glazing bars (L02A) to the cills (L08A) and the eaves (L07) with the self-tapping screws (Z01) using a powered screwdriver. The inside of the glazing bars feature guide lines which indicate the correct screw positions (see detail drawings below). Be careful to ensure that the screws are in the correct position (see detail drawings below).



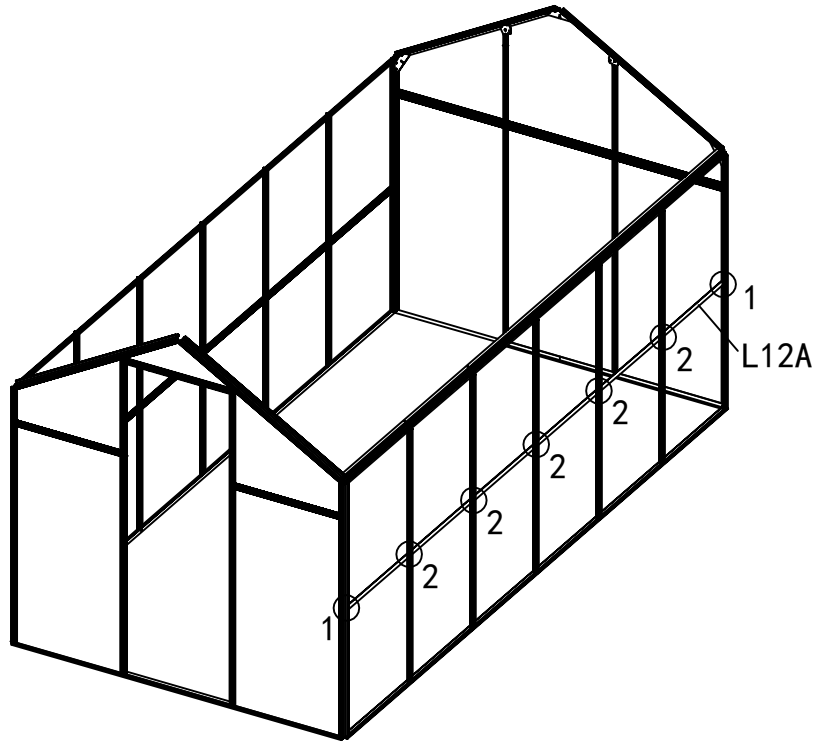

PART	NO	QTY
	L12A	2
	Z01 M4.2X16	20
	M01 M6	4

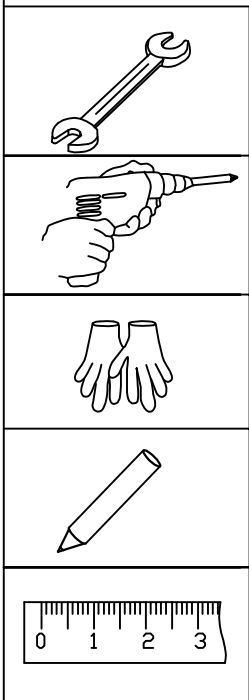
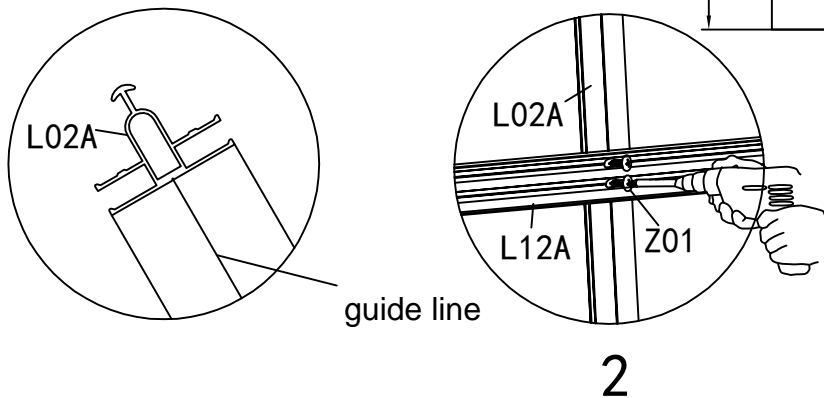
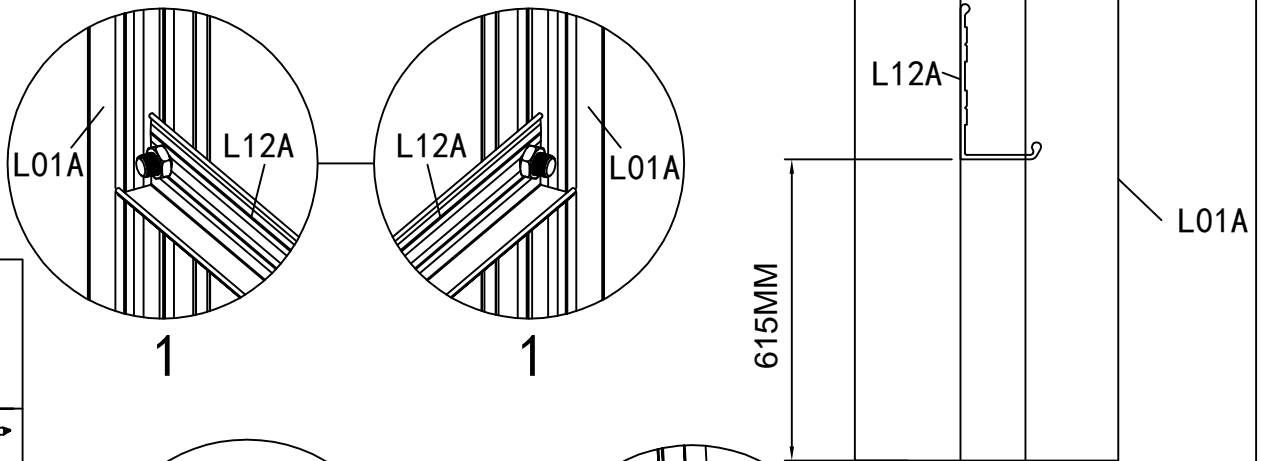

Fix 2 x L12A to the glazing bars at a height of 615mm. Bolt L12A to L01A using the extra S01 bolt placed in the bolt channel earlier. Fix the L12A to L02A with the self-tapping screws (Z01) using a powered screwdriver. Ensure that L12A is fixed at a right angle (90 degrees) to the glazing bars. Please note, if extra bolts were not placed in the bolt channel earlier L01A must be unbolting at one end and moved enough to squeeze the bolts in.



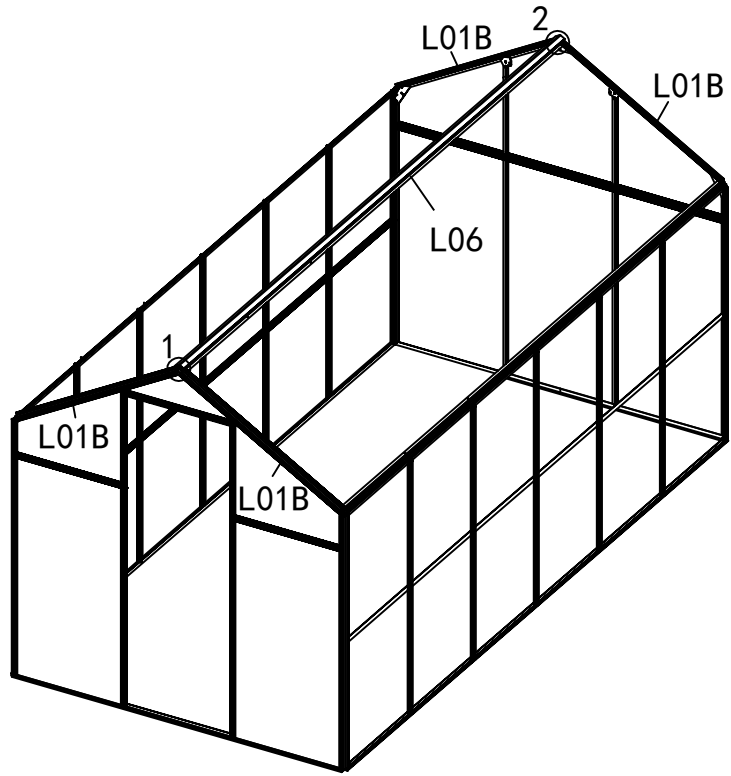

PART	NO	QTY
	L06	1
	M01	4
	M6	

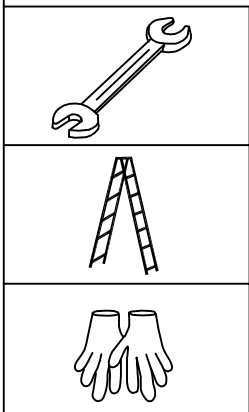
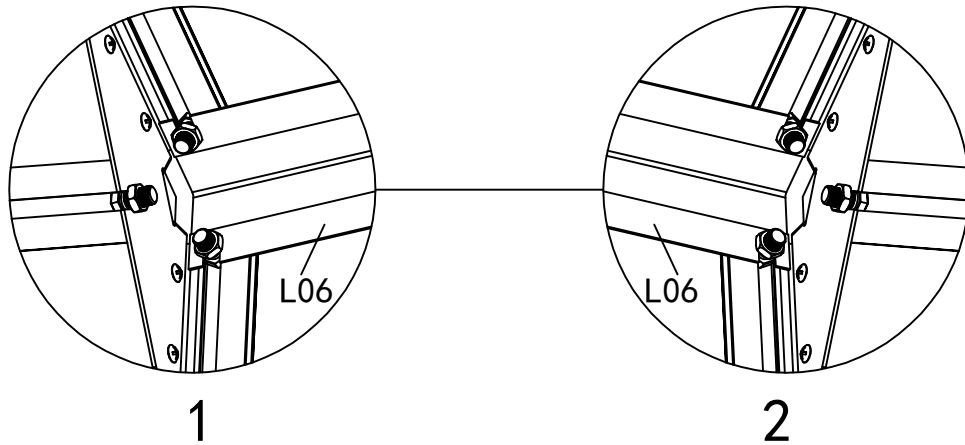

Bolt the ridge (L06) to 4 x L01B using the extra S01 bolts placed in the bolt channels earlier. Please note, if extra bolts were not placed in the bolt channel earlier L01B must be unbolted at one end and moved enough to squeeze the bolts in.



PART	NO	QTY
	L02B	8
	L02D	1
	Z01 M4.2X16	18

Fix the glazing bars (L02B and L02D) to the eaves (L07) and the ridge (L06) with the self-tapping screws (Z01) using a powered screwdriver. The inside of the glazing bars feature guide lines which indicate the correct screw positions (see detail drawings below). Be careful to ensure that the screws are in the correct position (see detail drawings below).

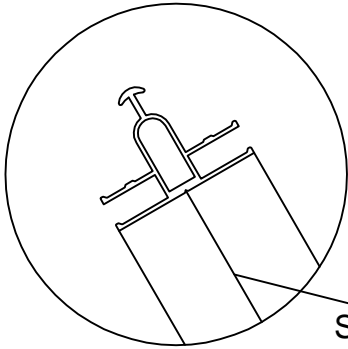
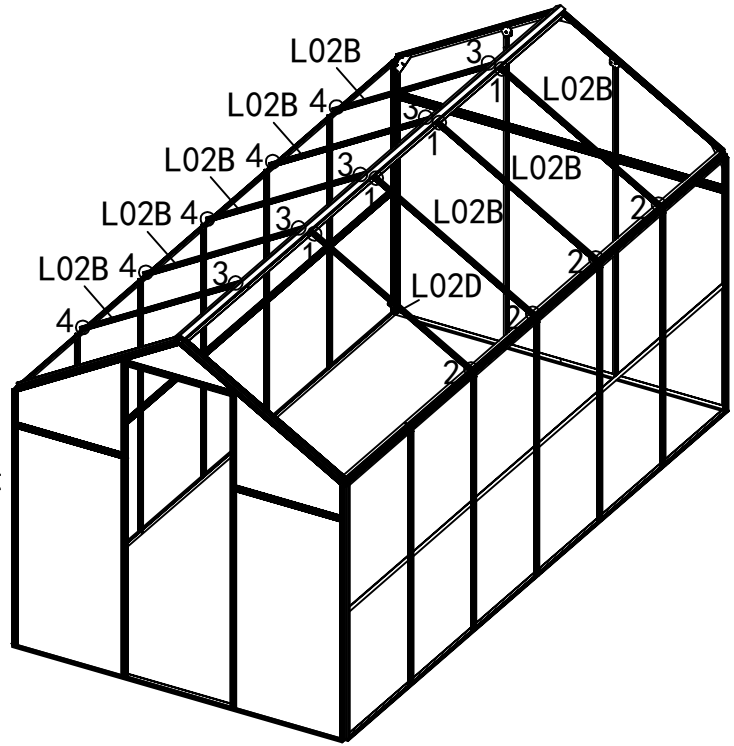

Screw position

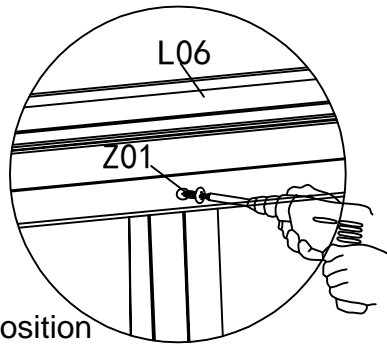

1

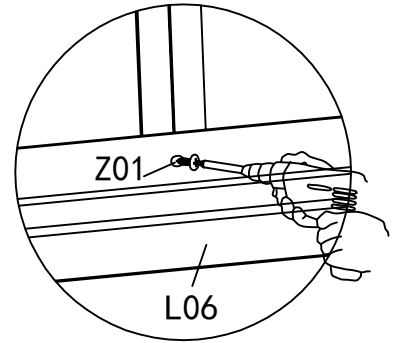

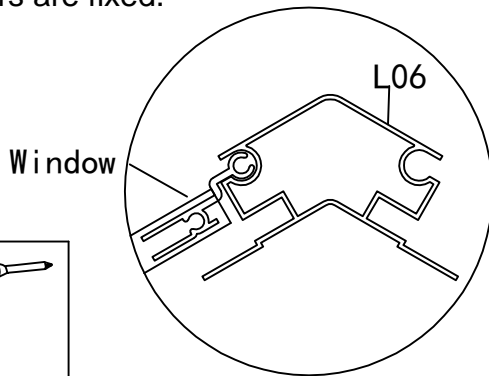

2

Slide the roof vents into position along the ridge (L06). The top of the roof vent locates in a groove in the ridge (L06). Please note that the glazing bars obstruct the passage of the roof vents, which must be in position before the last of the glazing bars are fixed.

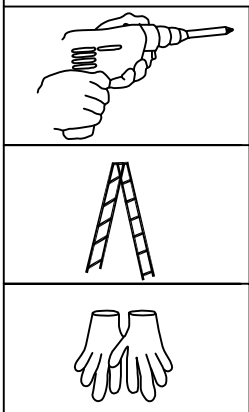
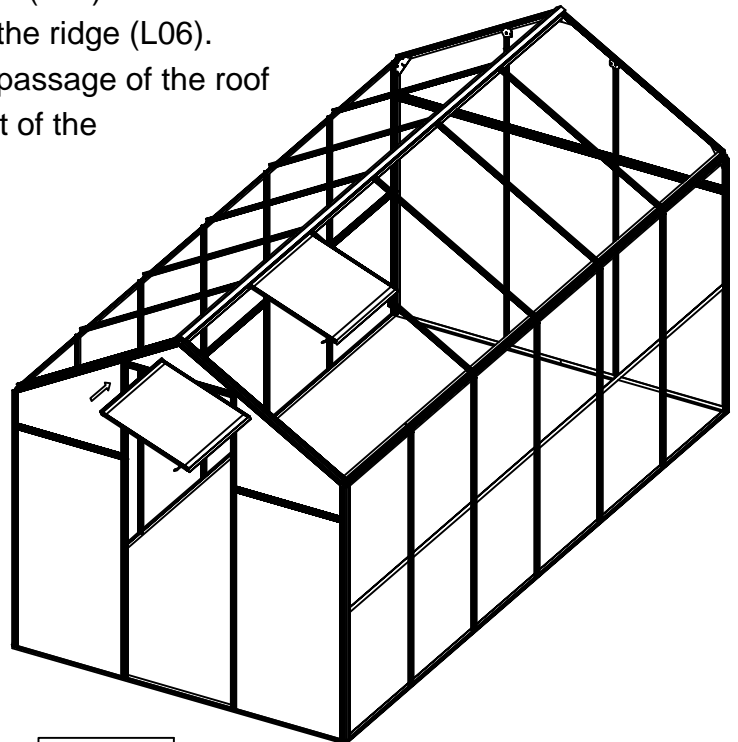

Window





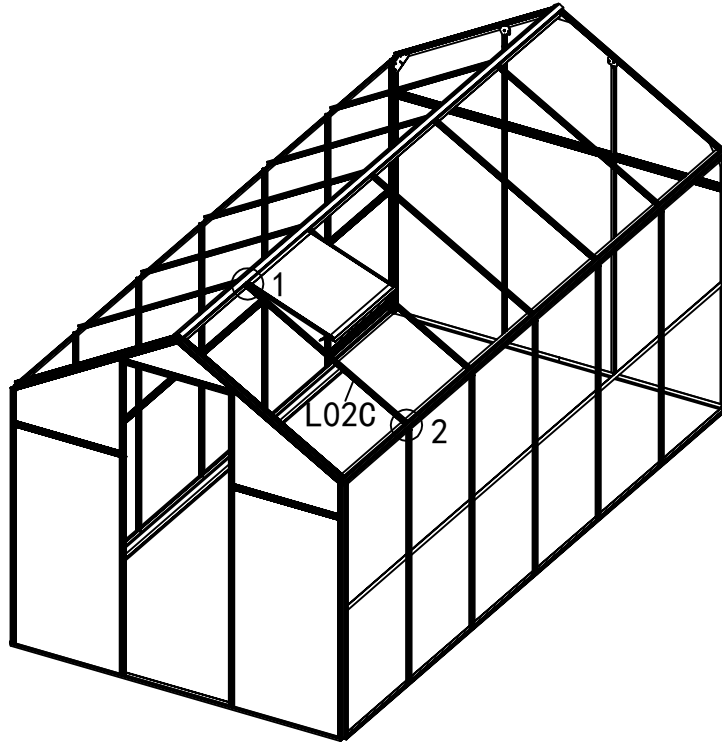

PART	NO	QTY
	L02C	1
	Z01 M4.2X16	2

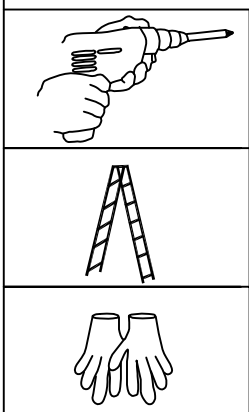
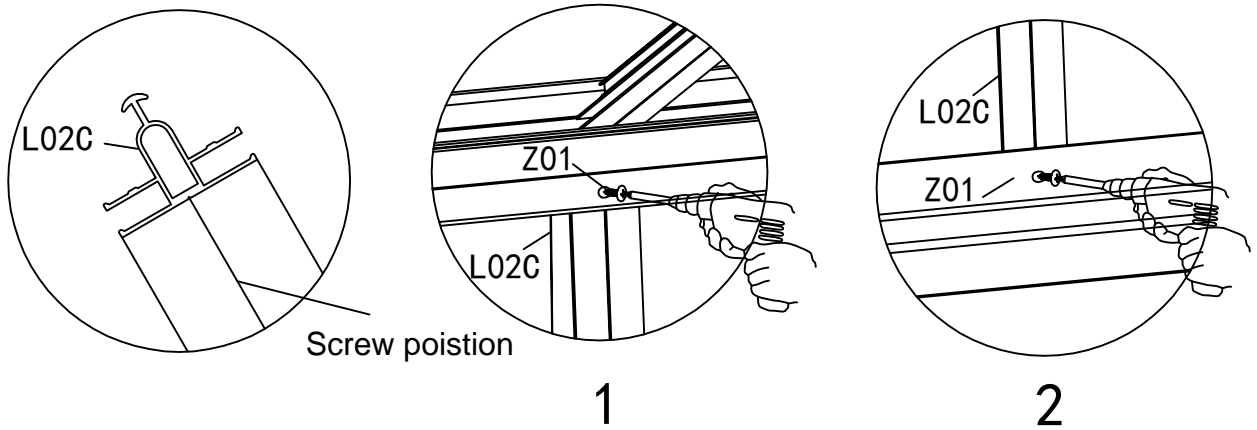

After the roof vents are in position, fix the last of the glazing bars (L02C) to the eaves (L07) and the ridge (L06) with the self-tapping screws (Z01) using a powered screwdriver. The inside of the glazing bars feature guide lines which indicate the correct screw positions (see detail drawings below). Be careful to ensure that the screws are in the correct position (see detail drawings below).



PART	NO	QTY
	L03B	1
	W08	1
	S01	4
	M6X10	
	M01	4
	M6	

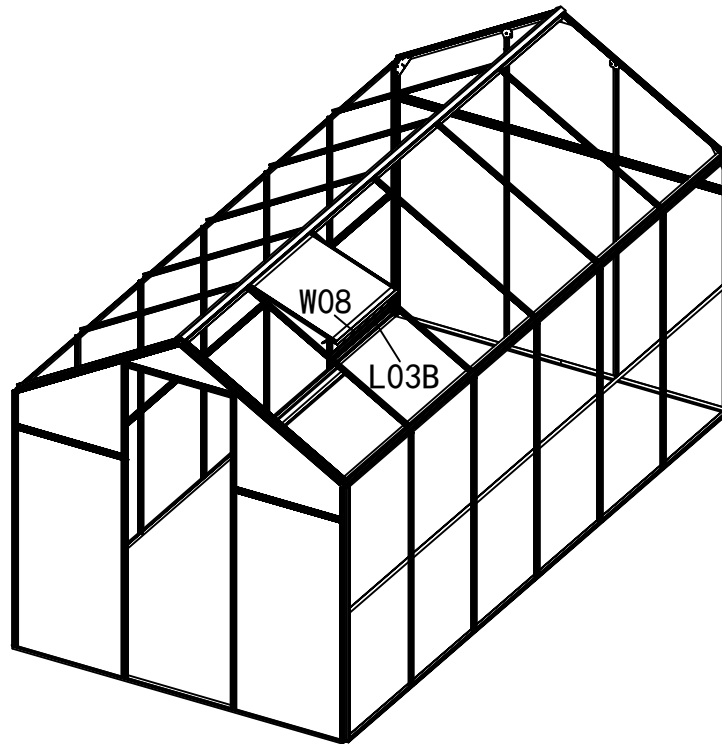

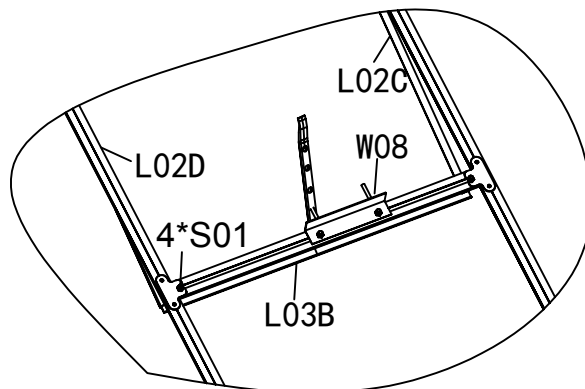
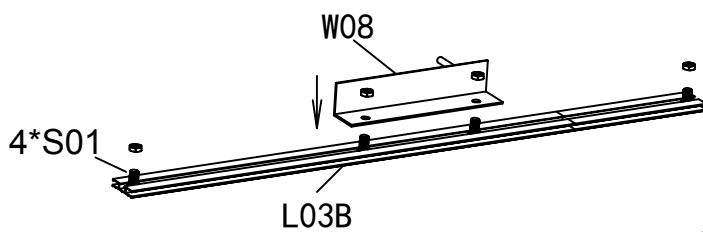

1. Slide 4 bolts (S01) into the bolt channel on the inside of L03B horizontal framing.
2. Use 2 of the bolts (S01) to bolt L03B horizontal framing to the glazing bars.
3. Use the other 2 bolts (S01) to bolt the window pins (W08) to L03B.

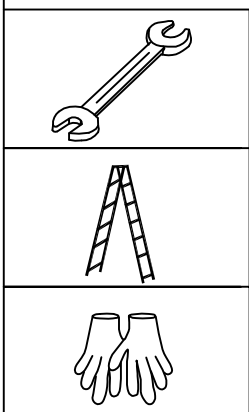

1



PART	NO	QTY
	L12A	2
	Z01 M4.2X16	20
	M01 M6	4

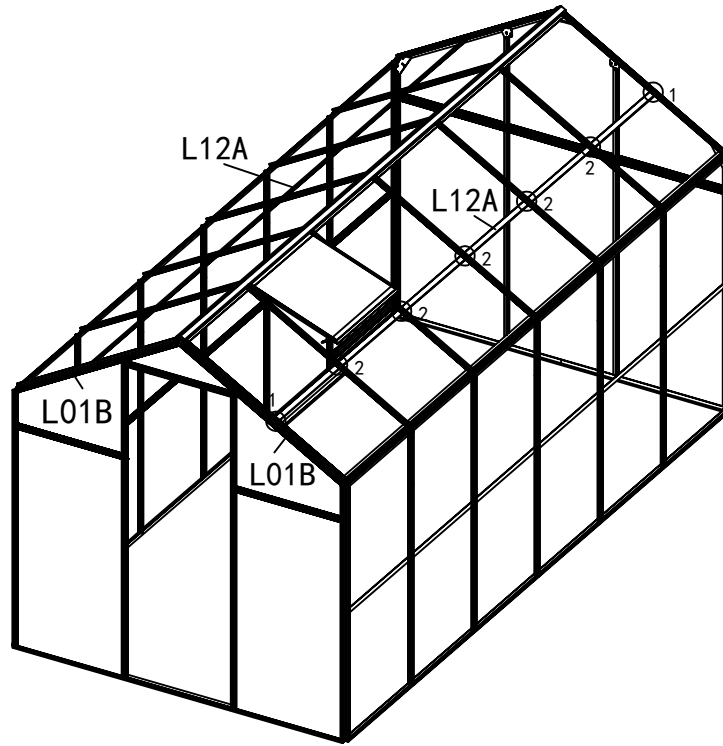

1. Make a pencil mark on the end roof glazing bars (L01B) at a height of 421mm from the bottom.
2. Bolt 2 x L12A at each end to 4 x L01B using the extra S01 bolts placed in the bolt channels earlier. Please note, if extra bolts were not placed in the bolt channel earlier L01B must be unbolted at one end and moved enough to squeeze the bolts in.
3. Fix L12A to the roof glazing bars (L02B, L02C and L02D) with the self-tapping screws (Z01) using a powered screwdriver. The inside of the glazing bars feature guide lines which indicate the correct screw positions (see detail drawings below). Be careful to ensure that the screws are in the correct position (see detail drawings below).
4. Ensure that L12A is fixed at a right angle (90 degrees) to the glazing bars.

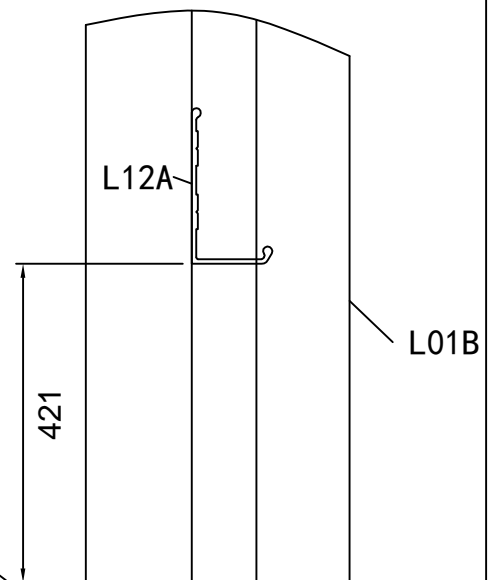
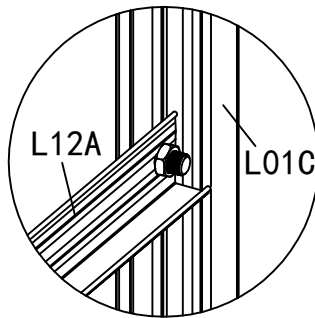
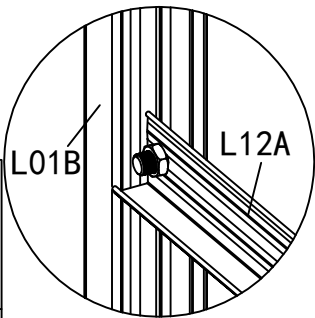



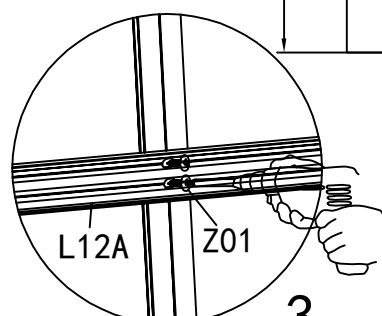
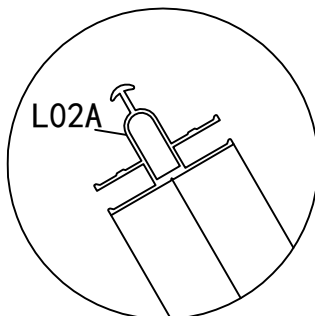

1

2

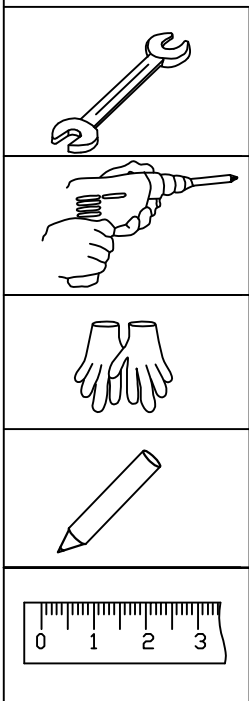



3

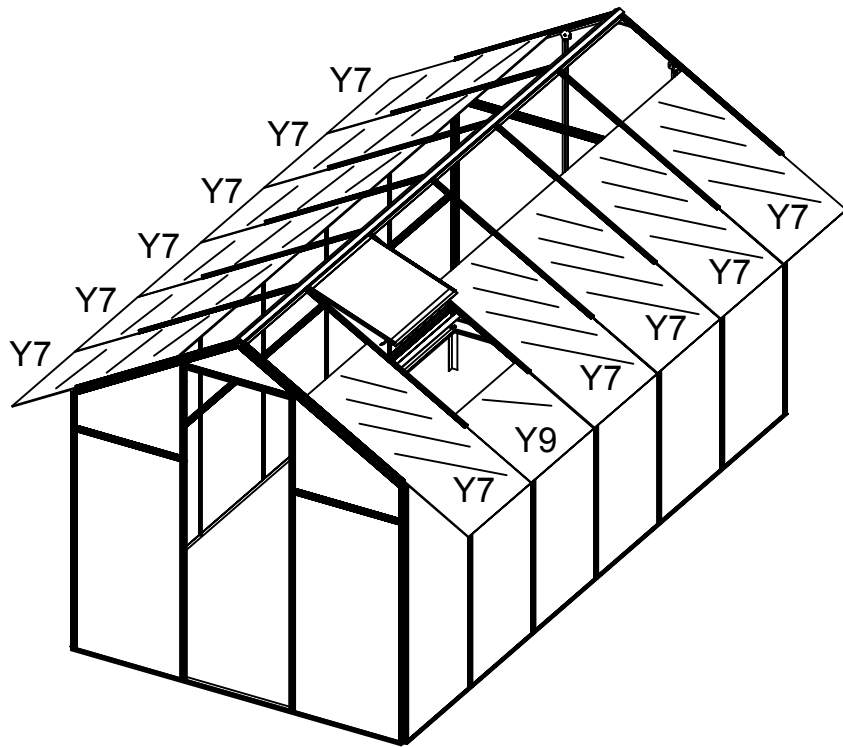
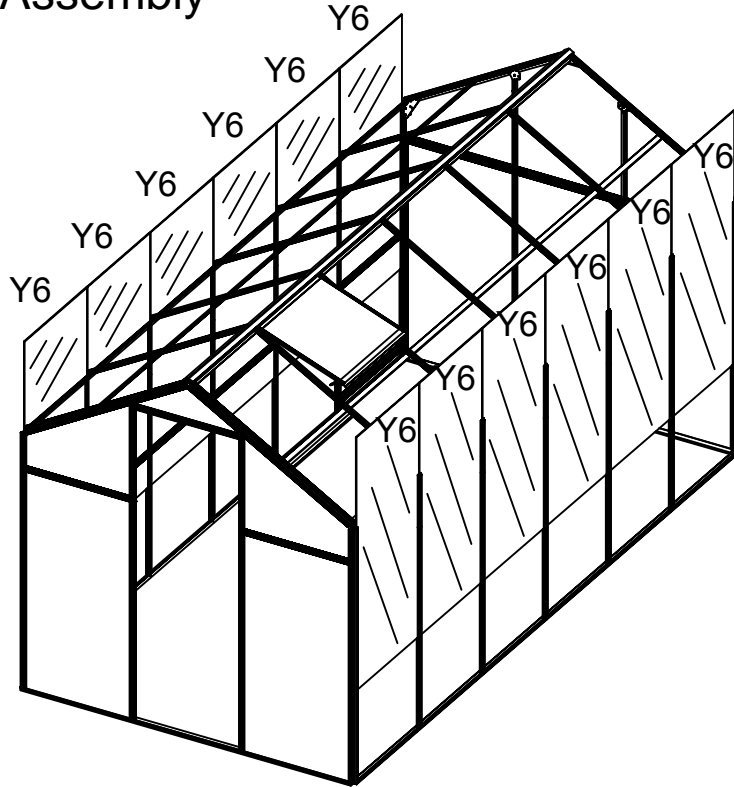

PART	NO	QTY
	Y6	12
	Y7	11
	Y9	1

Panel Assembly



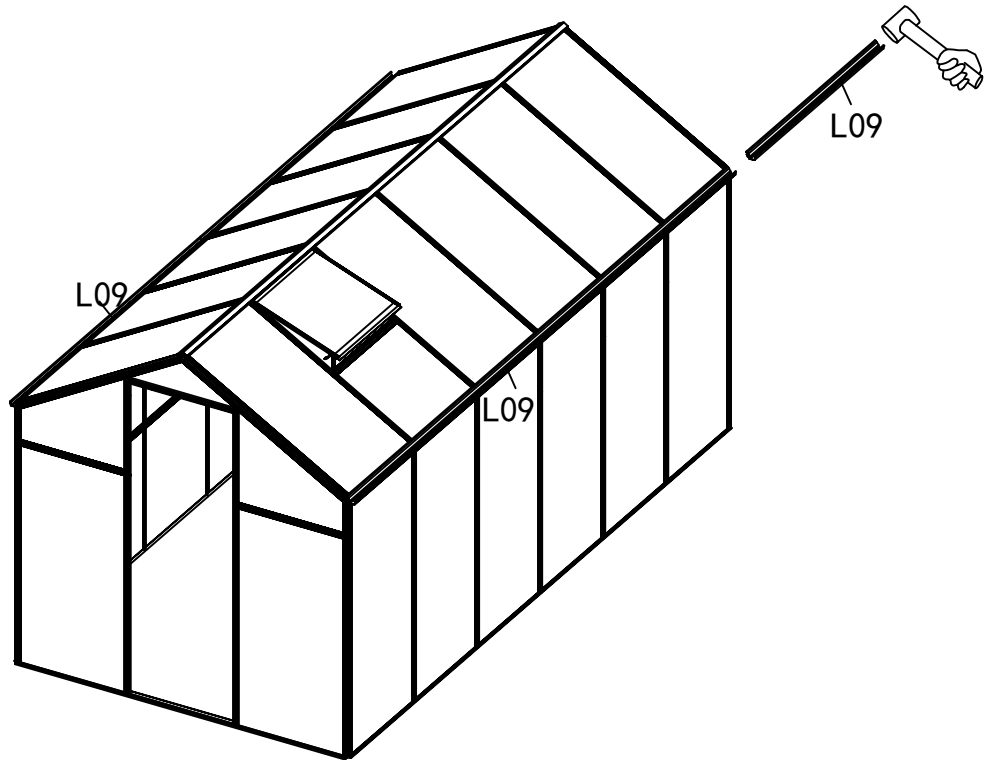

PART	NO	QTY
	L09	2

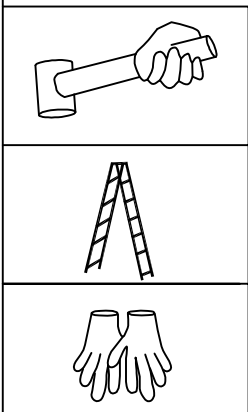
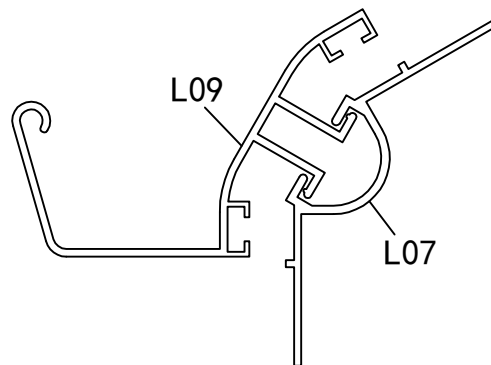

After the glazing panels are in position, slide the gutter (L09) into position along the eaves (L07). The gutter (L09) locates in a groove in the eaves (L07). If required use a mallet.



PART	NO	QTY
	L14	1
	M01 M6	3

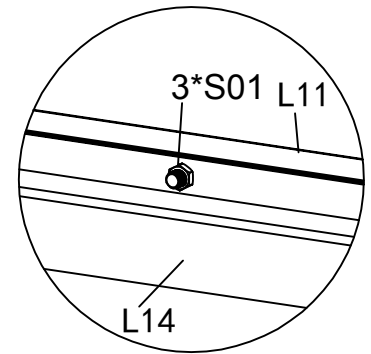
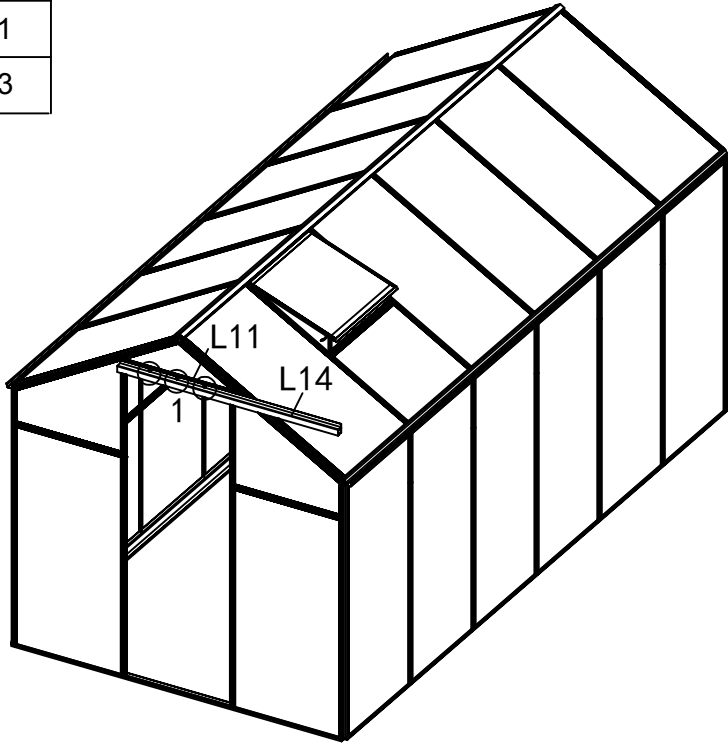

1

1. Bolt the door support rail (L14) to the horizontal framing (L11) using 3 extra S01 bolts placed in the bolt channels earlier. Please note, if extra bolts were not placed in the bolt channel earlier L01A must be unbolted at one end and moved enough to squeeze the bolts in.
2. Slide the door into position along the door support rail (L14). The door wheels are located on a lip at the bottom of L14.

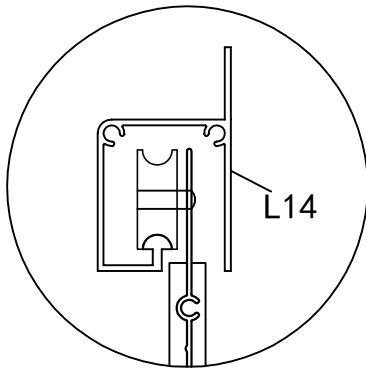

Door

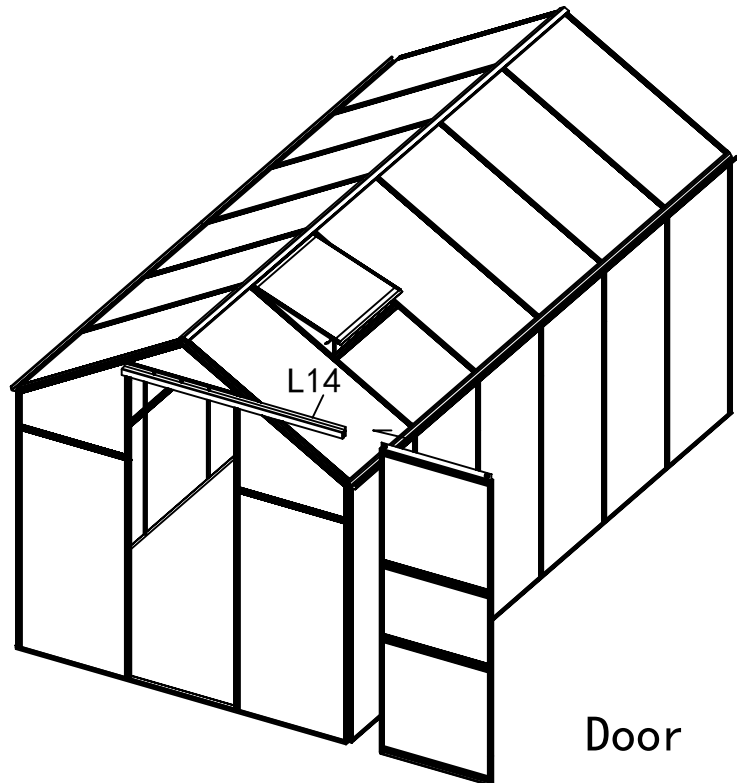

Door

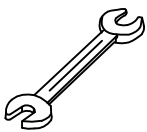



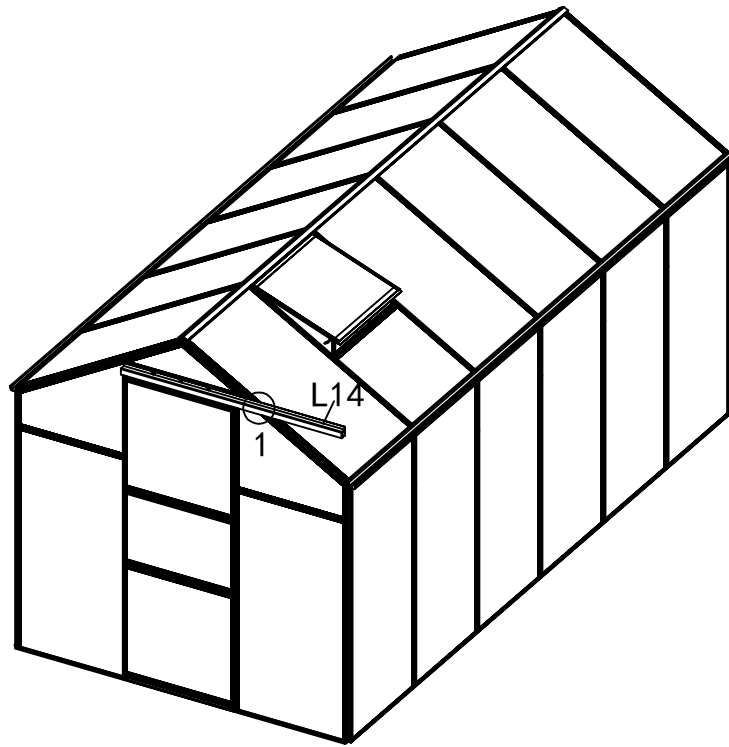

PART	NO	QTY
	Z01	1
	M4.2X16	

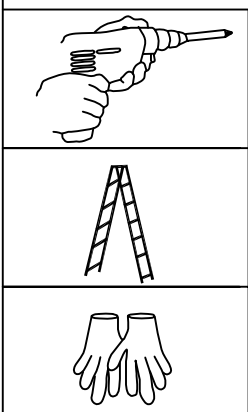
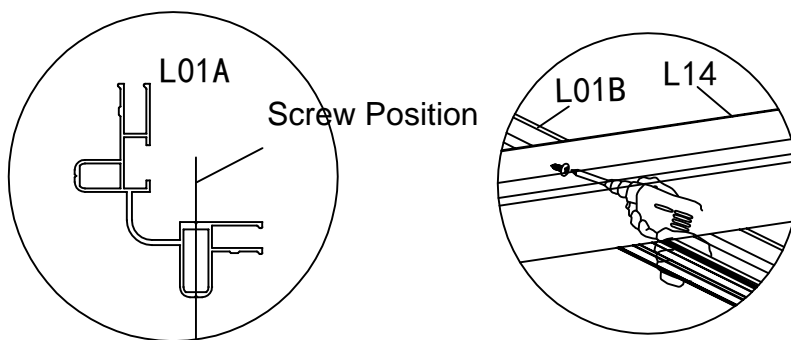

1. Adjust the door until it moves smoothly
2. Fix L14 to the end roof glazing bar (L01B) with the self-tapping screws (Z01) using a powered screwdriver. The inside of the glazing bars feature guide lines which indicate the correct screw positions (see detail drawings below). Be careful to ensure that the screws are in the correct position (see detail drawings below).



PART	NO	QTY
	J01	2
	J02R	2
	J02L	2
	J03	2
	Z01 M4.2X16	20

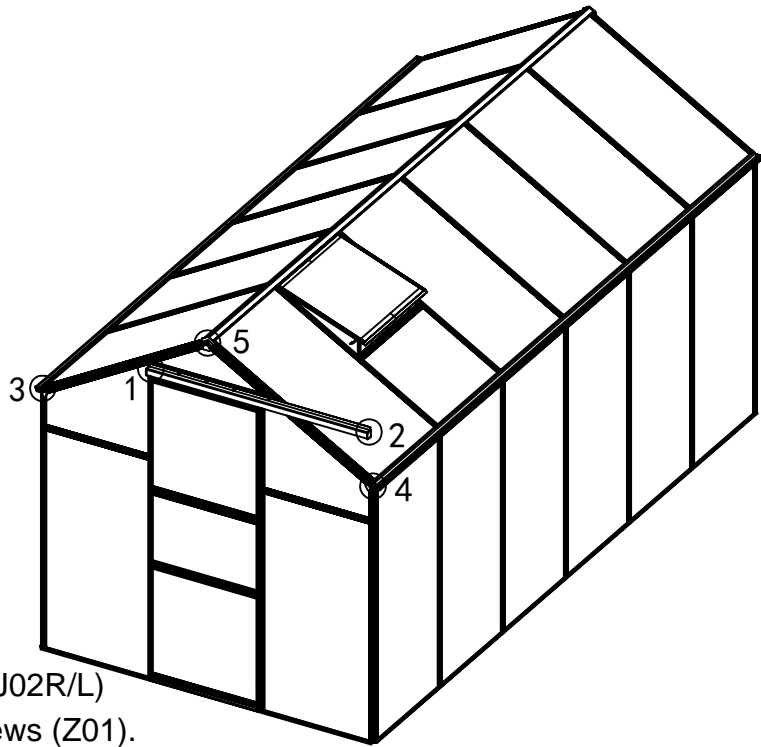

Fix the cover caps (J01, J03 and J02R/L) carefully with the self-tapping screws (Z01). Be careful to ensure that the screws are driven in straight and in the correct position (see detail drawings below).

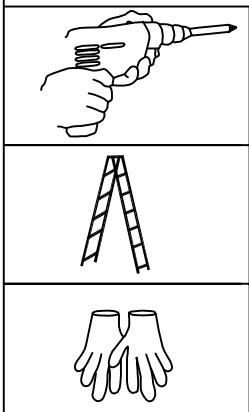
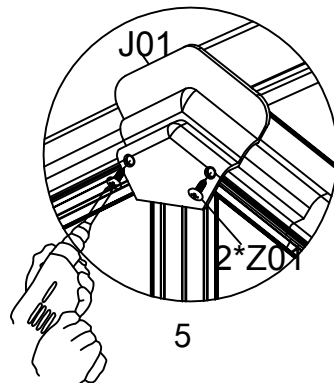
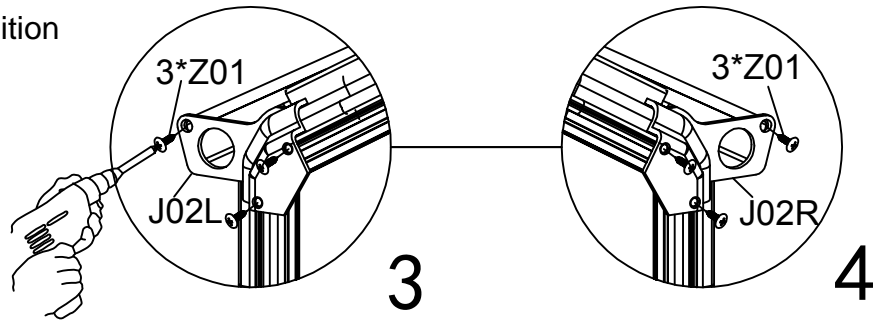
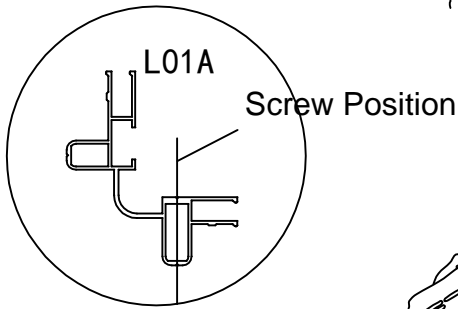
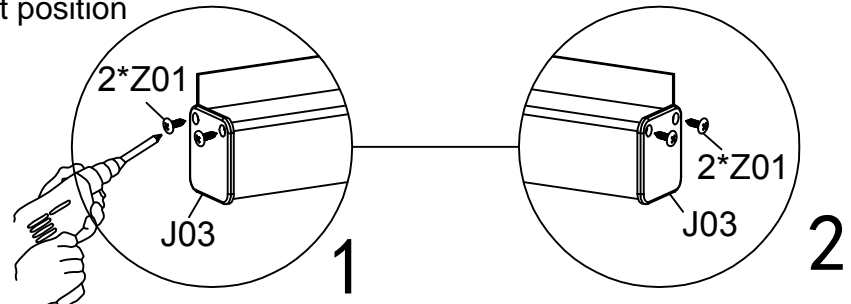

Contact information

Head office:

Dancover A/S
Lyngevej 16A, Nørre Herlev
3400 Hillerød
Denmark

For more information
please visit:
www.dancovershop.com

National contact

Denmark:

denmark@dancover.com

UK:

uk@dancover.com

Germany:

germany@dancover.com

France:

france@dancover.com

Sweden:

sverige@dancover.com

Finland:

suomi@dancover.com

Poland:

polska@dancover.com

Luxembourg:

luxembourg@dancover.com

Portugal:

portugal@dancover.com

Spain:

espana@dancover.com

Italy:

italia@dancover.com

Switzerland:

schweiz@dancover.com

Austria:

austria@dancover.com

Norway:

norge@dancover.com

Nederland:

nederland@dancover.com

Ireland:

ireland@dancover.com

Belgium:

belgique@dancover.com