

**DANCOVER<sup>®</sup>**

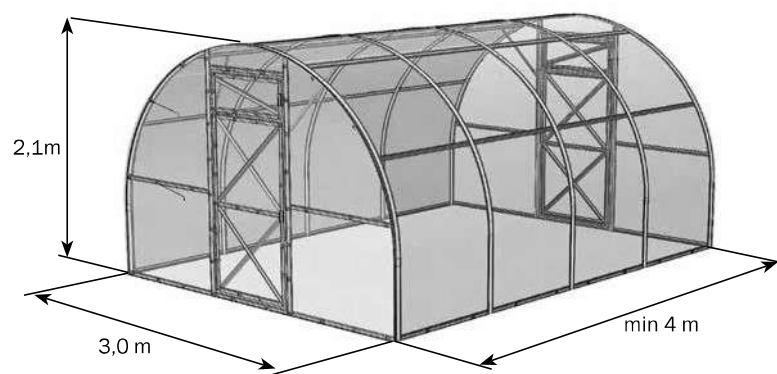

Manual  
for  
Greenhouse  
TITAN Arch 60



**! Perform assembling and operation of the greenhouse in strict accordance with the manual and operating rules stated in the technical certificate. Please keep this technical certificate for further reference.**

**Description**

Orbita greenhouse is designed for creation microclimate favorable for growing garden crops on cottage and household plots.

Greenhouse might have variable length depending on customers' desire. Required length of greenhouse is provided by purchasing of packages with extending inserts. Each insert add 2 m to base length. Base length is 4 m. Height of installed frame is 2.1 m

The frame of the greenhouse is made of galvanized iron and is to be assembled with screws and nuts. Greenhouse is fixed on the ground by digging special frame endings or on fundament using angles. Complete set includes all that is needed for fastening of coverage. Greenhouse may be completed with coverage on buyer's request. Greenhouse has two door openings and two small windows in opposite ends.

Greenhouse base requires 3 sheets of cellular polycarbonate 2.1x6 m with 6 mm thickness. For each Inserts - 1 sheet of cellular polycarbonate 2.1x6 m

**Operation rules**

Before the start of operation, the greenhouse should be assembled and installed as prescribed in the manual. When the greenhouse is assembled by a third party the customer should supervise the quality of works to ensure compliance with the present manual. Some detail have extra holes due to uniformity of details. During assembly, be careful not to damage the parts, because until they assembled fully, they do not have sufficient rigidity. Use supports (e.g., chairs) at intermediate stages of assembly to evenly raise the assembled frame. To align the holes in difficult joints use a nail with a diameter of 4mm or mandrel with a conical end. During assembly of the frame details' connections should be Implemented for all specified openings. Simplified connection of the parts is a violation of assembly rules and cause of removal warranty support by manufacturer.

Do not install the greenhouse too close to buildings or trees where masses of snow/ice can fall on it. Recommended distance is at least 2 m. The greenhouse is designed to withstand wind at the speed below 17 m/sec. The greenhouse cladding should not be removed for the winter period if snow load is limited. If the greenhouse is left unattended for the entire winter the customer should either remove the cladding or estimate the possible snow load. For the frame assembled the layer of snow weight is 60 kg per 1 sqm of horizontal surface.

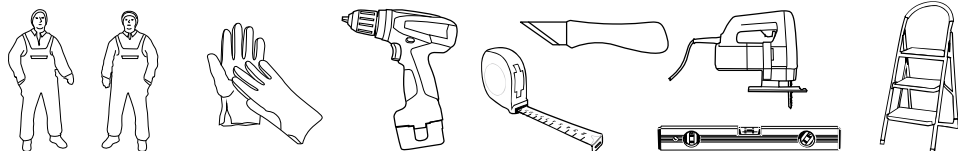

**Cleaning and washing sheets of polycarbonate**

1. Rinse the sheet with warm water.
2. Wash the sheet with a solution of mild soap or with a household detergent and warm water, using a soft rag or a sponge to remove dirt.
3. Rinse with cold water and wipe with a soft cloth.

Never use abrasives or highly alkaline cleaning compositions for cleaning polycarbonate sheets. Dry rubbing of the surface will damage the protective layer of the cladding and shorten its shelf life. Never rub the surface of polycarbonate sheets with brushes, metallic cloth or other abrasive materials.

When disinfecting the greenhouse from pathogens causing fungal and bacterial diseases, do not use «sulfur blocks» to avoid frame corrosion (blackening).



















**Warranty liabilities**

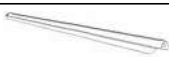















1. The manufacturer is responsible for the completeness of the product.
2. The manufacturer is responsible for assemblability of the greenhouse in accordance with the instructions.
3. The manufacturer is responsible for the greenhouse durability in the specified weather conditions.
4. Term for making claims is 24 months from the day of purchase



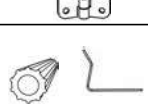

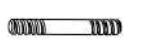







**Terms of warranty provisions**

















Warranty does not apply to cases of:

1. Greenhouse installation in violation of instruction requirements
2. Violation of the rules of operation.
3. Inappropriate use of the greenhouse.
4. Deformation of the greenhouse as a result of ground movement.
5. Floods, hurricanes and other natural disasters.

N°	marking	description		quantity
<b>1 BASIC BOX</b>				
1	<b>4Н</b>	Bottom arc	L=1,62 m 	6
2	<b>4В</b>	Top arc	L=1,62 m 	3
3	<b>4ВК</b>	Top end arc	L=1,62 m 	2
4	<b>4НКП</b>	Right end bottom arc	L=1,62 m 	2
5	<b>4НКЛ</b>	Left end bottom arc	L=1,62 m 	2
6	<b>1</b>	Stand	L=0,92 m 	10
7	<b>2В</b>	Top balk	L=0,96 m 	12
8	<b>9-1</b>	Bottom door opening stand	L=0,98 m 	4
9	<b>9-2п</b>	Right top door opening stand	L=1,4 m 	2
10	<b>9-2л</b>	Left top door opening stand	L=1,4 m 	2
11	-	End ampflifier		4
<b>2 BASIC BOX</b>				
12	<b>11п</b>	Middle right end strainer	L=1,02 m 	2
13	<b>11л</b>	Middle left end strainer	L=1,02 m 	2
14	<b>12д</b>	Door vertical	L=0,76 m 	8
15	<b>12ф</b>	Small window vertical	L=0,32 m 	4
16	<b>13д</b>	Door horizontal	L=0,71 m 	6
17	<b>13ф</b>	Small window horizontal	L=0,71 m 	4
18	<b>14</b>	Small door diagonal	L=0,96 m 	4

N°	marking	description		quantity
19	<b>15</b>	Large door diagonal	L=1,0 m 	4
20	<b>16</b>	Small window diagonal	L=0,74 m 	2
21	<b>2</b>	Balk	L=0,96 m 	16
22	<b>3</b>	Support	L=0,14 m 	14
23	<b>8</b>	Bottom end strainer	L=1,04 m 	4
24	<b>10</b>	Screed door opening	L=0,82 m 	4
25	-	Hook for door and small windows		4
26	<b>5</b>	Rotator cover plate	L=0,09 m 	4
27	-	Bracket		8
28	-	Bracket for the hook		8
29	-	Loops for doors and windows		8
30	-	Workpiece for locking (turner with 2 elastic nozzles)		4
31	-	Tube bend spinner		1
32	-	Handle		8
33	-	Pin		4
34	-	Screw M4 x 8		440
35	-	Screw M4 x 10		56
36	-	Screw M4 x 25		132

N°	marking	description	quantity
37	-	Screw M4 x 35 	32
38	-	Nut M4 	660
39	-	Washer 32x4 	160
40	-	Adhesive tape 	1
41	<b>2</b>	Balk L=0,96 m 	8
42	-	Siding L=1,05 m 	4
43	-	Siding L=1,0 m 	4
44	-	Top steel band 	5
45	-	Bottom steel band 	10
46	-	Bolt M6 x 60 	10
47	-	Nut M6 	10
48	-	Washer 6 	20
49	-	Bi-adhesive tape L=5 m 	2

N°	marking	description	quantity
<b>1 BOX INSERT</b>			
50	<b>4H</b>	Bottom arc L=1,62 m 	4
51	<b>4B</b>	Top arc L=1,62 m 	2
52	<b>1</b>	Stand L=0,92 m 	4
53	<b>2</b>	Balk L=0,96 m 	12
54	<b>2B</b>	Top balk L=0,96 m 	6
55	<b>3</b>	Support L=0,14 m 	4
56	-	Siding L=1,0 m 	4
57	-	Top steel band 	2
58	-	Bottom steel band 	4
59	-	Screw M4 x 8 	116
60	-	Screw M4 x 25 	24
61	-	Bolt M6 x 60 	4
62	-	Nut M4 	140
63	-	Nut M6 	4
64	-	Washer 6 	8
65	-	Washer 32x4 	16
66	-	Bi-adhesive tape L=5 m 	1

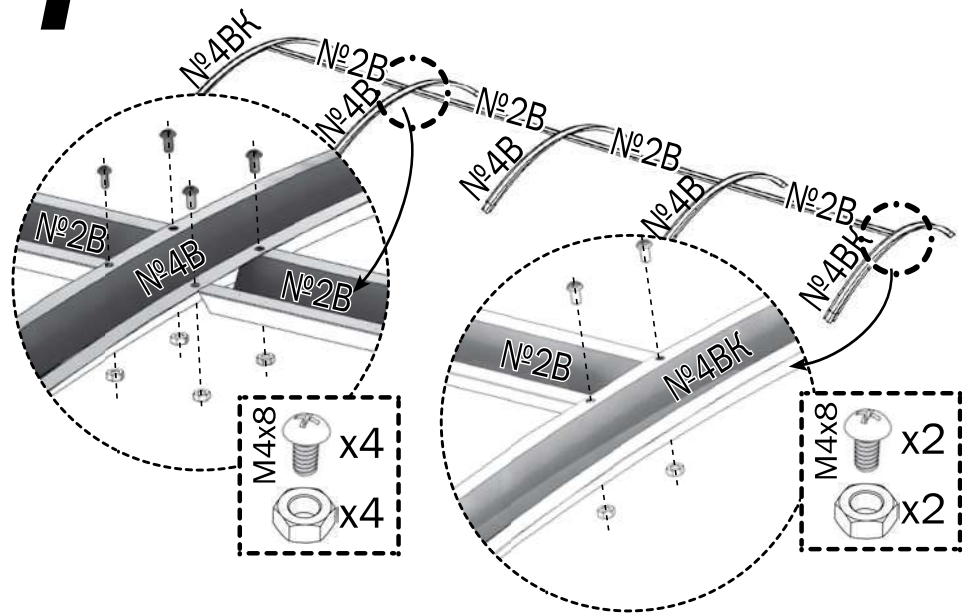
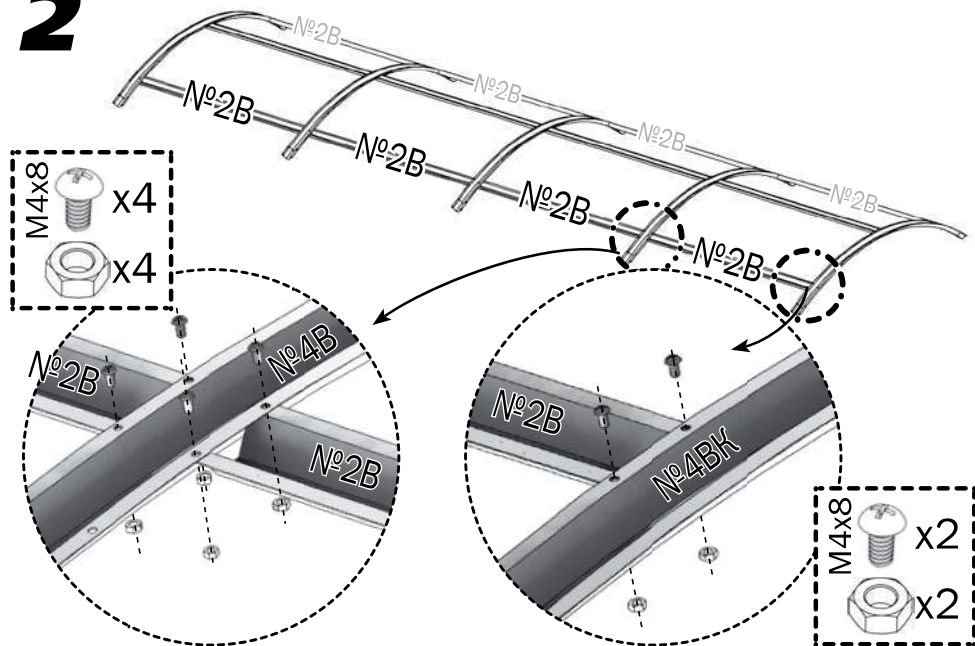
**1****2**

8

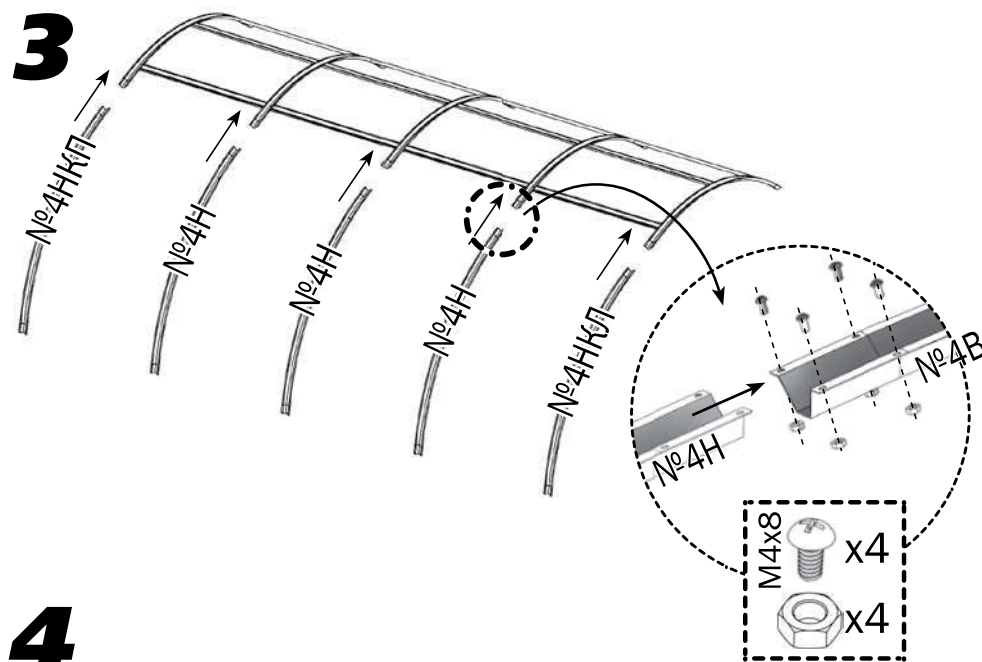
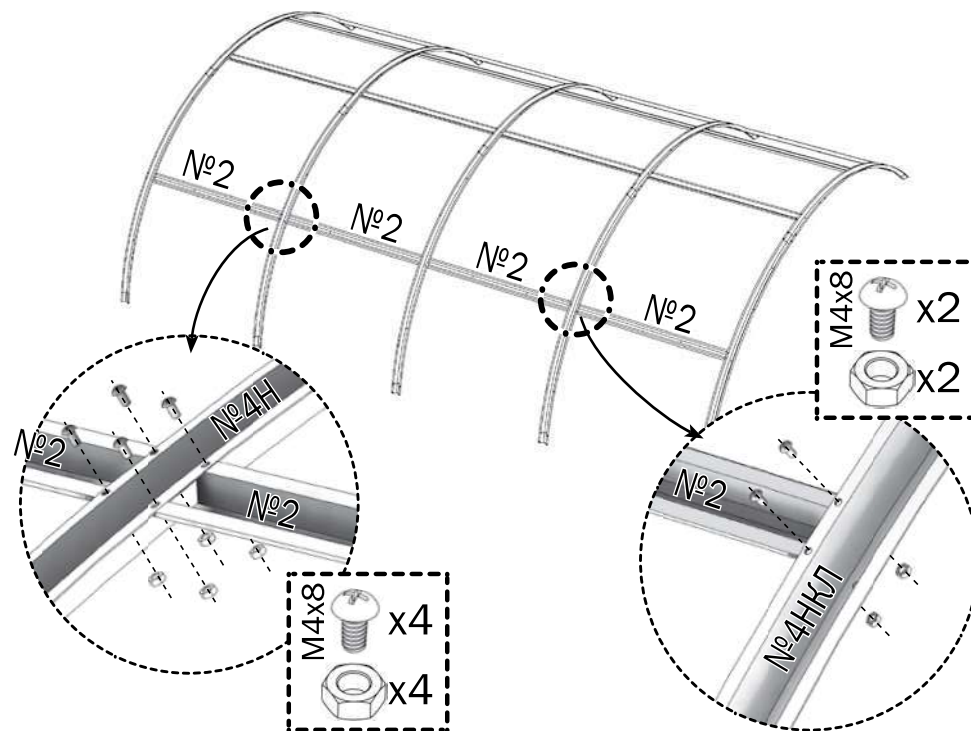
**3****4**

9

5

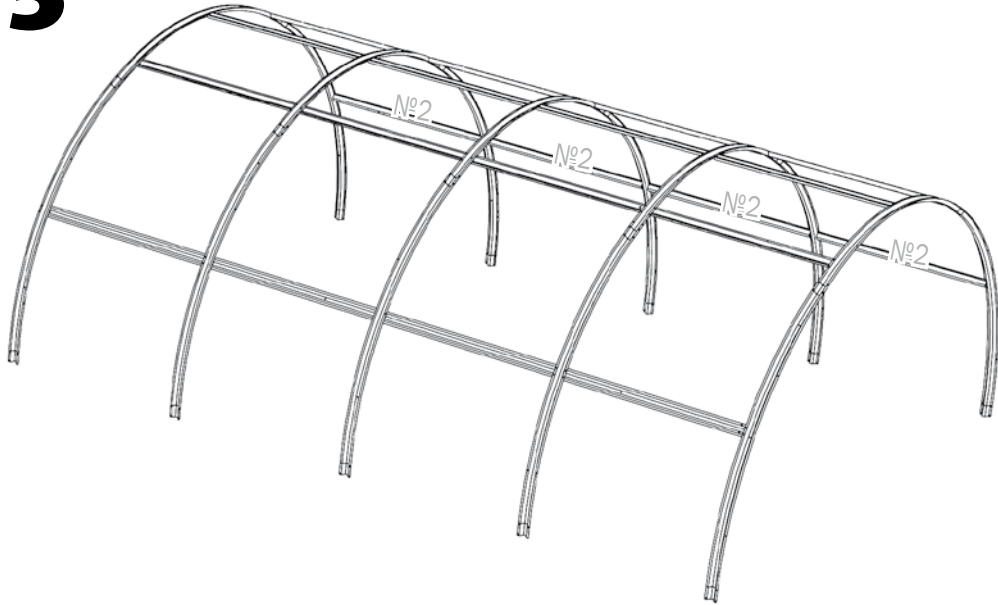

6

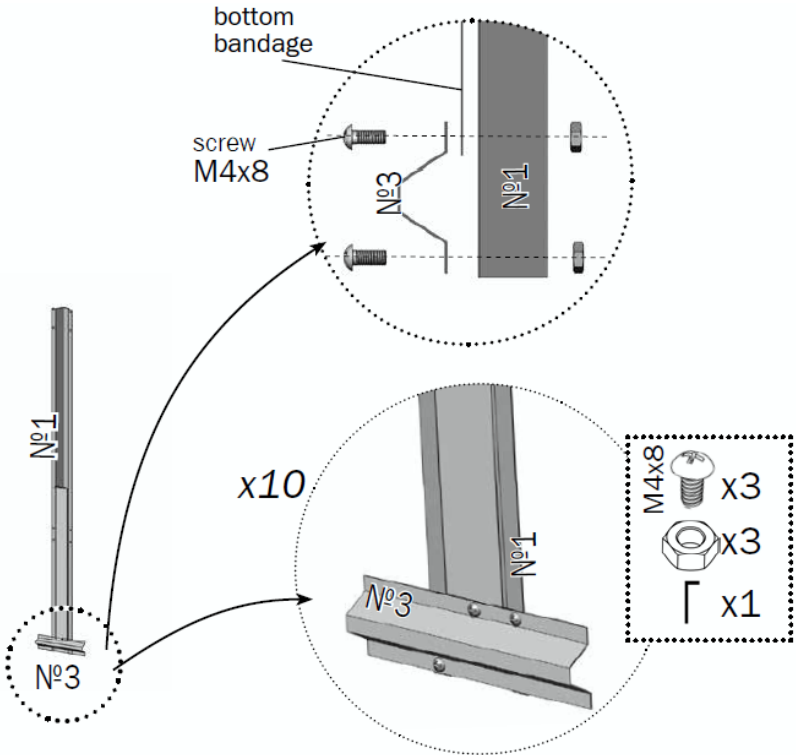

7

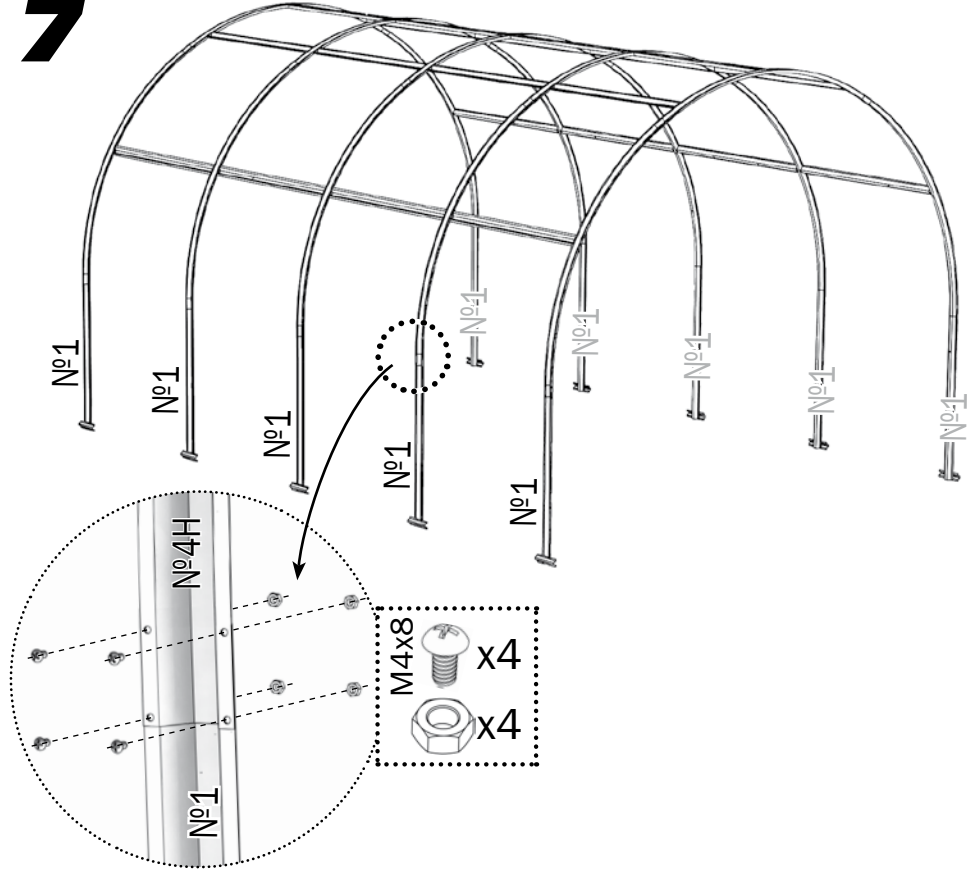

8

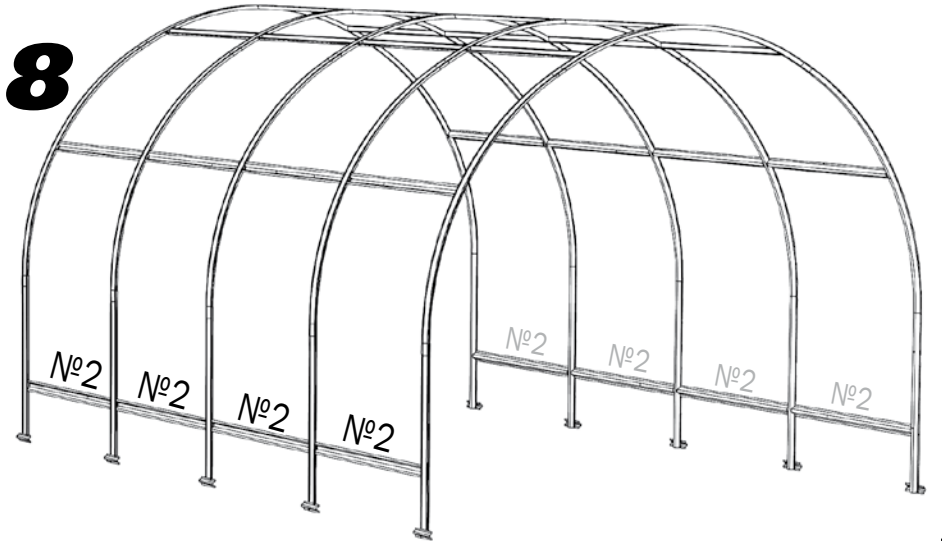



9

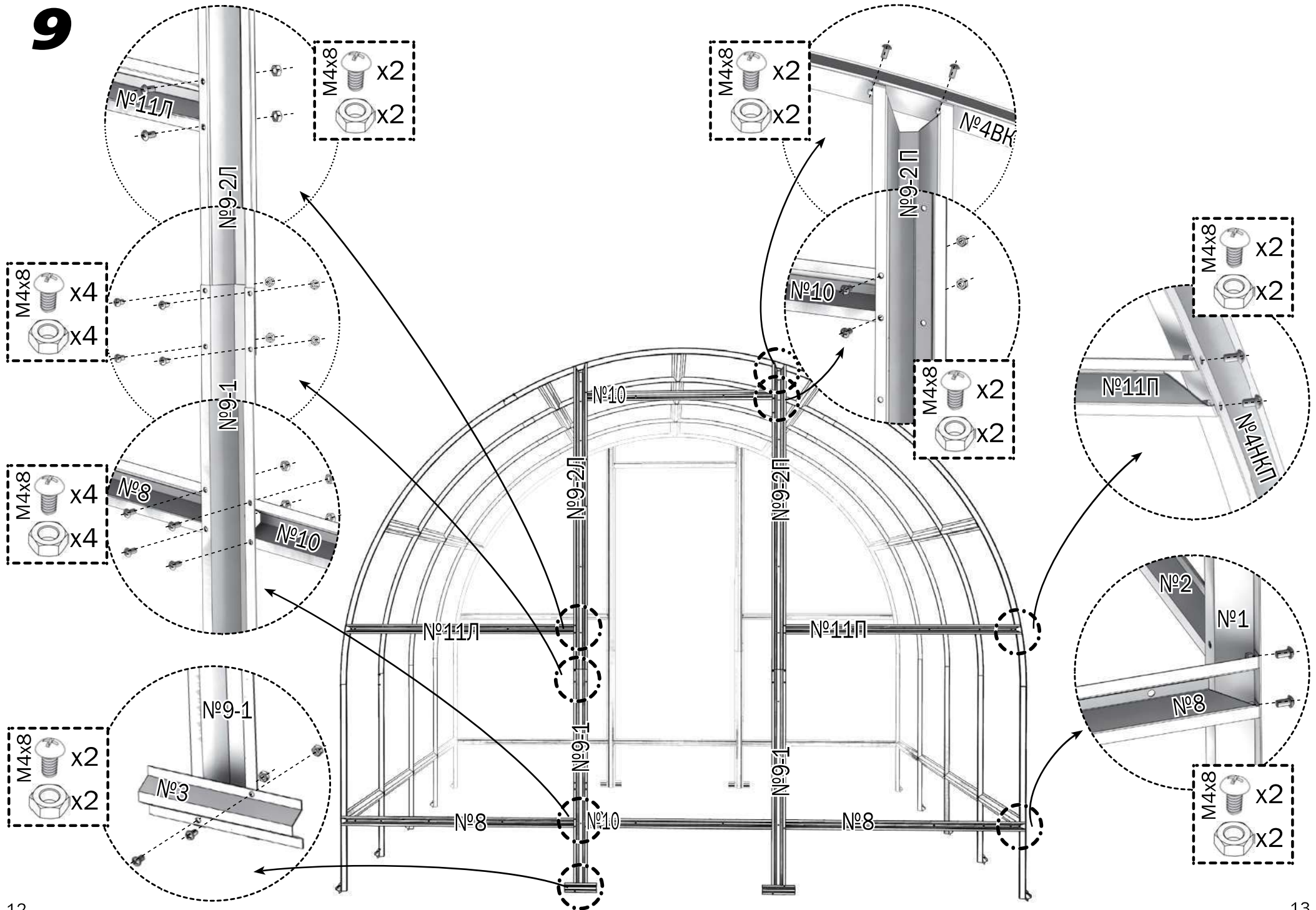



**10**

**BASIC**

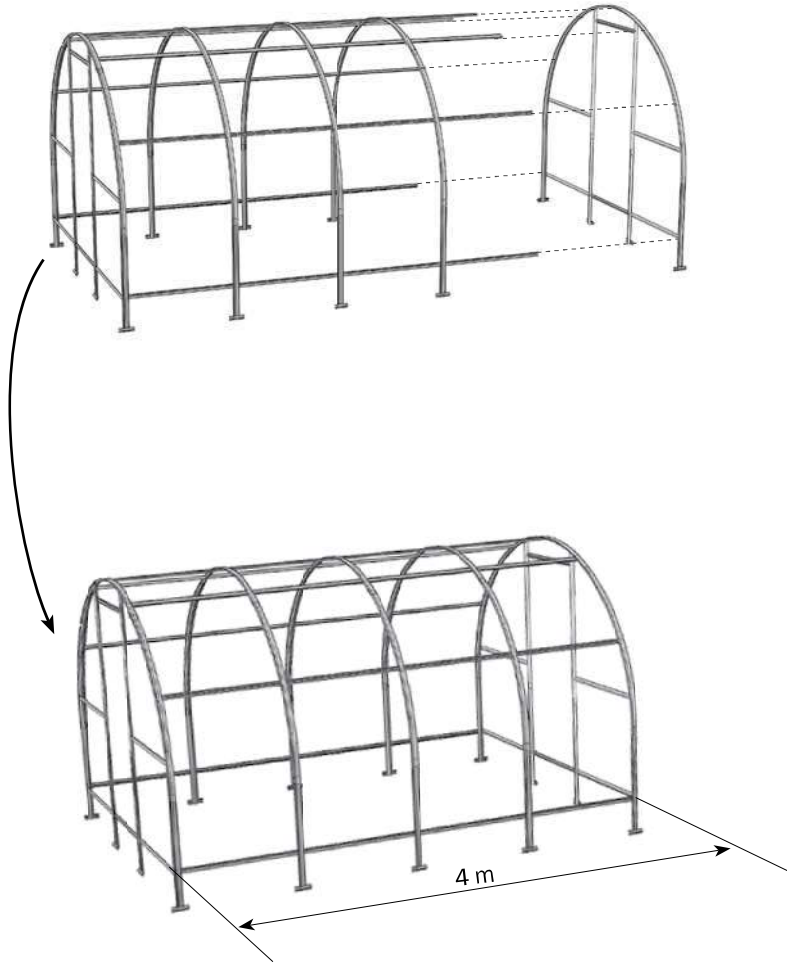

**10-A**

**INSERT**

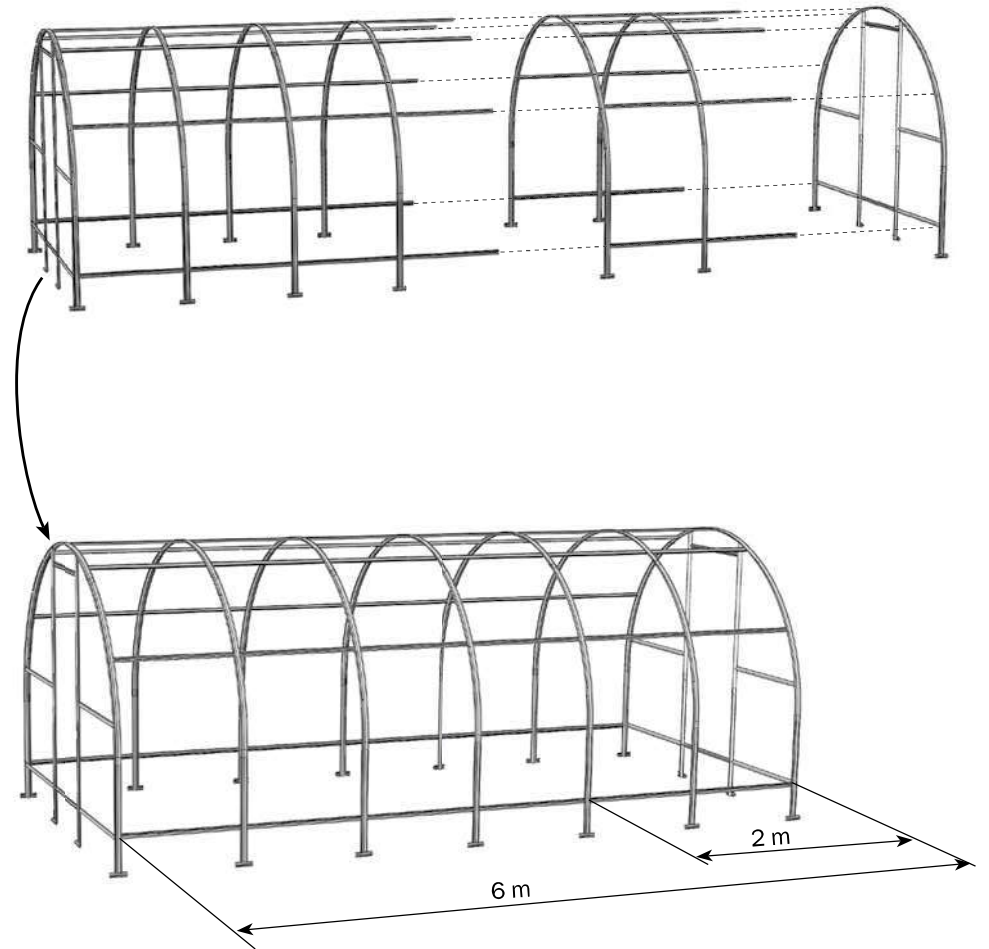

# 11

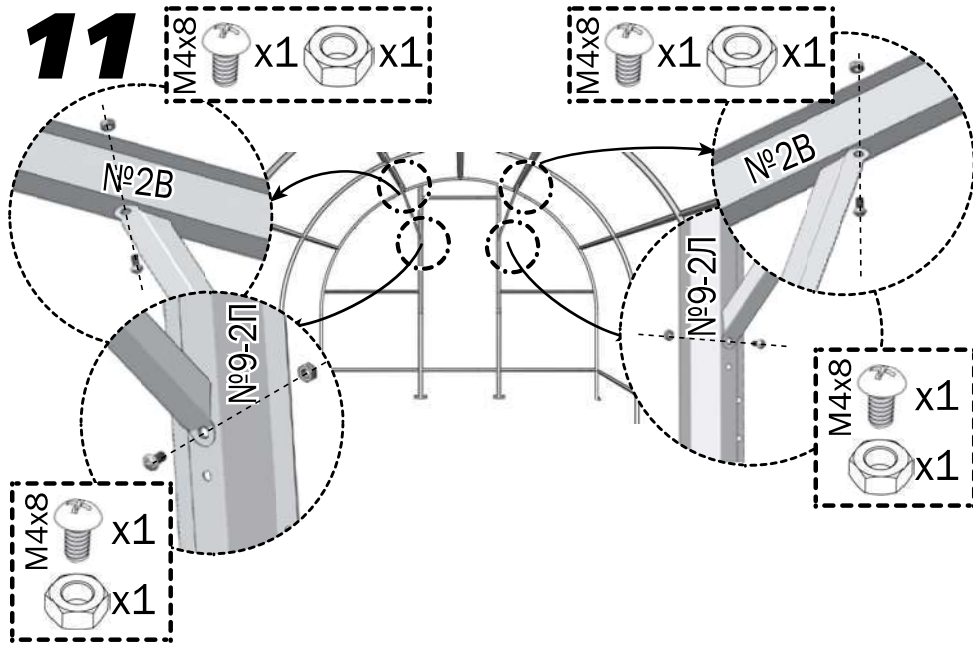

# 12

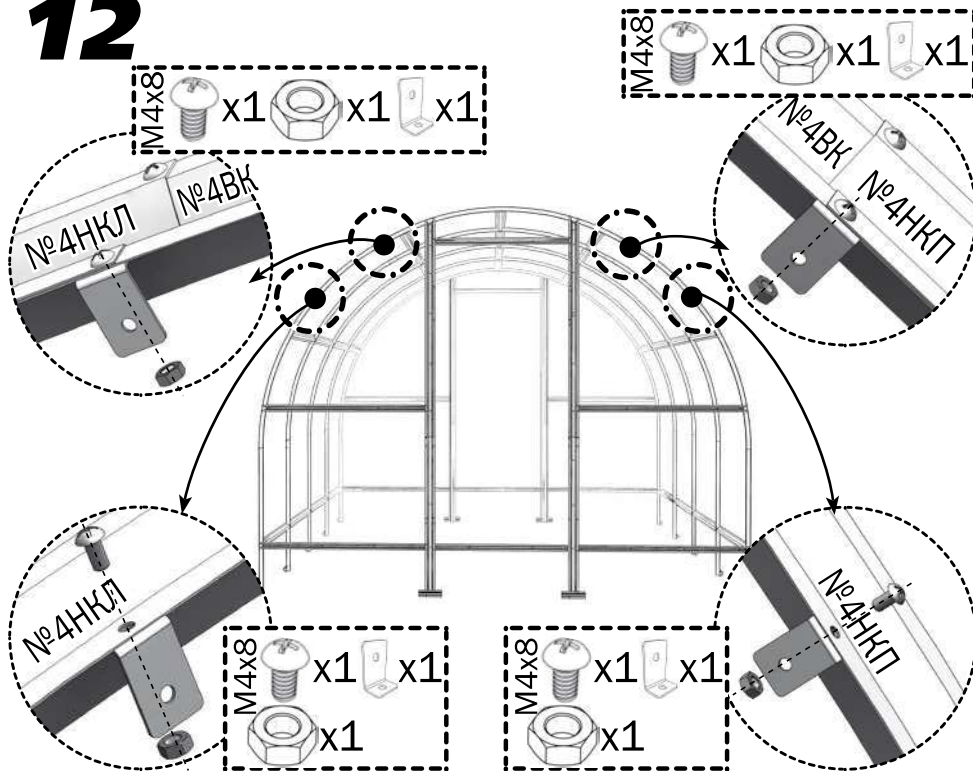

# 13

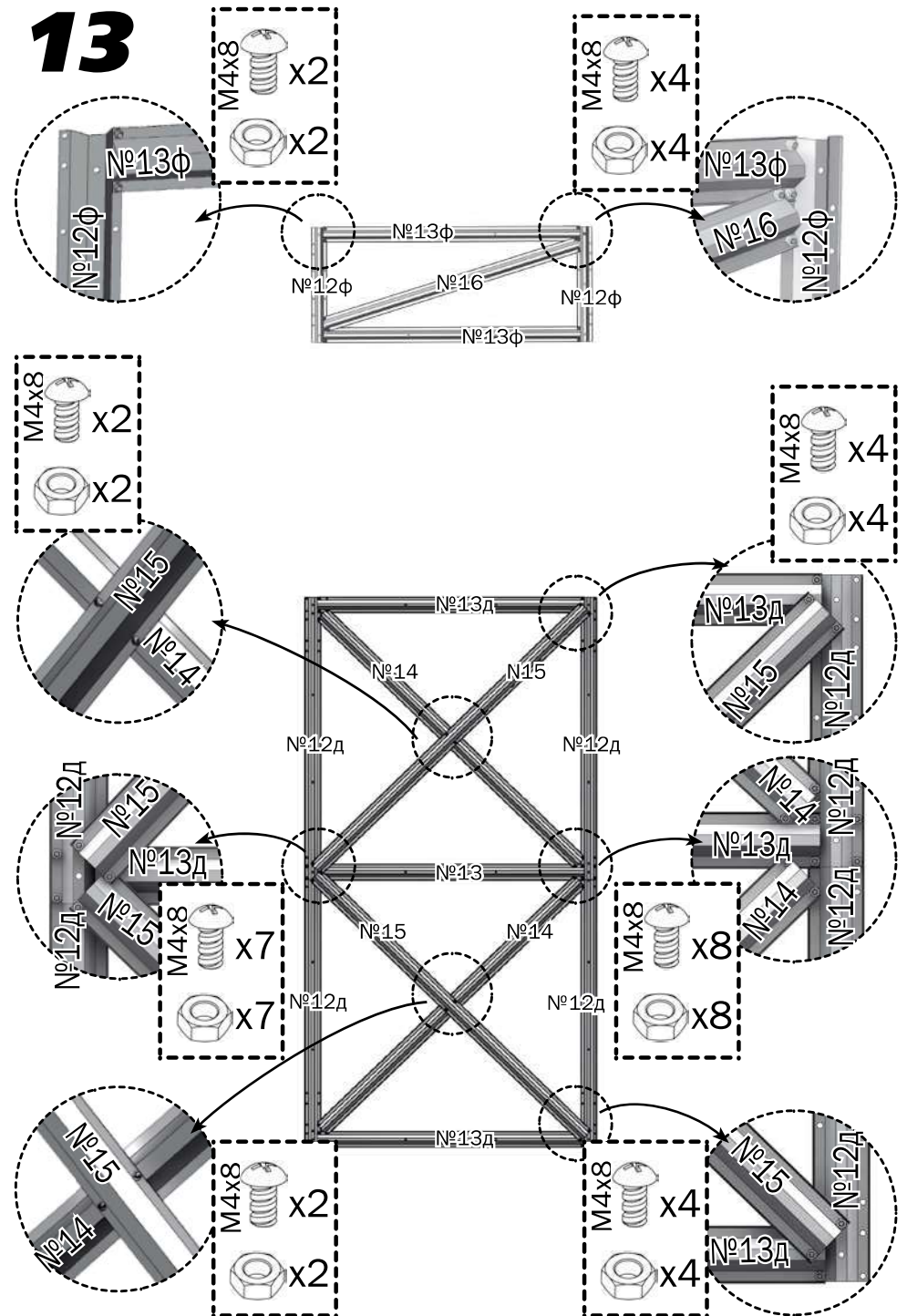

# 14

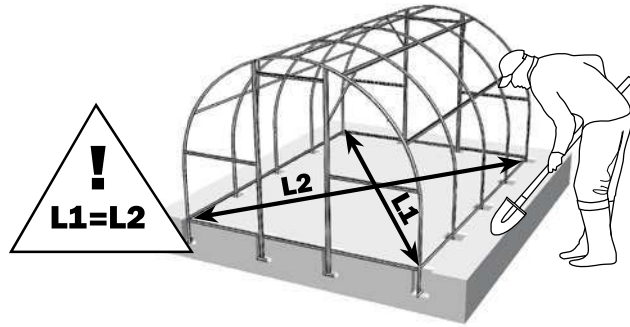

**15** Cellular polycarbonate shall be installed strictly defined side out (towards the sun), which has a protective layer. The protective layer is usually at the side with the inscriptions on the transport film. The film on the other side of sheet is transparent. After marking the sheet, but prior to its cutting, make a mark on the protected side of the sheet for each piece: after removal of the transport film sheet sides are not visually different. The transport film is stripped from both sides immediately before fixing the cladding on the frame.

Sections of polycarbonate with open honeycombs should be covered by adhesive tape

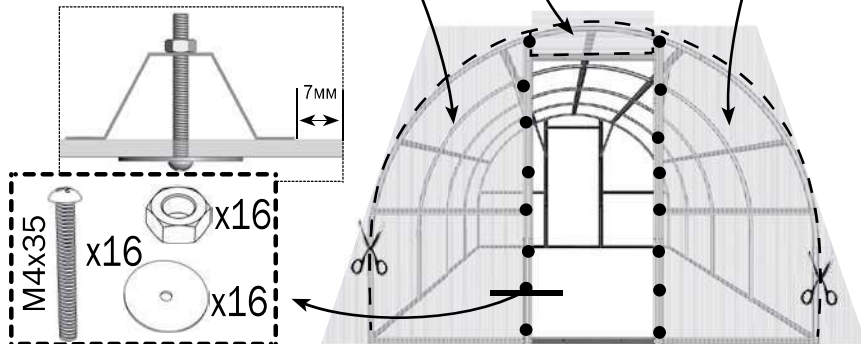
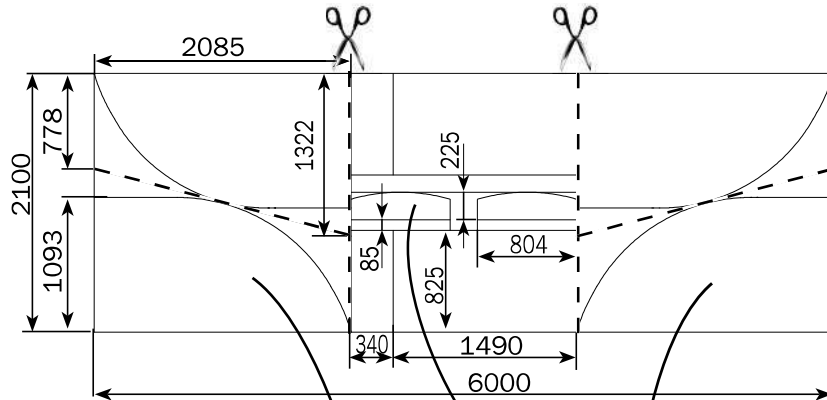
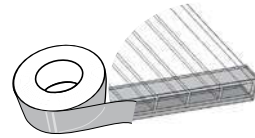

# 16

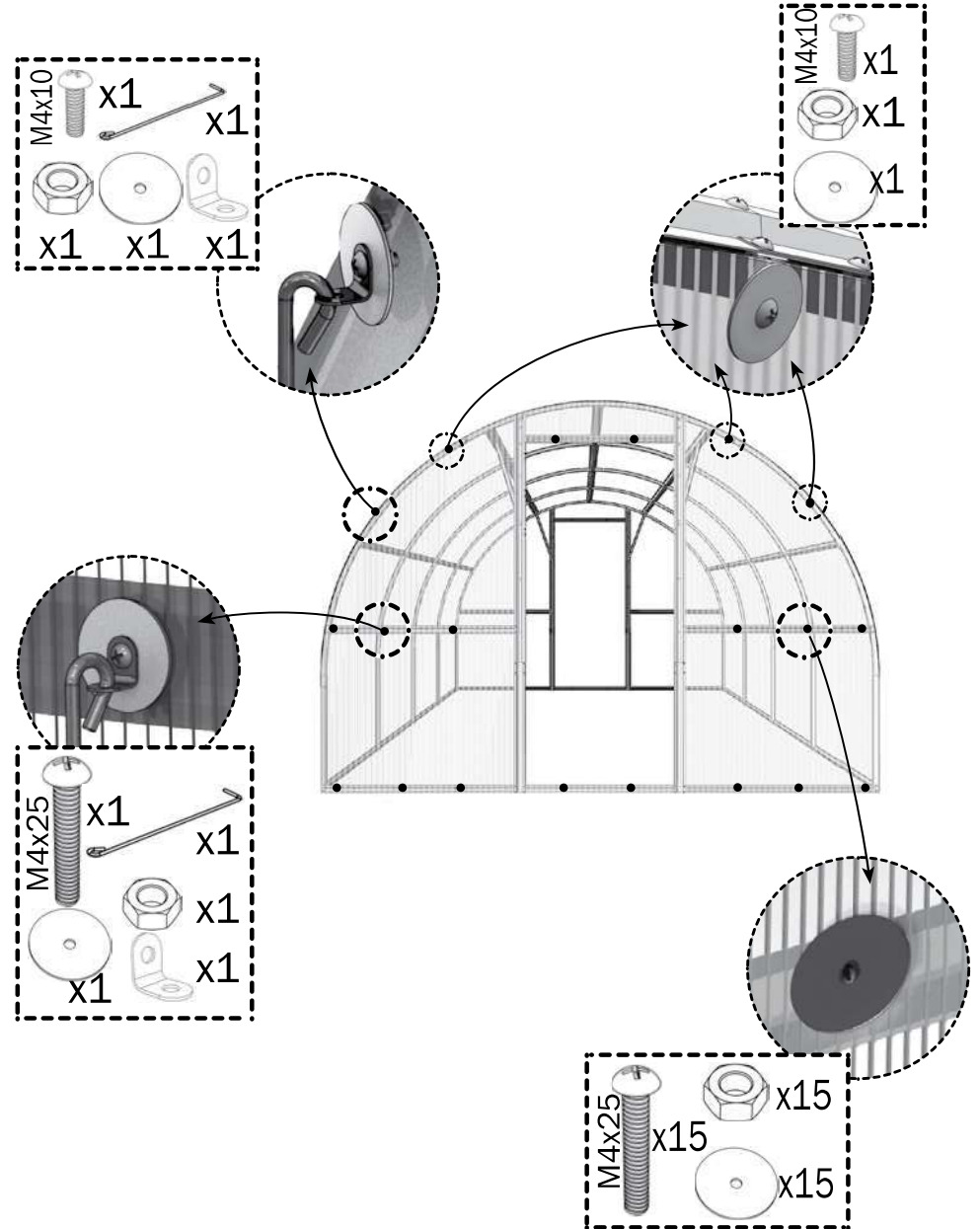

# 17

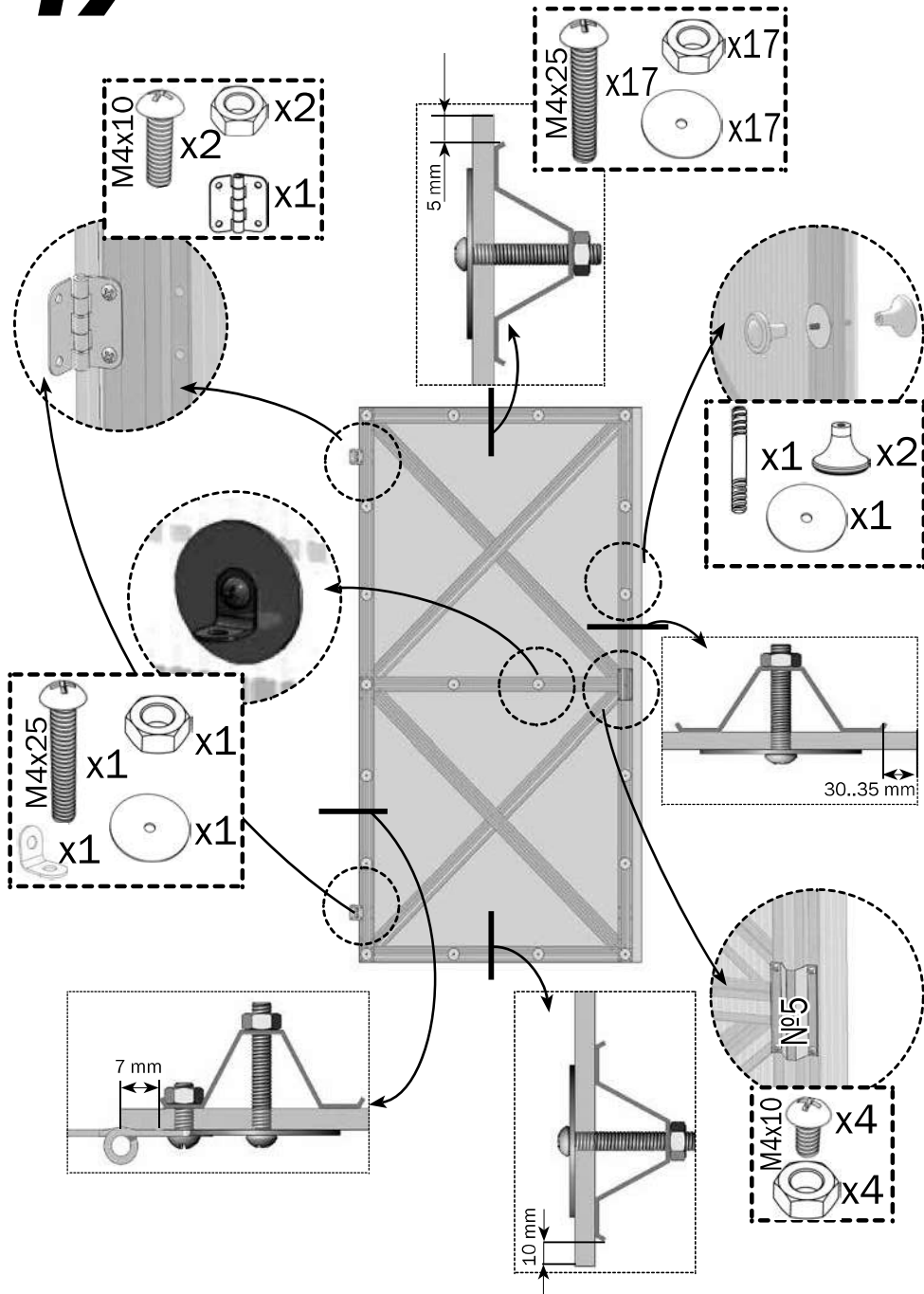

# 18

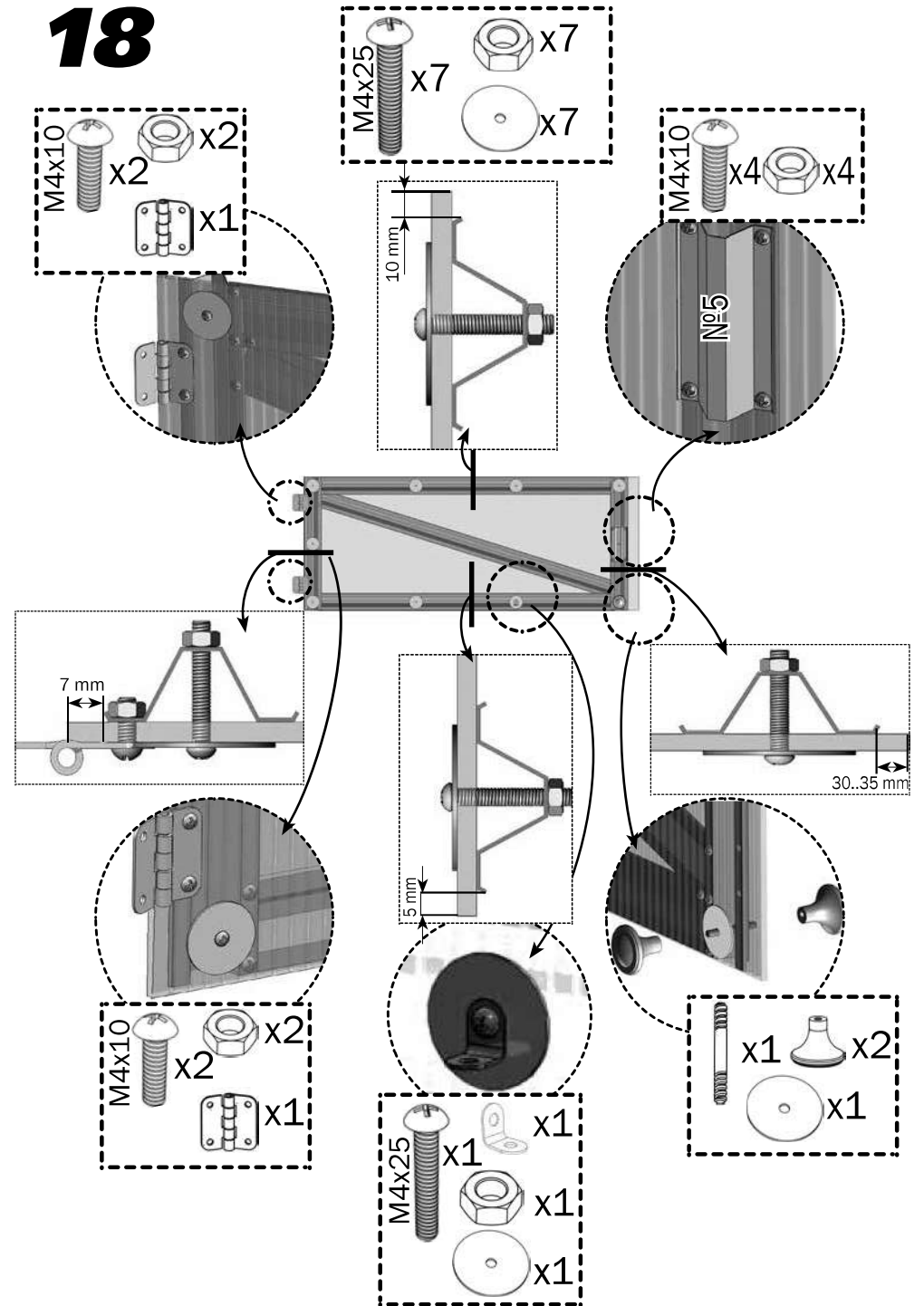



# 19

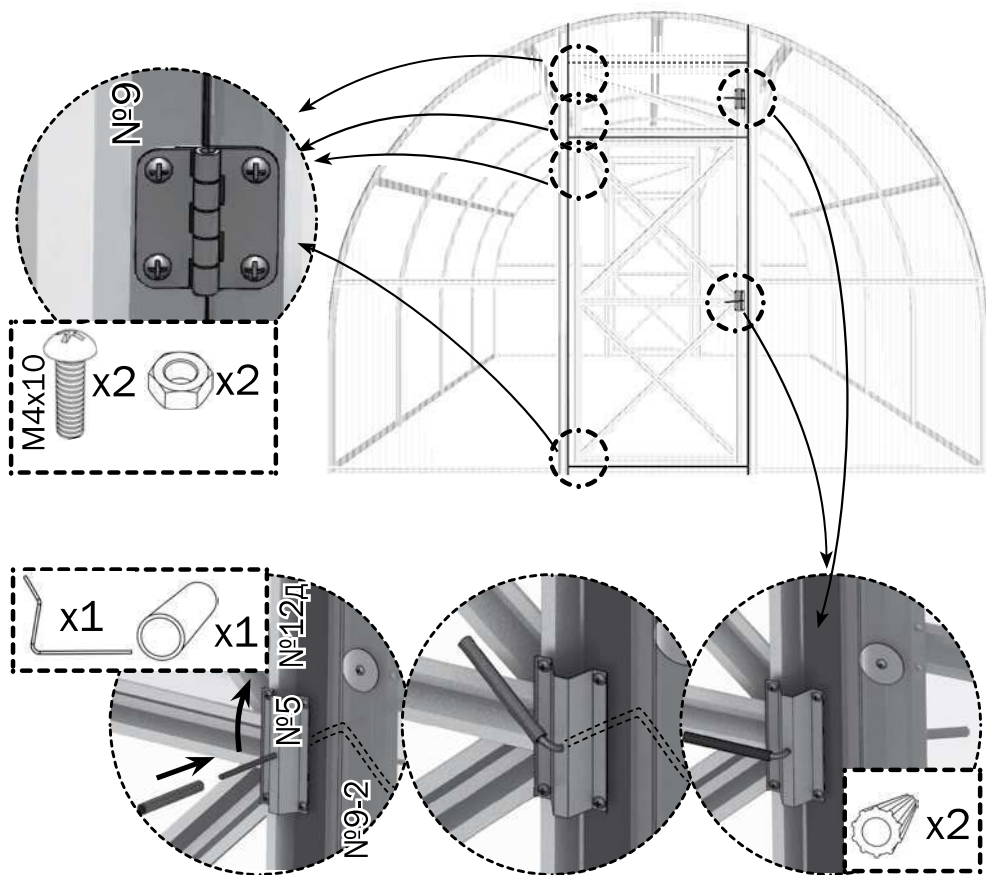

# 20

In basic variant the top of the greenhouse is covered by undivided sheets of cellular polycarbonate 2.1x6 in size with a long direction of sheet mounted along arcs. Near-by sheets are mounted with overlap. Sheets on the frame are fastened the same as on the end surface.

In case of delivery of a greenhouse with an extra package and cut sheets assembly stages 21...27 are to be done.

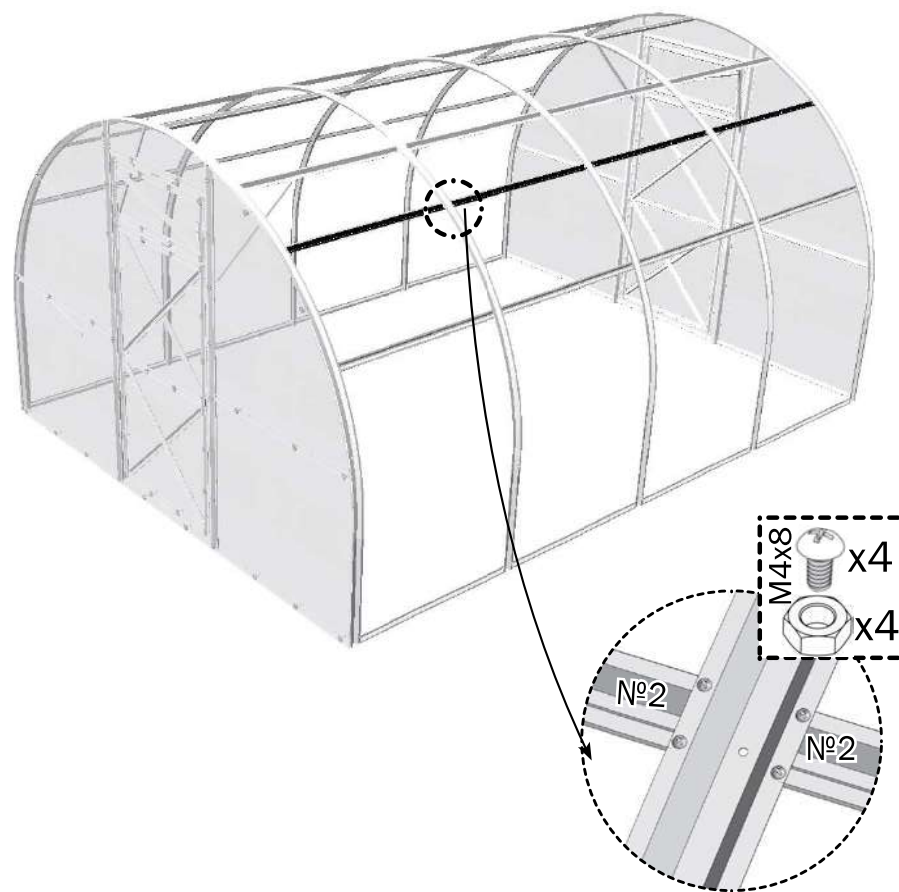

# 21

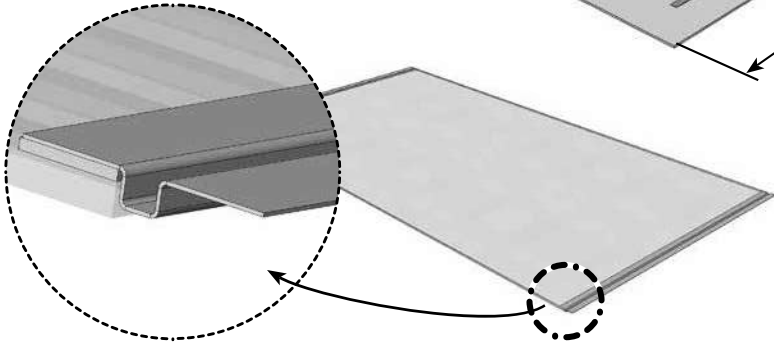
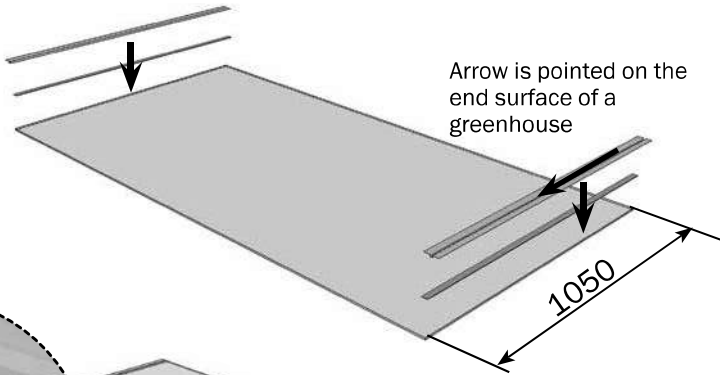
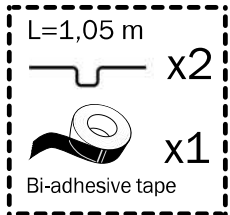
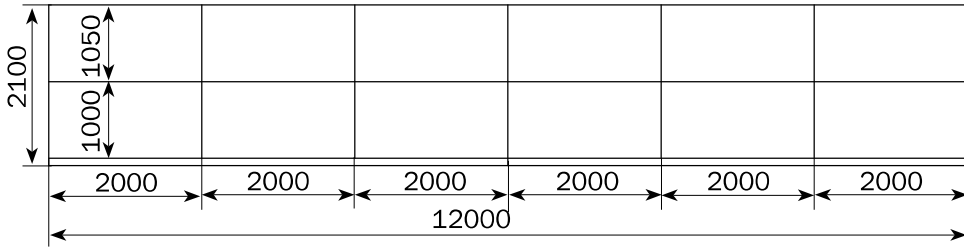

# 22

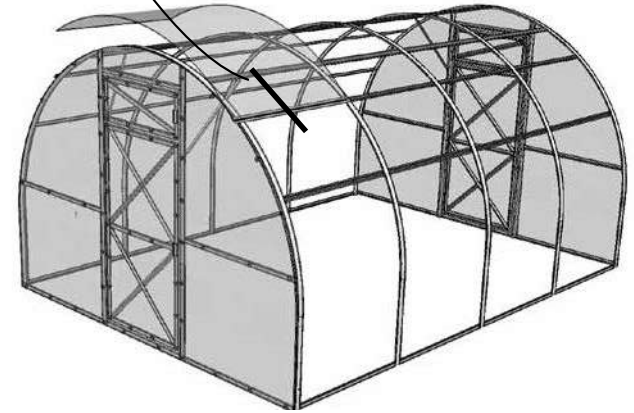
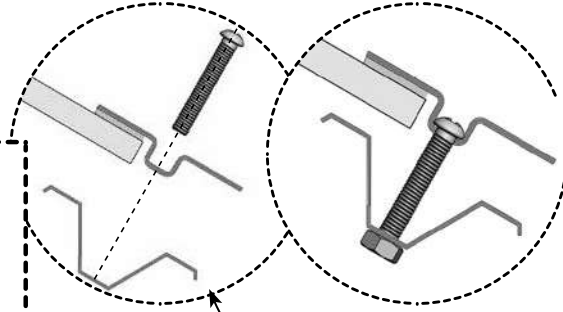
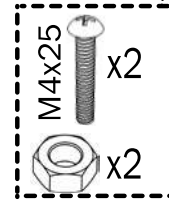

# 23

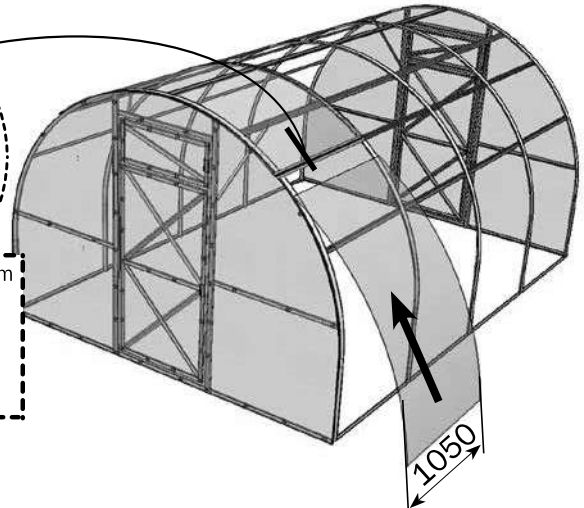
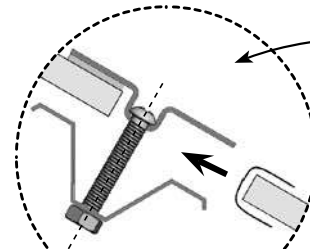



# 24

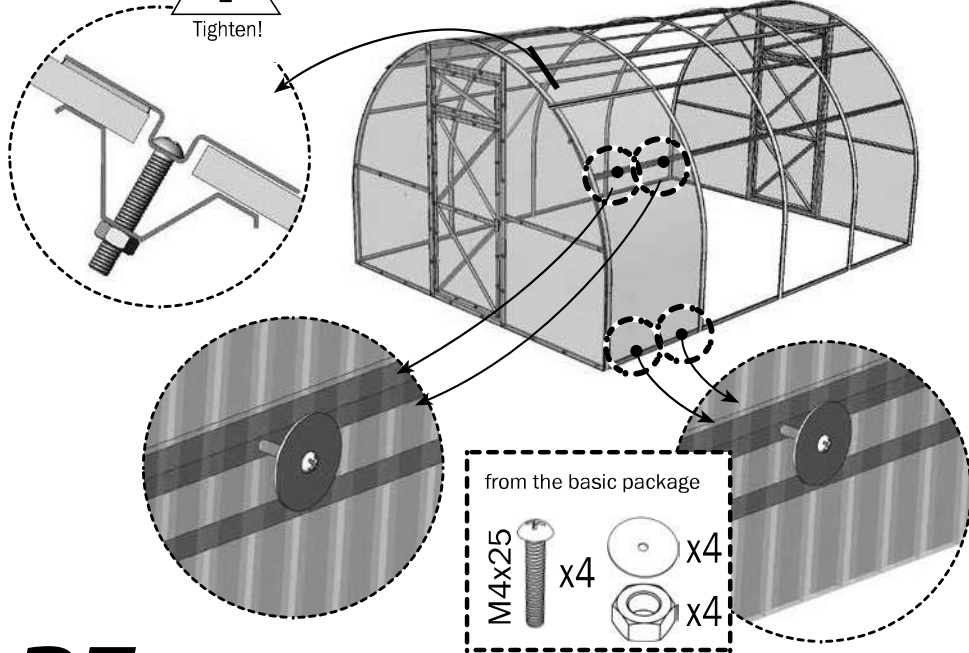

# 25

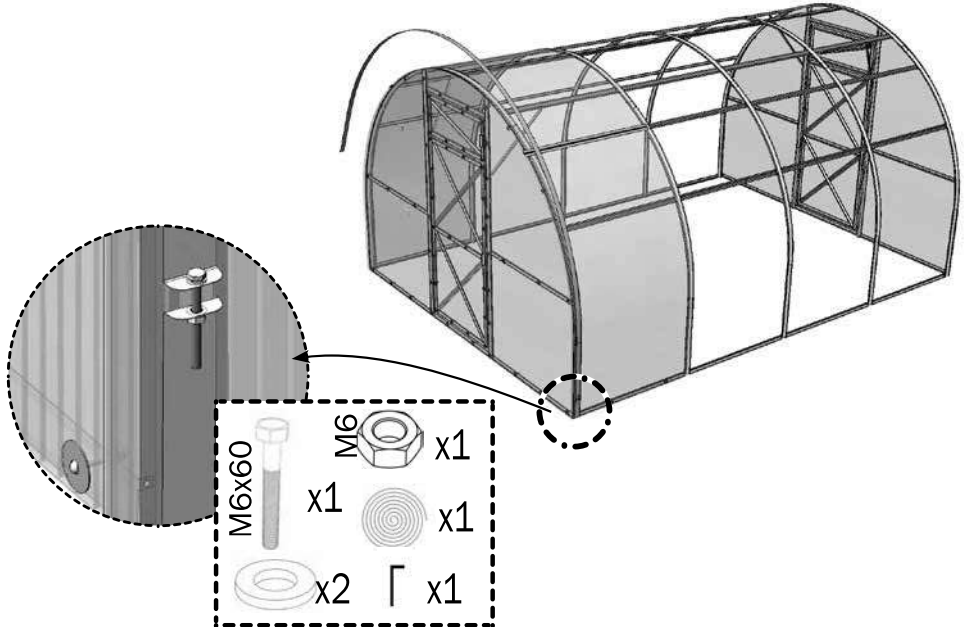

# 26

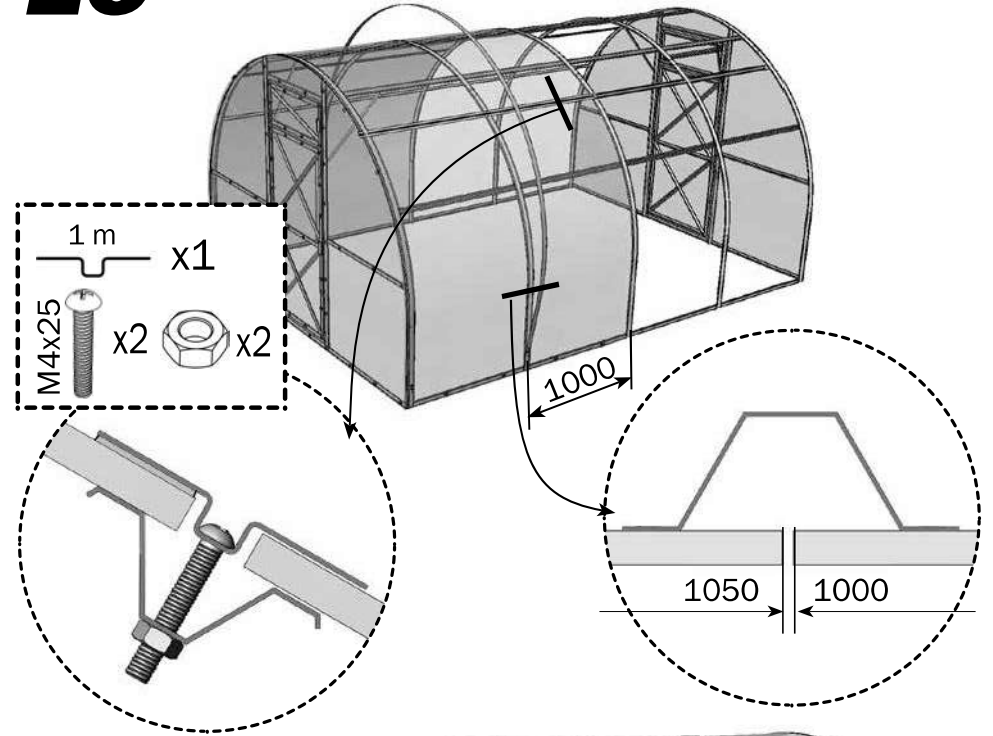

# 27

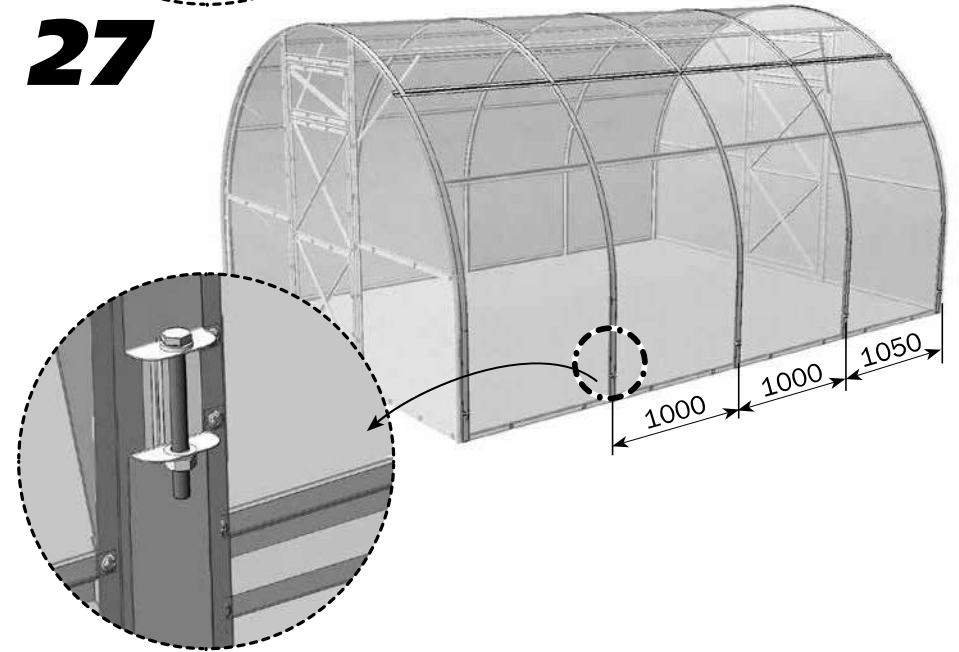

For installing on fundament

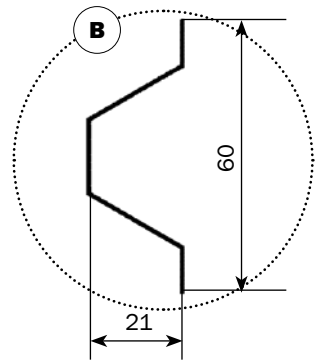
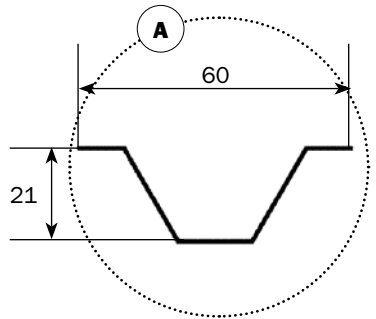
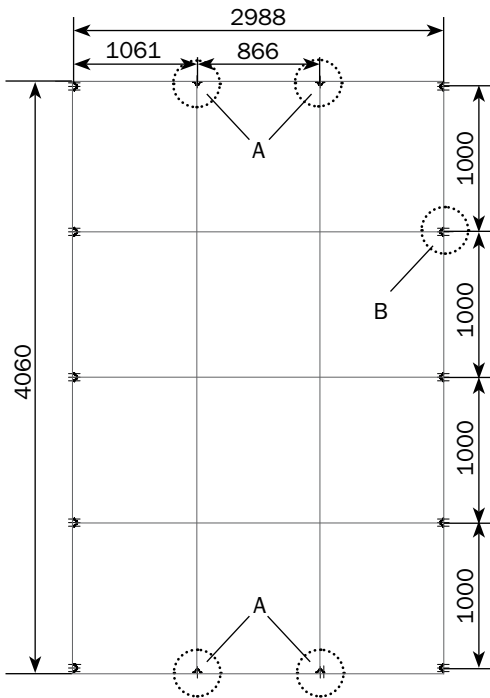
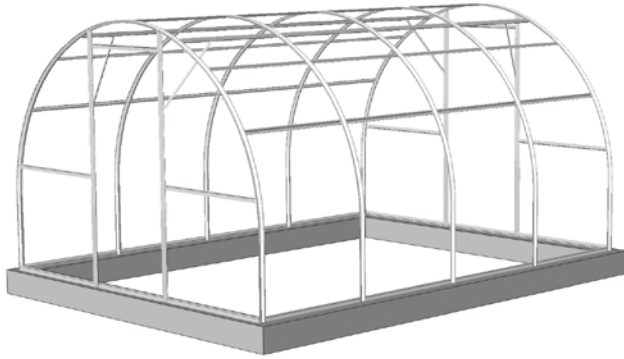

## Contact information

Head office:

Dancover A/S  
Lyngevej 16A, Nørre Herlev  
3400 Hillerød  
Denmark

For more information  
please visit:

[www.dancovershop.com](http://www.dancovershop.com)

## National contact

Denmark:

[denmark@dancover.com](mailto:denmark@dancover.com)

UK:

[uk@dancover.com](mailto:uk@dancover.com)

Germany:

[germany@dancover.com](mailto:germany@dancover.com)

France:

[france@dancover.com](mailto:france@dancover.com)

Sweden:

[sverige@dancover.com](mailto:sverige@dancover.com)

Finland:

[suomi@dancover.com](mailto:suomi@dancover.com)

Poland:

[polska@dancover.com](mailto:polska@dancover.com)

Luxembourg:

[luxembourg@dancover.com](mailto:luxembourg@dancover.com)

Portugal:

[portugal@dancover.com](mailto:portugal@dancover.com)

Spain:

[espana@dancover.com](mailto:espana@dancover.com)

Italy:

[italia@dancover.com](mailto:italia@dancover.com)

Switzerland:

[schweiz@dancover.com](mailto:schweiz@dancover.com)

Austria:

[austria@dancover.com](mailto:austria@dancover.com)

Norway:

[norge@dancover.com](mailto:norge@dancover.com)

Nederland:

[nederland@dancover.com](mailto:nederland@dancover.com)

Ireland:

[ireland@dancover.com](mailto:ireland@dancover.com)

Belgium:

[belgique@dancover.com](mailto:belgique@dancover.com)