

DANCOVER[®]

.com



Manual
for
Polytunnel Greenhouse
2,2x4x1,9m

22-03-2018

DANCOVER[®]

.com

Safety Advice

Attention

In some countries approval is needed to set up a marquee/tent larger than 75 m². It is your responsibility to comply with local rules and regulations and to ensure that the marquee/tent is assembled correctly.

In case of bad weather conditions, it is your responsibility to ensure the marquee/tent is safely secured and that the marquee/tent does not cause damage to others.

Do not use open fire, welding equipment or other sources which can ignite, inside or close to the tent.

The marquee/tent must be safely secured. We recommend you secure your marquee/tent with straps and pegs as soon as it is assembled.

Make sure to check if the marquee/tent is covered by your home contents insurance.

Marquees/tents must be evacuated under extreme weather conditions.

In the event of snow always remove snow from the roof of the marquee/tent regularly to prevent snow from building on the roof as heavy snow can cause the marquee/tent to collapse.

In the event of rain there is a risk of rain puddles building up on top of the roof of the marquee/tent. Heavy rain puddles can cause the roof to collapse. It is your responsibility to ensure rain puddles do not build up. As a precaution, make sure the roof of the marquee/tent is stretched out properly and adequately over the side frames of the marquee/tent and remove rain water regularly.

Do not unpack or repack your marquee/tent in freezing temperatures. In case of temperatures below zero always unpack and repack your marquee/tent indoors to avoid the risk of cracking parts.

The marquee/tent must be totally dry before you repack and store it to avoid mildew.

Note: Marquees are intended for events and other arrangements and are as such only meant for short term temporary assembly and the following disassembly. Dancover warranty applies only to the normal use of the Product, normal wear and tear excepted, in accordance with written use instructions or manual. The warranty does not apply to damage caused by accident, abuse, misuse, or modification of the Product.

Warranty Information

Please visit dancovershop.com for information on warranty.

Please always check our website for the latest safety advice and manual.

Assembly instructions



Min. 10°C



∅ 2 mm



1. The tunnel's frame

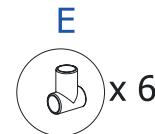
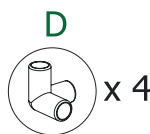
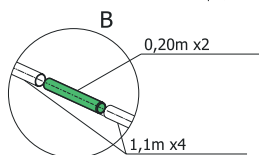
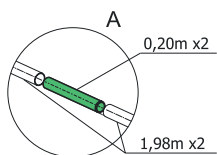
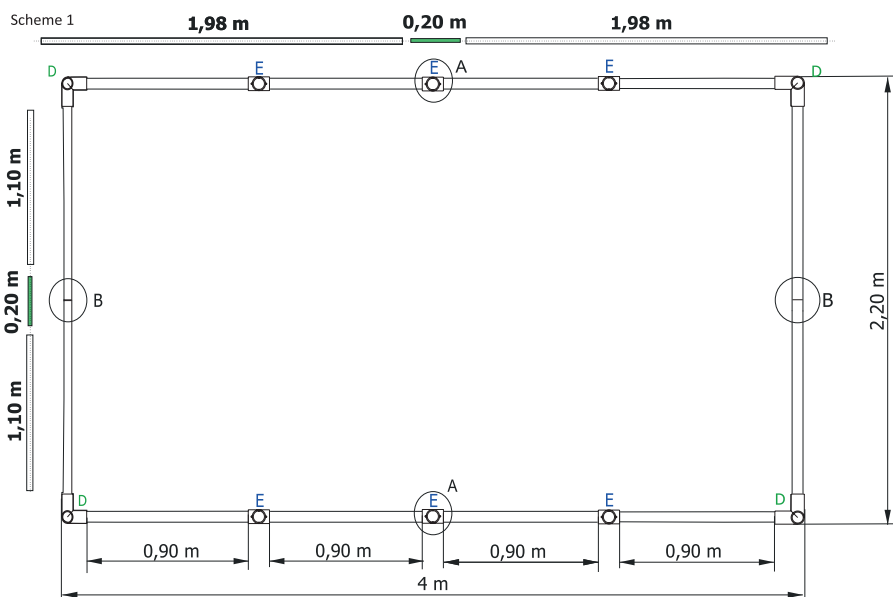

2. The tunnel's bows



Scheme 2a



Scheme 2b

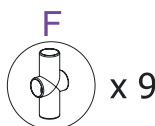
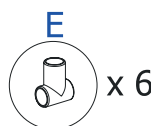
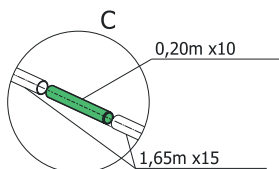
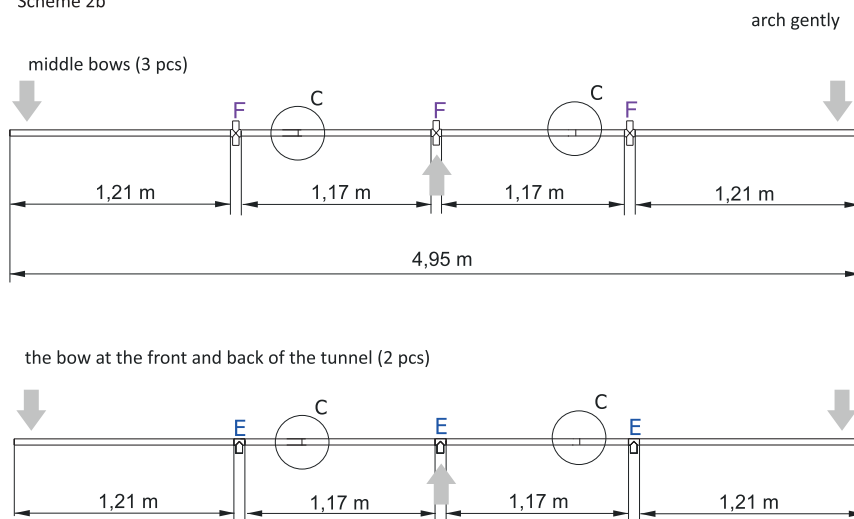

Assembly instructions



Min. 10°C



Ø 2 mm



3. The front and back of the tunnel

Scheme 3

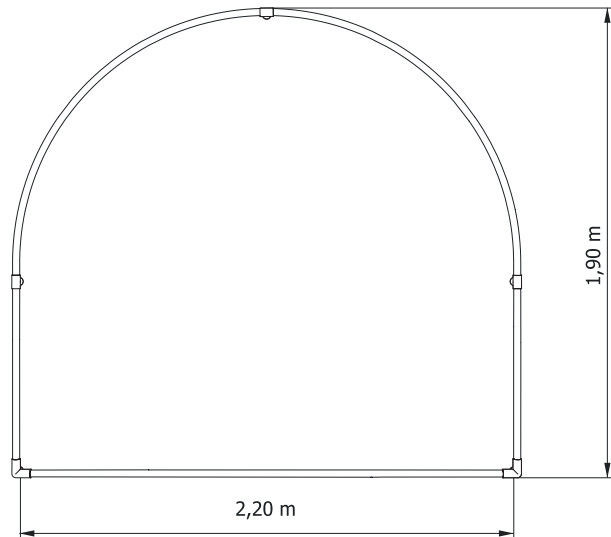

4. Assembly of the foil

Scheme 4

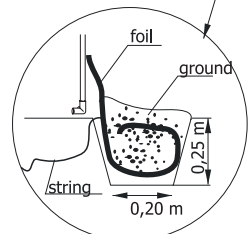
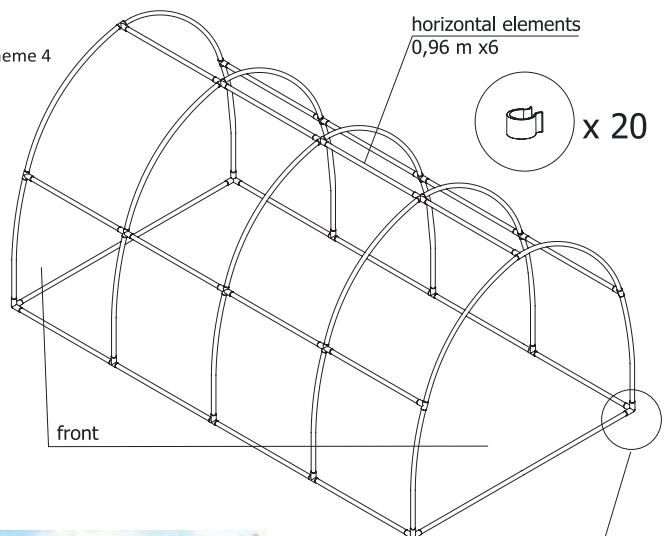
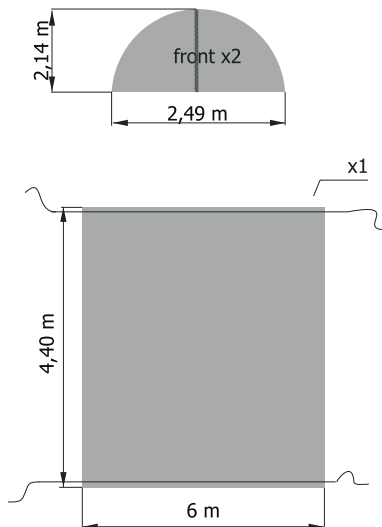
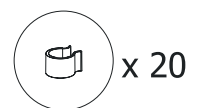

horizontal elements
0,96 m x 6







THE COMPONENTS OF TUNNEL CONSTRUCTION

| | | | | |
|---|--------|---------------------|--------|--------|
|  | 1,98 m | the tunnel's length | T00064 | 4 pcs |
| | 1,65 m | bows | T00062 | 15 pcs |
| | 1,10 m | the tunnel's width | T00058 | 4 pcs |
| | 0,96 m | horizontal elements | T00056 | 12 pcs |

* length tolerance of the tubes is within ± 1 cm

| | | | |
|---|----------------------------|--------|--------|
|  | Corner T-piece | T00001 | 4 pcs |
|  | Tunnel T-piece 32/32/90 | T00005 | 12 pcs |

| | | | |
|---|--|--------|--------|
|  | Four-way tunnel piece | T00004 | 9 pcs |
|  | The pin to foil | T00008 | 20 pcs |
|  | Connecting tube $\varnothing 28 \times 0,2$ m | T00033 | 14 pcs |
|  | Tacks | | 1 op |
|  | Assembly pins | | 10 pcs |

USER'S IMPORTANT INFORMATION

Proper use of the garden tunnel is provided by correct assembly as per the manufacturer's instructions:

1. The tunnel must be carefully assembled, as per the guidelines in the manual.
2. All elements of the tunnel construction should be carefully secured with tacks in the connections from all sides where the tube joins the fitting.
3. The foil should be assembled on sunny and windless days, which will make the work considerably easier. Firm tightening and stable mounting of the foil is very important, which mainly influences the durability of the material.
4. **During winter periods garden foil should be removed from the construction.**
5. In order to secure the tunnel against difficult weather conditions, the users themselves should additionally strengthen the tunnel by sticking metal or wooden poles and fasten them to the bows.
6. In longer tunnels additional reinforcement of the whole construction is recommended, through connection of particular bows in their upper part with the use of an additional tube or a thick wire (the so-called ridge lath)
7. The tunnel's construction may additionally be reinforced using polypropylenic string that will be winding crossly the tunnel's surface and that will be fastened to the metal hooks at the ground.
8. Don't leave the tunnel opened at strong wind, because it may cause the damage of particular parts of the tunnel.
9. One should not attach the strings supporting the plants to the bows, because it may cause the damage of particular parts of the tunnel.
10. The garden tunnel should not be placed in the open space. It should be placed near the buildings or trees and bushes.
11. During the assembly the ambient temperature should not be lower than 10°C.

THE MANUFACTURER is not responsible for improper use of the tunnel, other than intended use and for the damages that occurred as a result of extreme weather conditions, such as strong wind, hailstorm, snow etc.

 Three-layered foil

Internal layer ensures increased thermal insulation properties, which results in keeping greater amount of thermal radiation inside the tunnel.

External layers ensure:

proper elasticity, increased durability and resistance to damages and perfect permeability of light.

Advantages of three-layered foil

- perfect mechanic durability (addition of metallocene)
- perfect permeability of daylight
- high elasticity and resistance to low temperatures
- ensuring the greenhouse effect

How to use the tacks to secure the tunnel construction

Drill the holes with a 2 mm diameter drill and insert the attached nails on each joint of the pipe with the fitting on both sides.



Contact information

Head office:

Dancover A/S
Nordre Strandvej 119 G
3150 Hellebæk
Denmark

For more information
please visit:
www.dancovershop.com

National contact

Denmark: 70 26 76 20
denmark@dancover.com

UK: 020 8099 7570
uk@dancover.com

Germany: 041 0266 7040
germany@dancover.com

France: 0975 181 800
france@dancover.com

Sweden: 040 233 262
sverige@dancover.com

Finland: 0 931 581 720
suomi@dancover.com

Poland: 22 300 8602
polska@dancover.com

Luxembourg: +49 041 0266 7040
luxembourg@dancover.com

Portugal: 308 800 899
portugal@dancover.com

Spain: 911 436 828
espana@dancover.com

Italy: 02 479 21 198
italia@dancover.com

Switzerland: 0840 000125
schweiz@dancover.com

Austria: 0662 626935
austria@dancover.com

Norway: 231 00 690
norge@dancover.com

Nederland: 0 858 880 524
nederland@dancover.com

Ireland: 0 151 33 003
ireland@dancover.com

Belgium: 0 28 08 08 09
belgique@dancover.com