

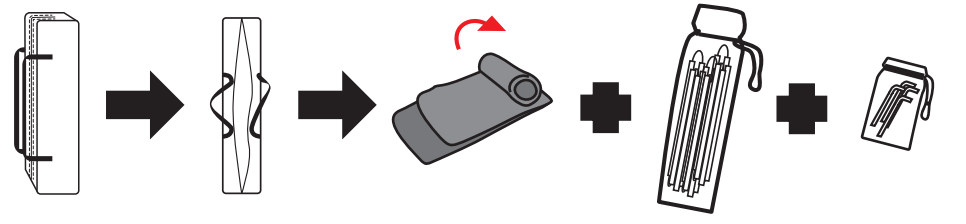

0 - CHECK LIST

COOK 6



The checklist diagram shows the components of the tent: a rolled-up tent bag, a bundle of poles, and a pack of stakes. Arrows indicate the items are to be checked and ready for use.

1 - SET UP

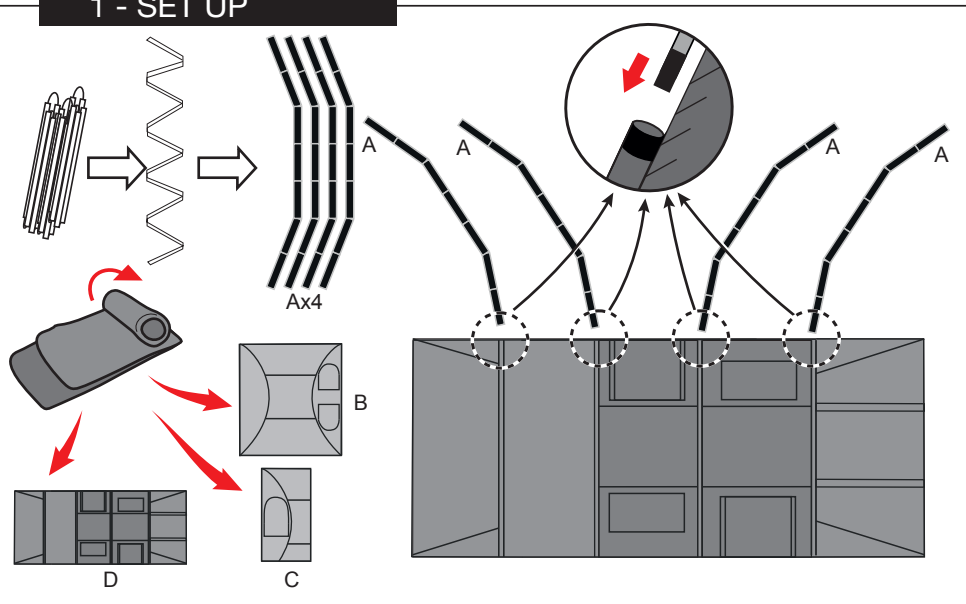

This diagram illustrates the first step of setting up the tent. It shows the tent body with four attachment points labeled 'A'. The poles are inserted into these points. A circular inset shows a close-up of the pole being pushed into the sleeve. Other parts of the tent, labeled B, C, and D, are shown separately, indicating they will be attached in subsequent steps.

2 - SET UP

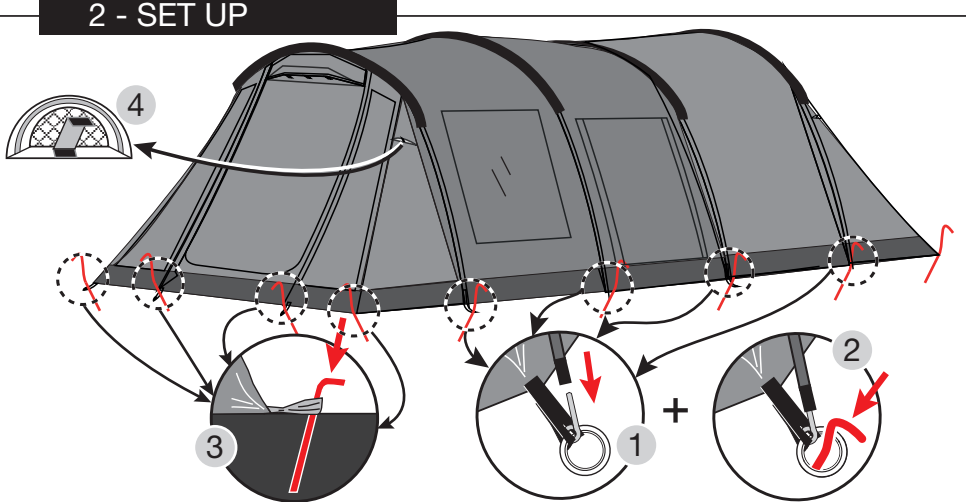

This diagram shows the tent being pitched. The tent body is lifted and secured to the ground using stakes. A circular inset labeled '3' shows a stake being driven into the ground. Another inset labeled '2' shows a stake being inserted into a ring on the tent's edge. A fourth inset labeled '4' shows the tent's flysheet being attached to the main body.

3 - SET UP

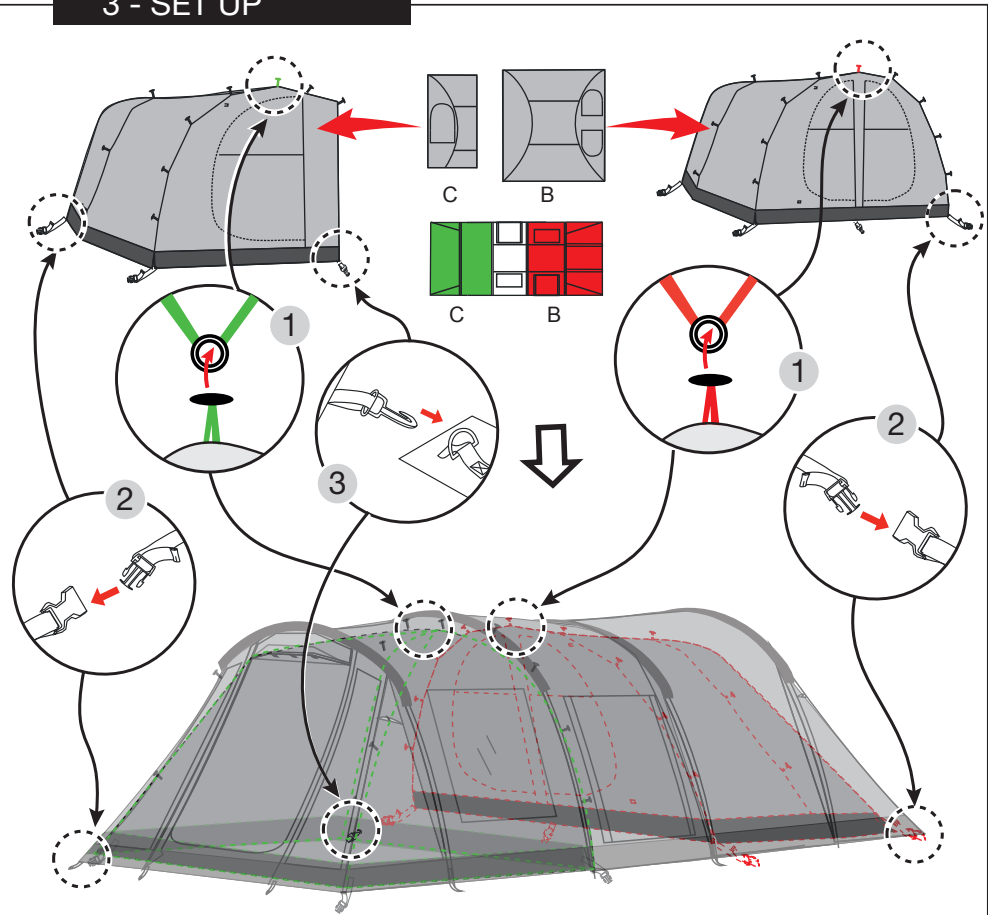

This diagram illustrates the third step of setting up the tent, which is attaching the flysheet. The flysheet is shown being placed over the tent body. A circular inset labeled '1' shows the flysheet being secured to the tent's frame. Another inset labeled '2' shows the flysheet being attached to the ground using stakes. A third inset labeled '3' shows the flysheet being secured to the tent's body. The diagram also shows the flysheet being attached to the tent's body using clips labeled B and C.

4 - SET UP

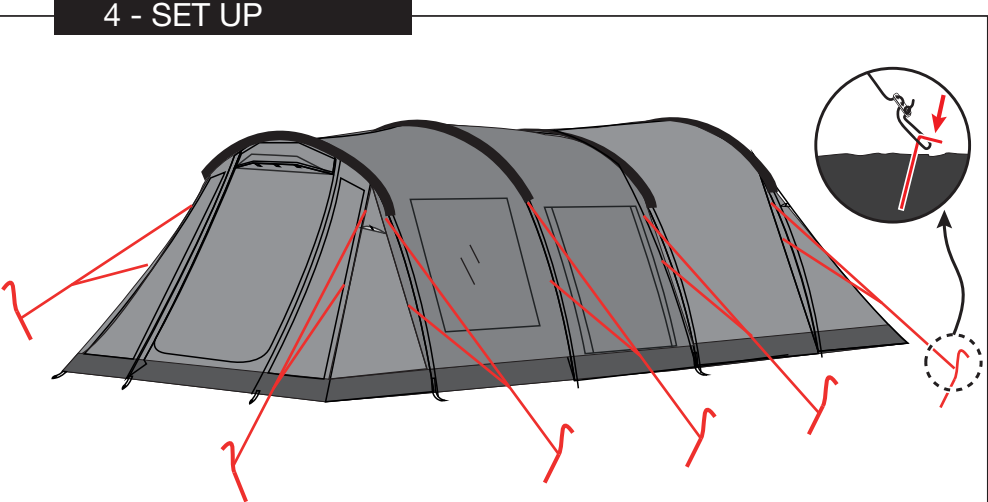

This diagram shows the final step of setting up the tent, which is the final structure. The tent is fully pitched and secured to the ground. A circular inset shows a close-up of a stake being driven into the ground to secure the tent's edge.

1 - SET DOWN

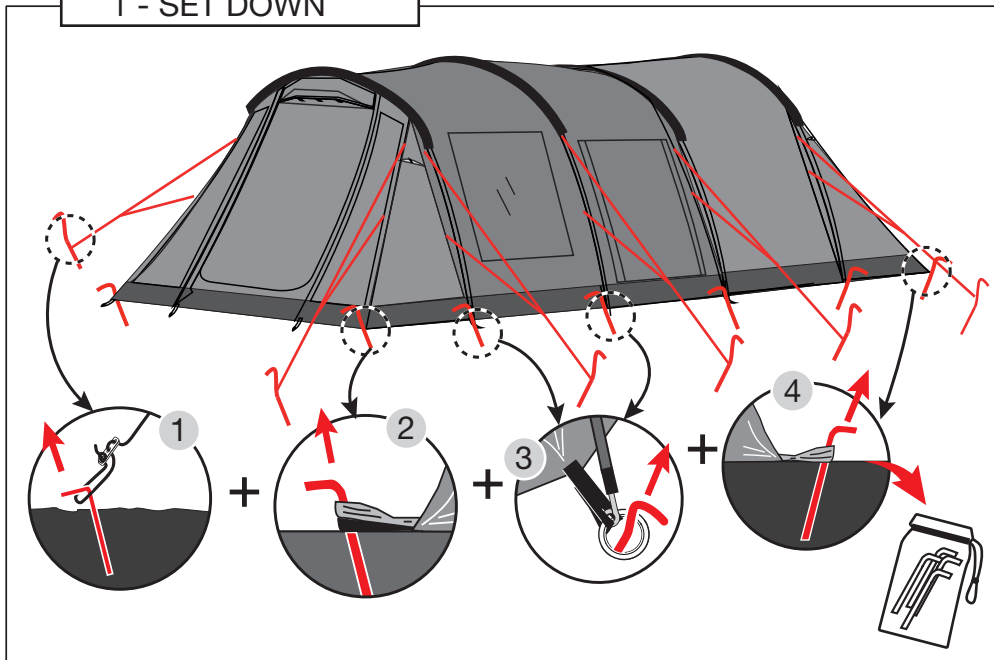

2 - SET DOWN

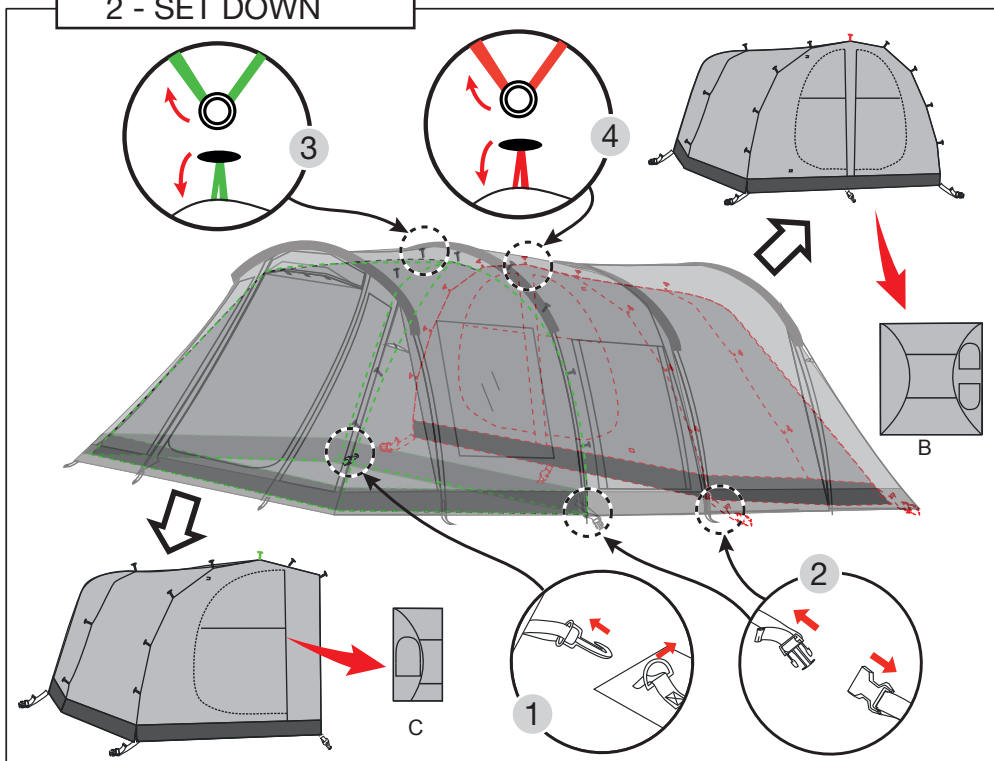

3 - SET DOWN

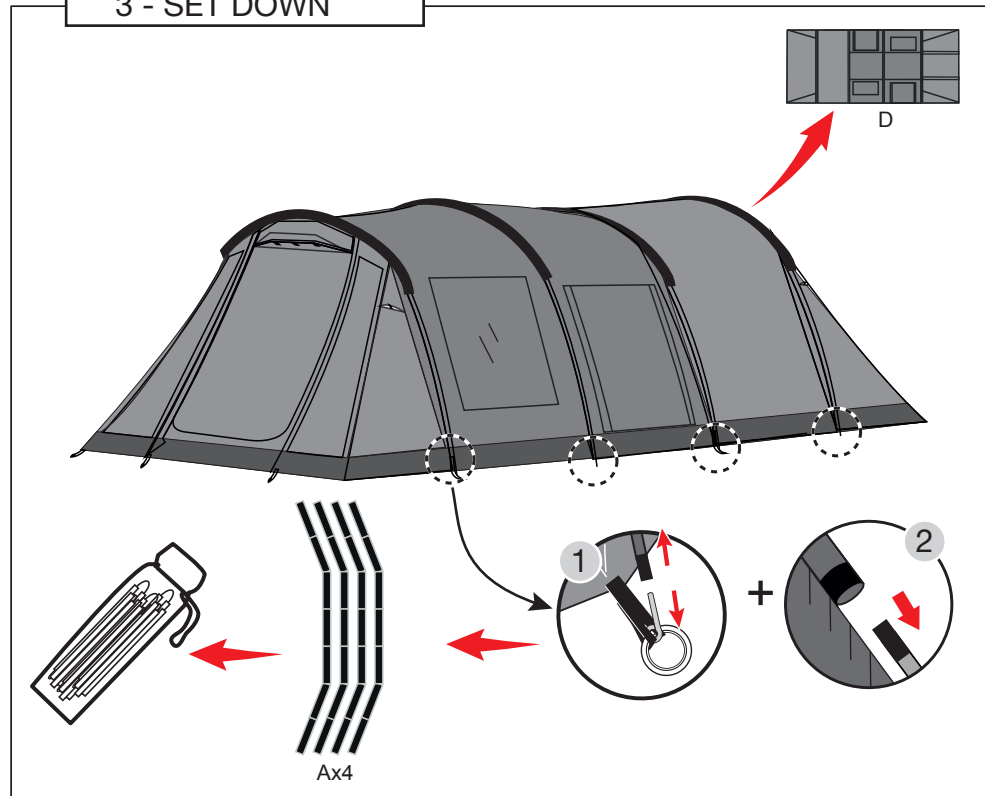

4 - SET DOWN

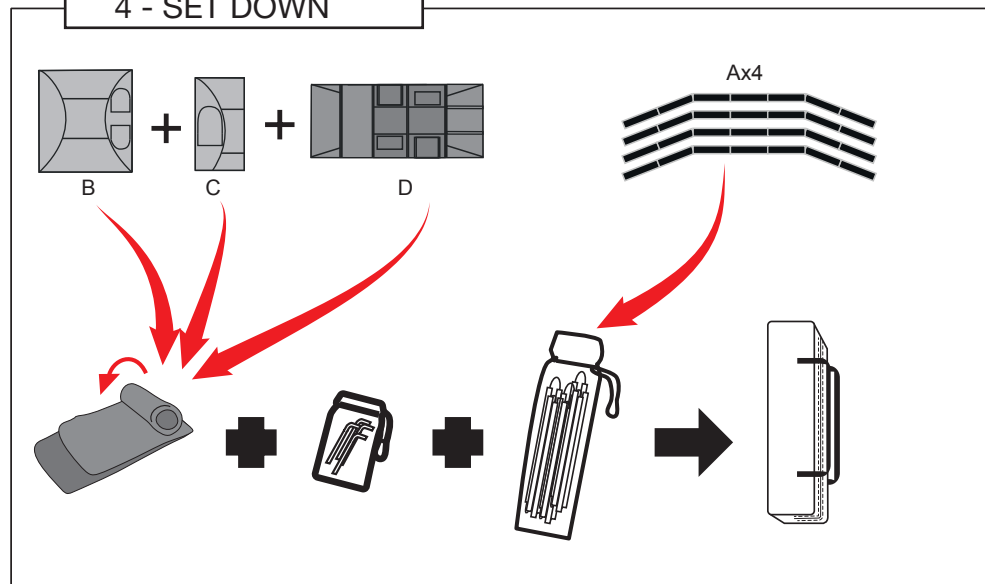

Stitch Line

Stitch Line

Warning-Attention-Achtung-Waarschuwing-Advarsler-Advarsel-Varning-Upozornění-Attenzione-Advertencia-Atenção-Varoitus-Uwaga-Upozornienie-Opozorilo-Upozorenje-Figyelmeztetés-Предупреждение-Atenție-Ispėjimas-Внимание-Ноиatus-Brīdinājums-Προειδοποίηση-
-Uyarı - راذح

- GB** Make sure your tent is dry before packing
Store in a dry and well ventilated area
- FR** Vérifiez que votre tente est bien sèche avant de la ranger
Ranger en lieu sec et bien ventilé
- DE** Überprüfen Sie vor dem Wegräumen, dass ihr Zelt wirklich trocken ist
An einem trockenen und gut durchlüfteten Ort aufbewahren
- NL** Zorg ervoor dat uw tent droog is voordat u ze inpakt
Bewaar de tent op een droge en goed verluchte plaats
- IT** Verificate che la tenda sia perfettamente asciutta prima di riporla
Riporre in luogo asciutto e ben ventilato
- ES** Compruebe que la tienda de campaña esté seca antes de guardarla.
Guárdela en un lugar seco y bien ventilado
- PT** Certifique-se que a tenda está seca antes de a embalar.
Guardar em local seco e bem ventilado
- CZ** Před zabaléním se ujistěte, že je vš stan suchý.
Skladujte na suchém a dobře větraném místě.
- FI** Varmista, että teltta on kuivunut ennen kuin pakkaat sen
Säilytä kuivassa ja hyvin tuuletetussa paikassa
- DK** Sørg for, at dit telt er tørt, før du pakker det.
Opbevar på et tørt og godt ventileret sted
- SE** Se till att Ditt tält är torrt innan det packas
Förvara i torrt och väl ventilerat utrymme
- NO** Sørg for at teltet ditt er tørt før du pakker det sammen
Lagres på et tørt og godt ventilert sted.
- PL** Przed złożeniem należy sprawdzić, czy namiot jest suchy
Przechowywać w suchym i dobrze wietrzonym miejscu
- SI** Šotor mora biti pred pakiranjem suh
Hranite v suhem in dobro prezračnem prostoru
- SK** Pred zbalením skontrolujte, či je stan vyschnutý
Skladujte na suchom a dobre vetranom mieste
- HU** Becsomagolás előtt győződjön meg arról, hogy a sátor megszáradt
Száras, jól szellőző helyen tárolandó
- HR** Uvjerite se da je vaš šator osušen prije pakiranja
Pohraniti na suhom i dobro prozračenom području
- RU** Перед тем как упаковывать тент, убедитесь в том, что он высох.
Храните в сухом и хорошо проветриваемом месте
- BG** Преди опаковане се уверете, че палатката е суха
Съхранявайте на сухо и добре проветрено място
- RO** Înainte de împachetare, asigurați-vă că cortul este uscat.
Depozitați într-un loc uscat și bine ventilat
- EE** Kontrollige, et telk oleks enne pakkimist kuiv.
Hoida kuivas ja hästi õhutatud kohas
- LV** Pārlicinieties, ka pirms salikšanas jūsu telts ir sausa
Uzglabāt sausā, labi vēdināmā vietā
- LT** Prieš supakuodami įsitikinkite, ar jūsų palapinė išdžiuvusi
Saugoti sausoje ir gerai vėdinamoje vietoje
- GR** Βεβαιωθείτε ότι η σκηνή σας είναι στεγνή πριν την πακετάρετε.
Αποθηκεύστε τη σκηνή σε στεγνή περιοχή με καλό εξαερισμό.
- TR** Çadırınızı paketlemeden önce kuru olduğundan emin olun
Kuru ve iyi havalandırılan yerde saklayın
- AR** تأكد من جفاف خيمتك قبل حزمها.
يتم التخزين في مكان جاف ومتهوية جيداً.